

REV.	MODIFICATION.	DATE	DRN
01	NEW DRAWING	28/06/01	KD
02	SCN2001-124	05/12/01	KD
03	SCN2002-015	08/02/02	KD
04	ECN2005-076	28/06/05	OW
05	ECN2005-092	30/08/05	TC
06	ECN2006-027	17/03/06	OW
07	ECN2007-031	08/02/07	SF
08	ECN2007-040	14/02/07	OW
09	ECN2007-046	15/02/07	SF
10	ECN2007-197	14/11/07	SF
11	CO2011253	12/04/12	SF

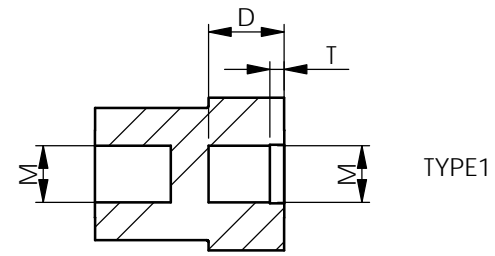

SECTION A-A  
SCALE 2.5 : 1

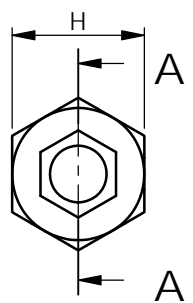
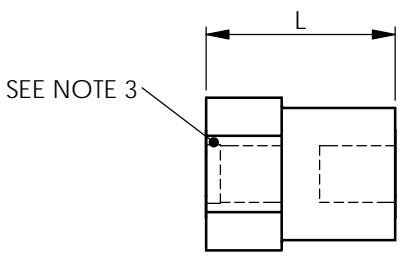
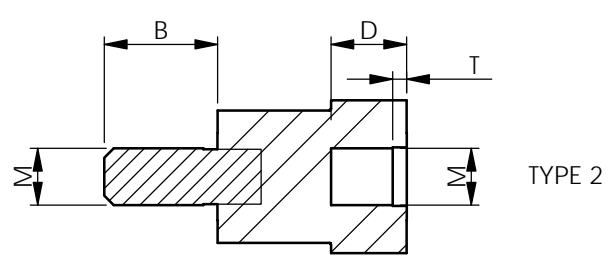
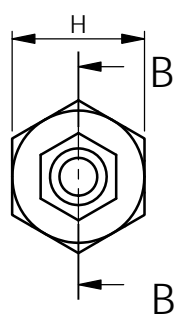
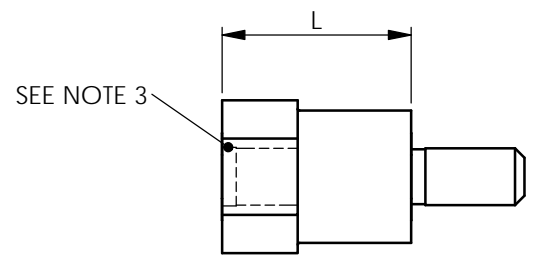

SECTION B-B  
SCALE 2.5 : 1

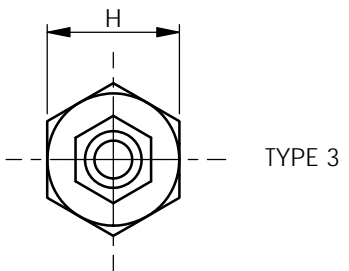
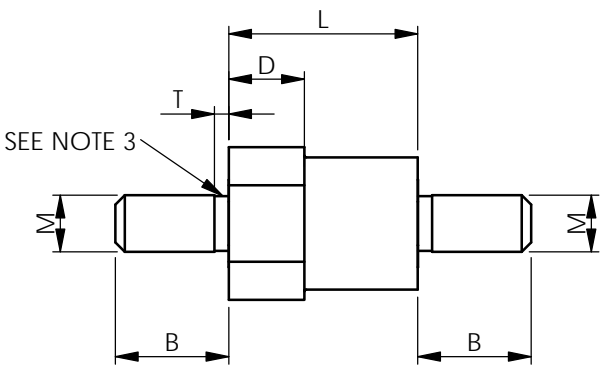

NOTES

- 1) METRIC PRIMARY UNITS: mm  
IMPERIAL SECONDARY UNITS: [inches]
- 2) INSERT & STUD MATERIAL = BRASS(RMS-231) - NICKEL PLATING (RMS-229)  
BODY MATERIAL = NYLON 6 - WHITE (RMS-133)  
(Parts available in UL94-V0 material by special order)
- 3) UNTHREADED LENGTH = 1.5 PITCH MAX
- 4) ALL MATERIALS TO COMPLY TO RESTRICTION OF HAZARDOUS SUBSTANCES (RoHS) EUROPEAN UNION DIRECTIVE

INFORMATION CONTAINED IN THIS DOCUMENT IS CONFIDENTIAL TO RICHCO INTERNATIONAL Co. Ltd. AND MAY NOT BE DISCLOSED OR REPRODUCED IN WHOLE OR PART WITHOUT THEIR WRITTEN CONSENT.

**RICHCO, INC.**  
WWW.RICHCO-INC.COM

GENERAL TOLERANCES ±0.25 [0.010]  
UNLESS OTHERWISE STATED  
1 DECIMAL PLACE ±  
2 DECIMAL PLACES ±  
ANGULAR ±1°



PART NUMBER	M	H	B	D	T	LENGTH(L)
MTNSP-M2.5-L-3	M2.5	6[.236]	6[.236]	-	-	4-12[.158-.472] (1mm INCREMENTS)
MTNSP-M2.5-L-2				4[.158]	.68[.027]	7-12[.276-.472] (1mm INCREMENTS)
MTNSP-M2.5-L-1				-	-	9-12[.354-.472] (1mm INCREMENTS)
MTNSP-M3-L-3	M3	7[.276]	6[.236]	-	-	4-12[.158-.472] (1mm INCREMENTS)
MTNSP-M3-L-2				4[.158]	.75[.030]	7-12[.276-.472] (1mm INCREMENTS)
MTNSP-M3-L-1				-	-	9-12[.354-.472] (1mm INCREMENTS)

MATERIAL:		SEE NOTE 2		COLOUR:		SEE NOTE 2	
DESCRIPTION:				MTNSP-MX-H-L-TYPE		PART No:	
				SEE TABLE			
DRG No:		3060070		NPR No:		N/A	
SHEET SIZE		A4		DRG No:		3060070	
DATE		28/06/05		CHKD		NBr	
DATE		28/06/05		SCALE		NTS	
SHEET No.		1 OF 1		DRN		OW	