

C3225CH2E473K250AA

TDK Item Description : C3225CH2E473KT****



Application & Main Feature

Commercial Grade (Mid Voltage (100 to 630V))

Series

C3225 [EIA CC1210]

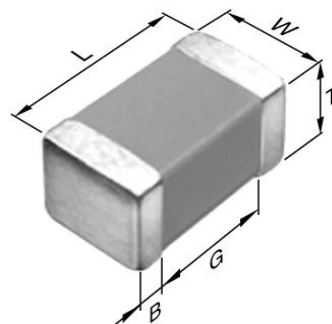

Dimensions

L 3.20mm +/-0.4mm
 W 2.50mm +/-0.3mm
 T 2.50mm +/-0.3mm
 B 0.20mm Min.
 G

Temperature Characteristic

CH (-25 to 85 degC 0+/-60ppm/degC)

Rated Voltage

2E (250Vdc)

Capacitance

47nF

Capacitance Tolerance

K (+/-10%)

Q Factor

1000 Min.

Insulation Resistance

10Gohm Min.

AEC-Q200

Not Applicable

|Z|, ESR vs. Freq. Characteristics

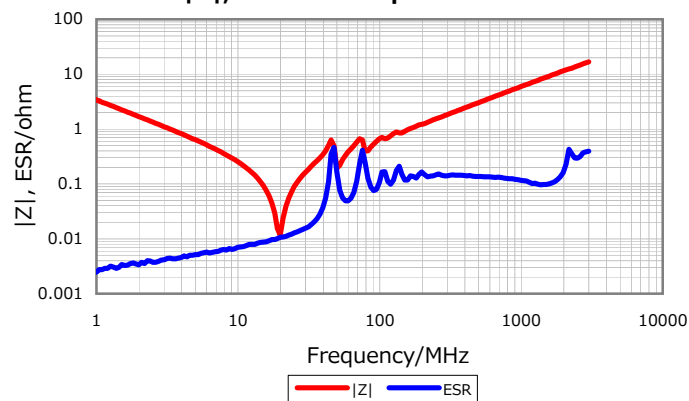

DC Bias Characteristic

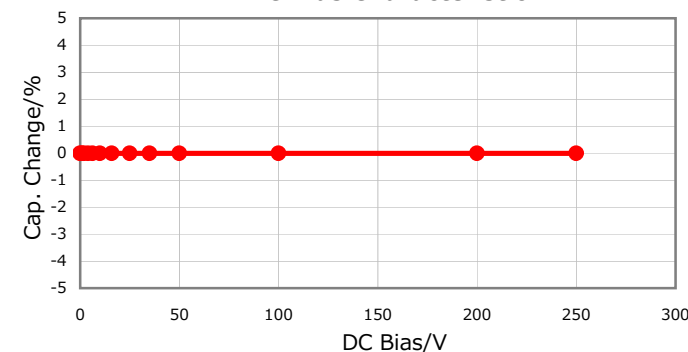

Cap. vs. Freq. Characteristic

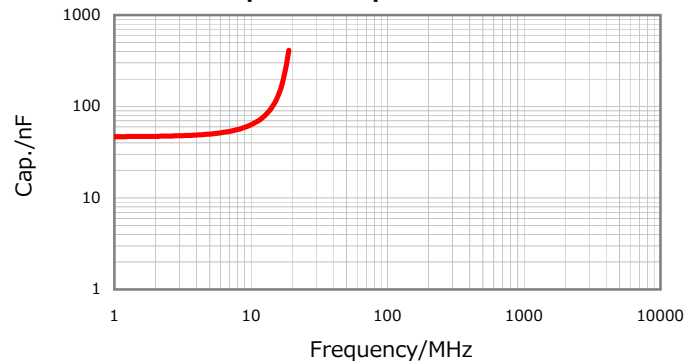

Temperature Characteristics

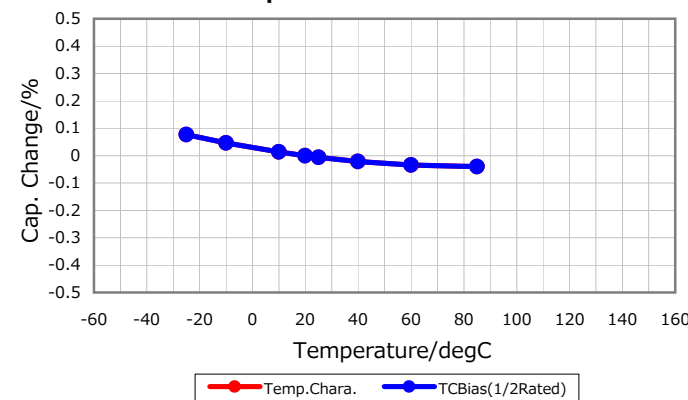

Characterization Sheet (Multilayer Ceramic Chip Capacitors)



All specifications are subject to change without notice.

January 4, 2016