

## LXP3-D

~14° diffused spot beam optimized for CREE XP-E. 14.7 mm high assembly.

### TECHNICAL SPECIFICATIONS:

Dimensions	Ø 21.6 mm
Height	14.7 mm
Fastening	glue
Colour	white
Box size	480 x 280 x 300 mm
Box weight	9 kg
Quantity in Box	1680 pcs
ROHS compliant	yes ⓘ



### MATERIAL SPECIFICATIONS:

Component	Type	Material	Colour
LXP2-D	Lens	PMMA	clear
LXP3-LH1-WHT	Holder	PC	white

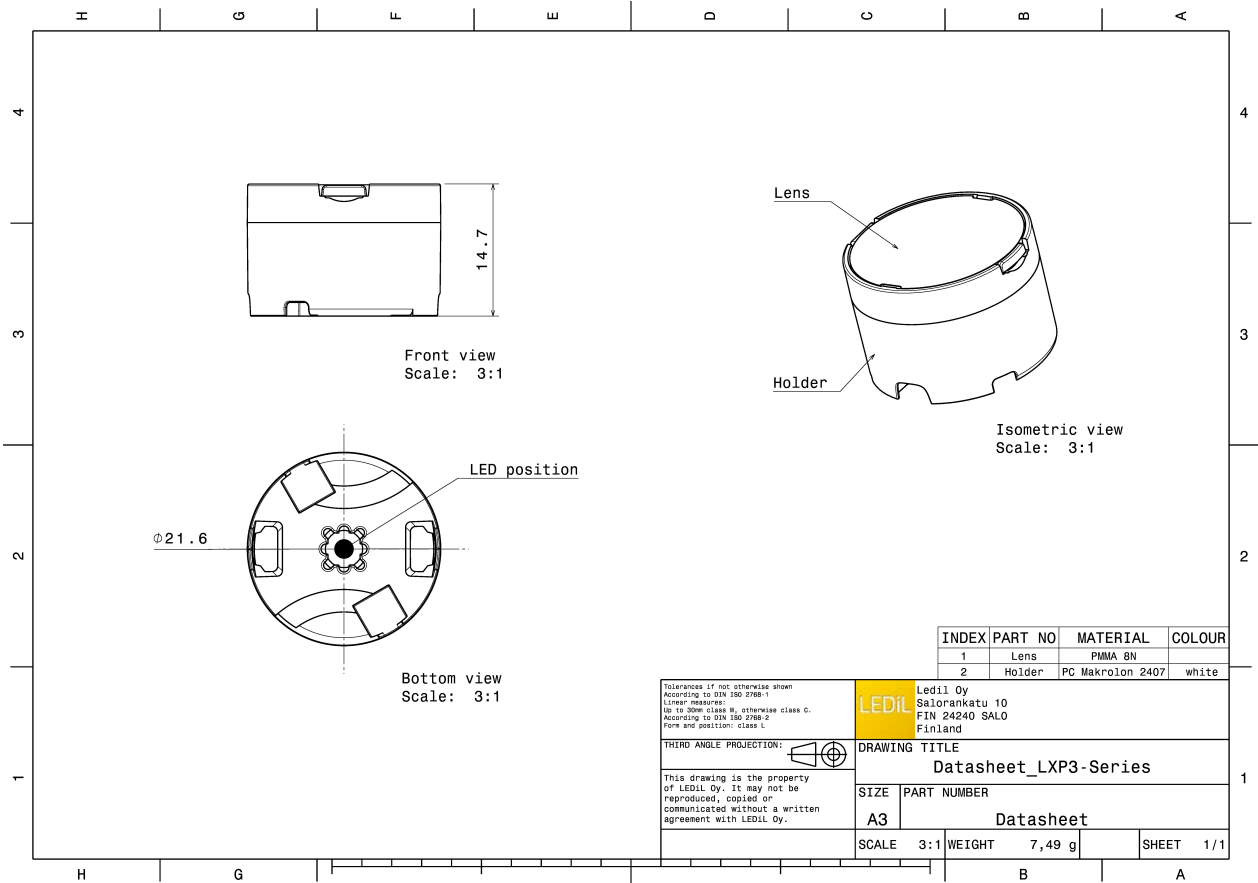

#### PHOTOMETRIC DATA (MEASURED):

**CREE** 

LED XP-E  
 FWHM 13.0°  
 Efficiency 94 %  
 Peak intensity cd/lm  
 Required components:

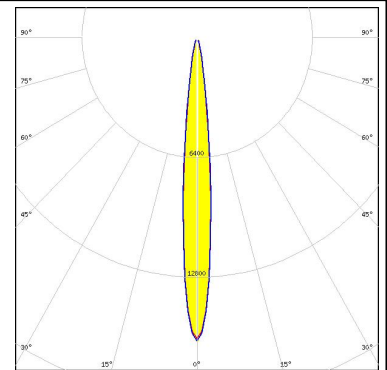

**CREE** 

LED XP-G  
 FWHM 11.0°  
 Efficiency 94 %  
 Peak intensity 11.000 cd/lm  
 Required components:

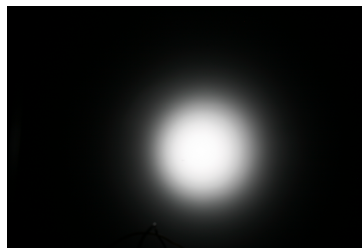

**CREE** 

LED XP-G2  
 FWHM 13.0°  
 Efficiency 92 %  
 Peak intensity 13.800 cd/lm  
 Required components:

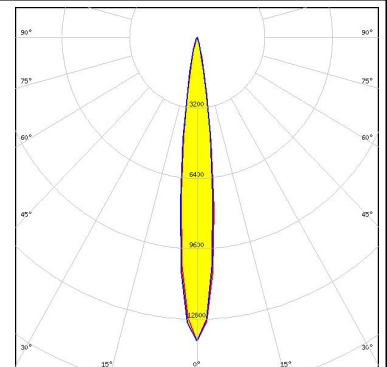

**CREE** 

LED XP-L HI  
 FWHM 14.0°  
 Efficiency 91 %  
 Peak intensity 9.500 cd/lm  
 Required components:

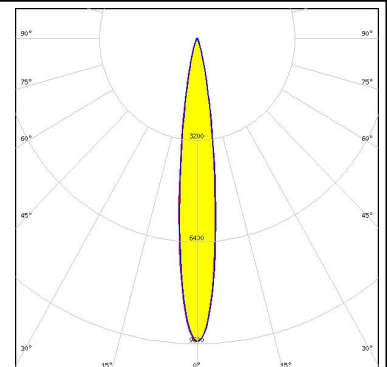
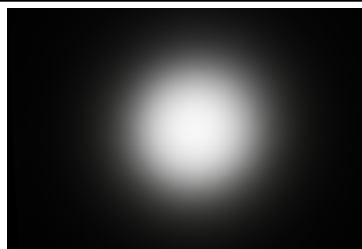

#### PHOTOMETRIC DATA (MEASURED):

**CREE** 

LED XT-E  
FWHM 11.0°  
Efficiency %  
Peak intensity 8.950 cd/lm  
Required components:

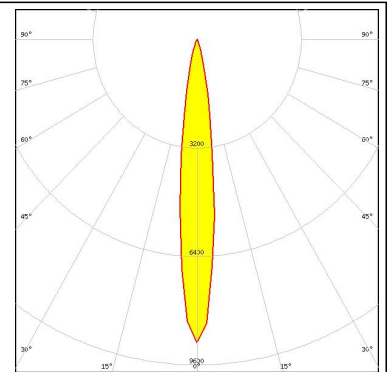

**TOSHIBA**  
Leading Innovation >>>

LED TL1L4  
FWHM 14.0°  
Efficiency 92 %  
Peak intensity 7.900 cd/lm  
Required components:

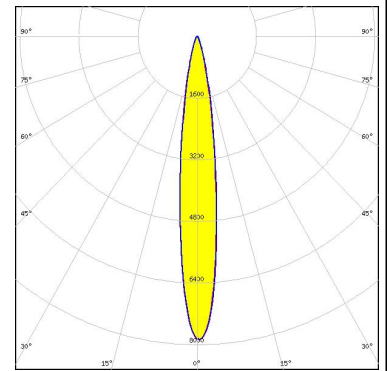
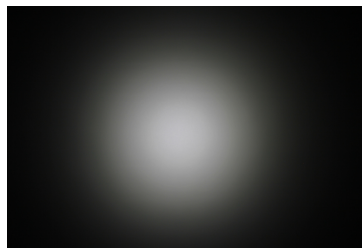

## PHOTOMETRIC DATA (SIMULATED):

	
SEOUL SEMICONDUCTOR	
LED	Z5
FWHM	13.0°
Efficiency	%
Peak intensity	cd/lm
Required components:	

### GENERAL INFORMATION:

NOTE: The typical beam angle will be changed by different color, chip size and chip position tolerance. The typical total beam angle is the full angle measured where the luminous intensity is half of the peak value.

### MATERIALS:

As part of our continuous research and improvement processes, and to ensure the best possible quality and availability of our products, LEDiL reserves the right to change material grades without notice.

### PRODUCT DATA USER AGREEMENT AND DISCLAIMER:

The measured data in the provided downloadable LEDiL Product Datasheets and Mechanical 2D-Drawings is rounded and provided as reference for planning. LEDiL Oy's optical specifications have been verified by conducting performance testing of the products in accordance with the company's quality system. The reported data are averaged results of multiple measurements with typical variation. LEDiL Oy reserves the right to without prior notification make changes and improvements to its products.

LEDiL Oy assumes neither warranty, nor guarantee nor any other liability of any kind for the contents and correctness of the provided data. The provided data has been generated with highest diligence but the provided data may in reality not represent the complete possible variation range of all intrinsic parameters. Therefore, in certain cases a deviation from the provided data could occur.

LEDiL Oy reserves the right to undertake technical changes of its products without further notification which could lead to changes in the provided data. LEDiL Oy assumes no liability of any kind for the possible deviation from any provided data or any other damage resulting from the usage of the provided data.

The user agrees to this disclaimer and user agreement with the download or usage of the provided files.

#### LEDiL Oy

Joensuunkatu 13  
FI-24240 SALO  
Finland

#### LEDiL Inc.

228 West Page Street  
Suite D  
Sycamore IL 60178  
USA

#### Local sales and technical support

[www.ledil.com/  
where\\_to\\_buy](http://www.ledil.com/where_to_buy)

#### Shipping locations

Salo, Finland  
Hong Kong, China

#### Distribution Partners

[www.ledil.com/  
where\\_to\\_buy](http://www.ledil.com/where_to_buy)