

Schottky Barrier Rectifier

High Barrier Technology for Improved High Temperature Performance

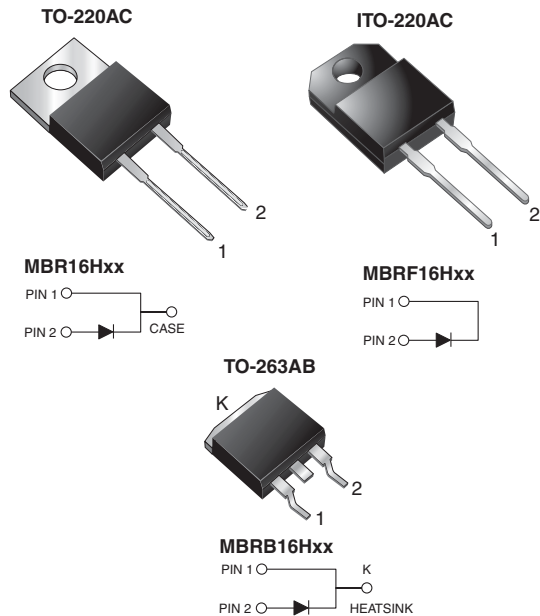

FEATURES

- Power pack
- Guardring for overvoltage protection
- Low power loss, high efficiency
- Low forward voltage drop
- Low leakage current
- High forward surge capability
- High frequency operation
- Meets MSL level 1, per J-STD-020, LF maximum peak of 245 °C (for TO-263AB package)
- Solder bath temperature 275 °C maximum, 10 s, per JESD 22-B106 (for TO-220AC and ITO-220AC package)
- AEC-Q101 qualified
- Material categorization: For definitions of compliance please see www.vishay.com/doc?99912

RoHS
COMPLIANT

TYPICAL APPLICATIONS

For use in low voltage, high frequency rectifier of switching mode power supplies, freewheeling diodes, DC/DC converters, and polarity protection application.

MECHANICAL DATA

Case: TO-220AC, ITO-220AC, TO-263AB

 Molding compound meets UL 94 V-0 flammability rating
 Base P/N-E3 - RoHS-compliant, commercial grade
 Base P/NHE3 - RoHS-compliant, AEC-Q101 qualified

Terminals: Matte tin plated leads, solderable per J-STD-002 and JESD 22-B102

E3 suffix meets JESD 201 class 1A whisker test, HE3 suffix meets JESD 201 class 2 whisker test

Polarity: As marked

Mounting Torque: 10 in-lbs maximum

PRIMARY CHARACTERISTICS

$I_{F(AV)}$	16 A
V_{RRM}	35 V to 60 V
I_{FSM}	150 A
V_F	0.56 V, 0.62 V
I_R	100 μ A
T_J max.	175 °C
Package	TO-220AC, ITO-220AC, TO-263AB
Diode variations	Single

MAXIMUM RATINGS ($T_C = 25$ °C unless otherwise noted)

PARAMETER	SYMBOL	MBR16H35	MBR16H45	MBR16H50	MBR16H60	UNIT
Maximum repetitive peak reverse voltage	V_{RRM}	35	45	50	60	V
Working peak reverse voltage	V_{RWM}	35	45	50	60	
Maximum DC blocking voltage	V_{DC}	35	45	50	60	
Maximum average forward rectified current (fig. 1)	$I_{F(AV)}$	16				A
Non-repetitive avalanche energy at 25 °C, $I_{AS} = 4$ A, $L = 10$ mH	E_{AS}	80				mJ
Peak forward surge current 8.3 ms single half sine-wave superimposed on rated load	I_{FSM}	150				A
Peak repetitive reverse surge current at $t_p = 2.0$ μ s, 1 kHz	I_{RRM}	1.0		0.5		
Peak non-repetitive reverse energy (8/20 μ s waveform)	E_{RSM}	20				mJ
Electrostatic discharge capacitor voltage Human body model: $C = 100$ pF, $R = 1.5$ k Ω	V_C	25				kV
Voltage rate of change (rated V_R)	dV/dt	10 000				V/ μ s
Operating junction and storage temperature range	T_J, T_{STG}	- 65 to + 175				°C
Isolation voltage (ITO-220AC only) from terminal to heatsink $t = 1$ min	V_{AC}	1500				V



ELECTRICAL CHARACTERISTICS (T _C = 25 °C unless otherwise noted)								
PARAMETER	SYMBOL	TEST CONDITIONS		MBR16H35 MBR16H45		MBR16H50 MBR16H60		UNIT
				TYP.	MAX.	TYP.	MAX.	
Maximum instantaneous forward voltage	V _F ⁽¹⁾	I _F = 16 A	T _J = 25 °C	-	0.66	-	0.73	V
		I _F = 16 A	T _J = 125 °C	0.52	0.56	0.58	0.62	
Maximum reverse current	I _R ⁽²⁾	Rated V _R	T _J = 25 °C	-	100	-	100	μA
			T _J = 125 °C	6.0	20	4.0	20	mA

Notes

⁽¹⁾ Pulse test: 300 μs pulse width, 1 % duty cycle

⁽²⁾ Pulse test: Pulse width ≤ 40 ms

THERMAL CHARACTERISTICS (T _A = 25 °C unless otherwise noted)						
PARAMETER	SYMBOL	MBR	MBRF	MBRB	UNIT	
Typical thermal resistance, junction to case	R _{θJC}	1.5	3.0	1.5	°C/W	

ORDERING INFORMATION (Example)					
PACKAGE	PREFERRED P/N	UNIT WEIGHT (g)	PACKAGE CODE	BASE QUANTITY	DELIVERY MODE
TO-220AC	MBR16H45-E3/45	1.80	45	50/tube	Tube
ITO-220AC	MBRF16H45-E3/45	1.94	45	50/tube	Tube
TO-263AB	MBRB16H45-E3/45	1.33	45	50/tube	Tube
TO-263AB	MBRB16H45-E3/81	1.33	81	800/reel	Tape and reel
TO-220AC	MBR16H45HE3/45 ⁽¹⁾	1.80	45	50/tube	Tube
ITO-220AC	MBRF16H45HE3/45 ⁽¹⁾	1.94	45	50/tube	Tube
TO-263AB	MBRB16H45HE3/45 ⁽¹⁾	1.33	45	50/tube	Tube
TO-263AB	MBRB16H45HE3/81 ⁽¹⁾	1.33	81	800/reel	Tape and reel

Note

⁽¹⁾ AEC-Q101 qualified

RATINGS AND CHARACTERISTICS CURVES

($T_A = 25\text{ }^\circ\text{C}$ unless otherwise noted)

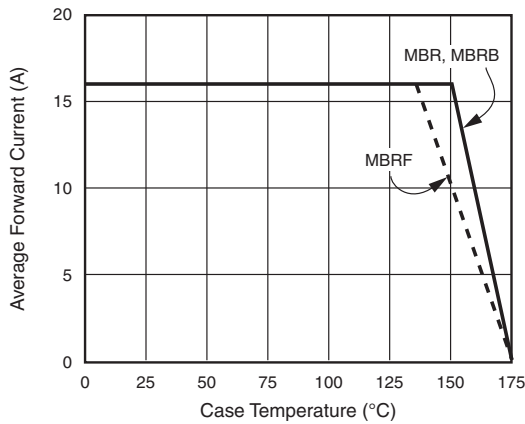

Fig. 1 - Forward Current Derating Curve

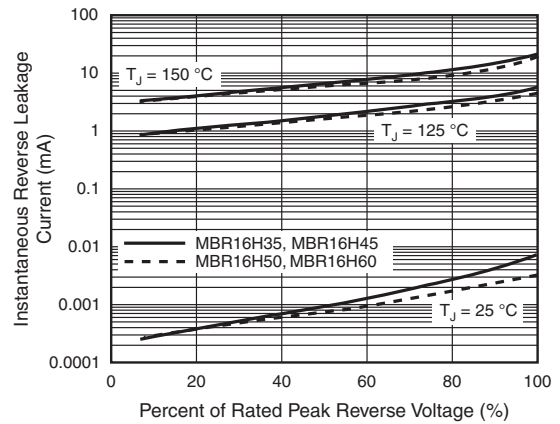

Fig. 4 - Typical Reverse Characteristics

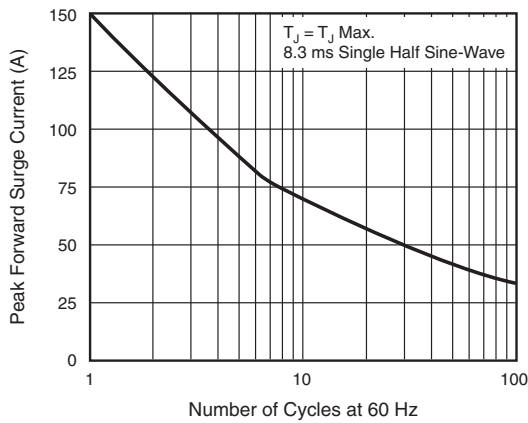

Fig. 2 - Maximum Non-Repetitive Peak Forward Surge Current

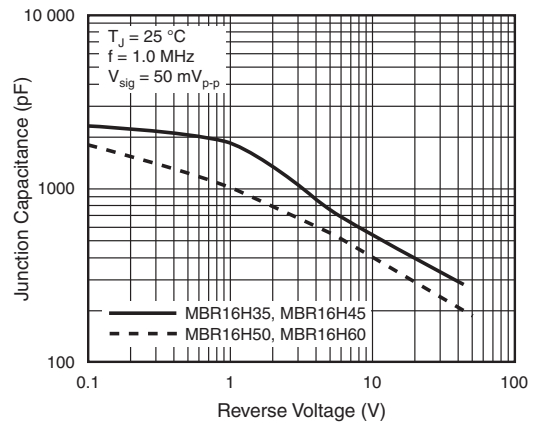

Fig. 5 - Typical Junction Capacitance

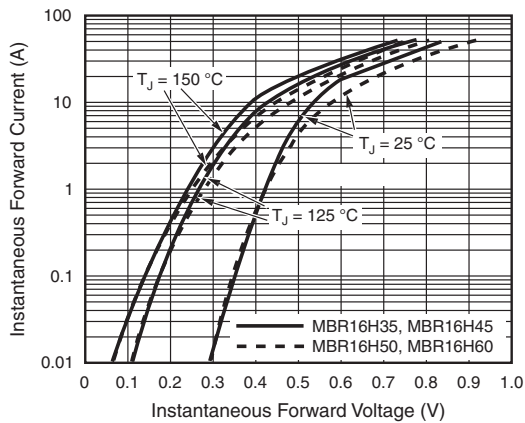

Fig. 3 - Typical Instantaneous Forward Characteristics

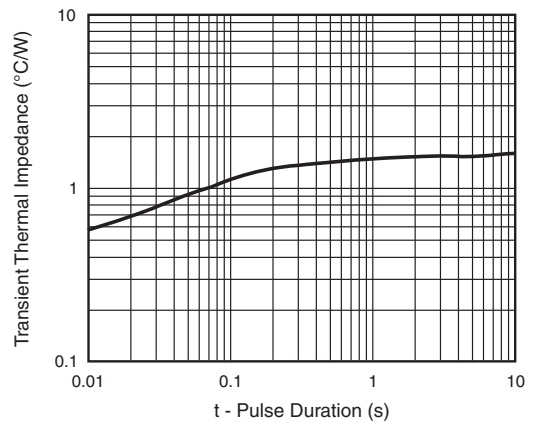
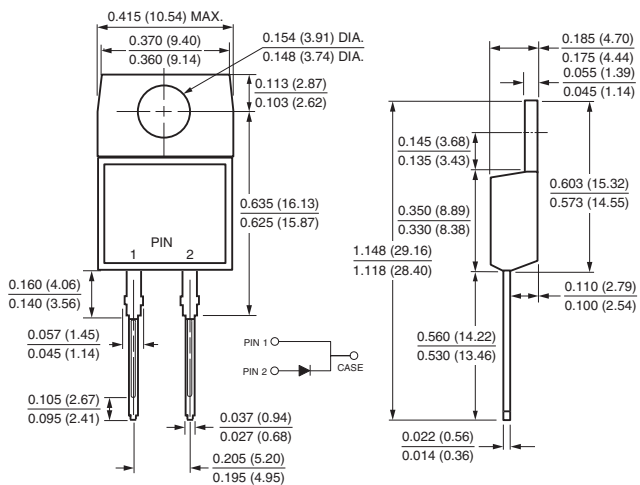

Fig. 6 - Typical Transient Thermal Impedance



PACKAGE OUTLINE DIMENSIONS in inches (millimeters)

TO-220AC



ITO-220AC

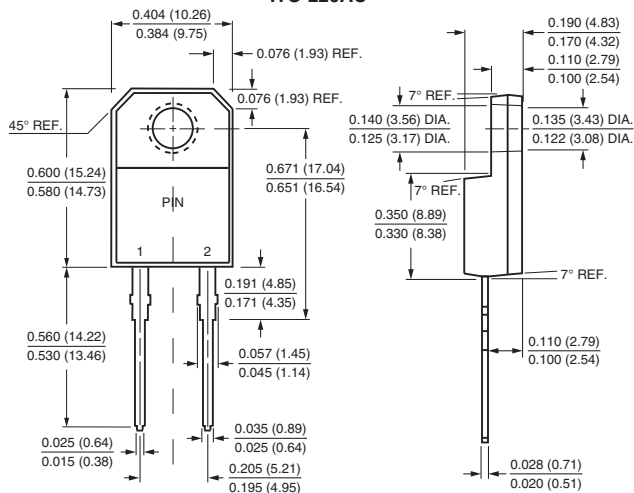

TO-263AB

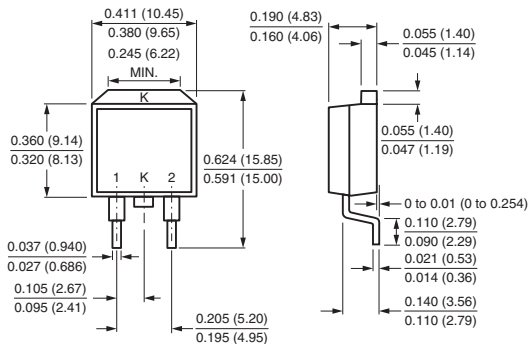

Mounting Pad Layout

