

13 12 11 10 9 8 7 6 3191 4 3 2 1

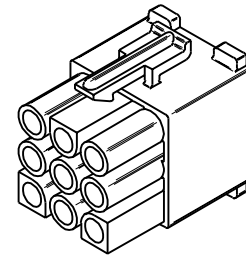
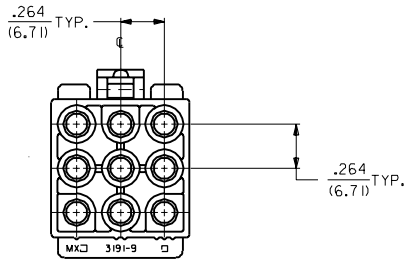
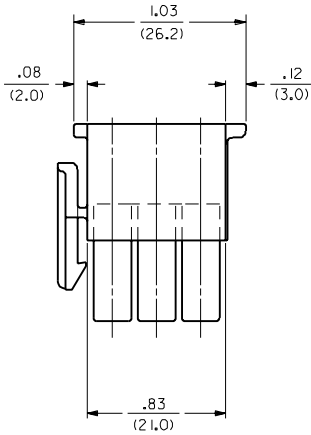
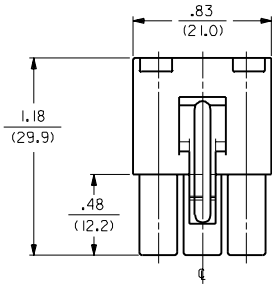
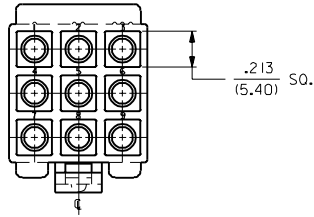

RECEPTACLE

DIMENSIONS SHOWN (METRIC) INCH		REVISIONS		REVISIONS		REVISIONS		REVISIONS		REVISIONS		REVISIONS		REVISIONS	
UNLESS OTHERWISE SPECIFIED TOLERANCES: ANGULAR ± .005 TO		J		SEE SHT. 1											
INCH		METRIC													
3 PLACE	± .010	---													
2 PLACE	± .014	± 0.25													
1 PLACE	---	± 0.35													
DRAFT WHERE APPLICABLE MUST REMAIN WITHIN DIMENSIONS		DRAWN BY: RAS		APP'D. BY: RAS		SCALE: 2 : 1		CHKD. BY: RW		DRWG. NO.: SD-3191-9		FILE NAME: 531919X2.DGN		DATE: 8/2/89	
MOLEX INCORPORATED		LITSEJLL		60532		U.S.A.		SHEET NO. 2		DATE 8/2/89		DIV. CP		SIZE	
SEE CHART		SD-3191-9													
THIS DRAWING CONTAINS INFORMATION THAT IS PROPRIETARY TO MOLEX INC. AND SHOULD NOT BE USED WITHOUT WRITTEN PERMISSION.												NO P.S. 1			

13 12 11 10 9 8 7 6 5 4 3 2 1

PLUG	
PART NO.	ENG. NO.
19-09-2098	3191-9P
19-09-2099	3191-9P1
19-09-2097	3191-9P-201
19-09-2096	3191-9P1-201

RECEPTACLE	
PART NO.	ENG. NO.
19-09-1099	3191-9R1
19-09-1096	3191-9R1-201

LEGEND:

3191-9****-*

CIRCUIT SIZE

P = PLUG

R = RECEPTACLE

EARS: BLANK = WITH PREBENT EARS (PLUG ONLY)

I = WITHOUT EARS

COLOR: BLANK = NATURAL COLOR

AM=AMBER BK=BLACK BU=BLUE
 BN=BROWN GY=GRAY GN=GREEN
 OR=ORANGE RD=RED YW=YELLOW
 COLORS AVAILABLE ONLY IN 94V-2 MATERIAL
 MATERIAL: BLANK=NYLON TYPE 6/6, 94V-2
 201=NYLON TYPE 6/6, 94V-0

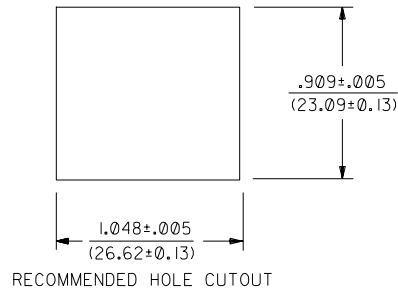
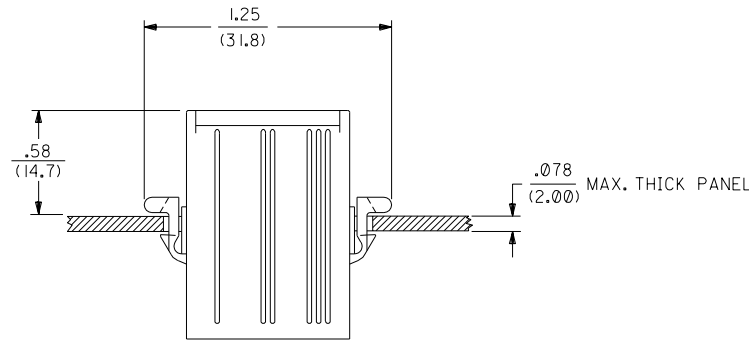

NOTES:

I. THESE HOUSINGS FOR USE WITH MOLEX .093/(2.36) DIAMETER SERIES TERMINALS.

DIMENSIONS SHOWN (METRIC) INCH	
UNLESS OTHERWISE SPECIFIED TOLERANCES: ANGULAR ± .04° 10	
5 PLACE ± .010	---
2 PLACE ± .014	± 0.25
1 PLACE ---	± 0.35
DRAFT WHERE APPLICABLE MUST REMAIN WITHIN DIMENSIONS	
DRWG. BY: GEP	CHK'D. BY: RW
APP'D. BY: RAS	SCALE: --:--

▽ =	▼ =	REVISE ONLY ON CAD SYSTEM
TITLE: .093/(2.36) HOUSINGS PLUG AND RECEPTACLE 9 CKT., .264/(6.70) CTRS.		
FROM: MOLEX INCORPORATED L15E,ILL. 60532 U.S.A.	SHEET NO. 3	DATE 8/2/89
PART NO. SEE CHART	DRWG. NO. SD-3191-9*	
FILE NAME: 531919X3.DWG	THIS DRAWING CONTAINS INFORMATION THAT IS PROPRIETARY TO MOLEX INC. AND SHOULD NOT BE USED WITHOUT WRITTEN PERMISSION.	
DRG. NO. CP	SIZE: C	NO P.S. 1

LTR.	REVISIONS	LTR.	REVISIONS
		J	SEE SHT. 1