

FDWS86068-F085

N-Channel POWERTRENCH® MOSFET

100 V, 80 A, 6.4 mΩ

Features

- Typ $R_{DS(on)}$ = 5.2 mΩ at $V_{GS} = 10$ V, $I_D = 80$ A
- Typ $Q_{g(tot)}$ = 31 nC at $V_{GS} = 10$ V, $I_D = 80$ A
- UIS Capability
- Qualified to AEC Q101
- Wettable flanks for automatic optical inspection (AOI)
- These Devices are Pb-Free and are RoHS Compliant

Applications

- Automotive Engine Control
- Powertrain Management
- Solenoid and Motor Drivers
- Electronic Steering

MOSFET MAXIMUM RATINGS ($T_A = 25^\circ\text{C}$, Unless otherwise specified)

Symbol	Parameter	Ratings	Unit
V_{DSS}	Drain to Source Voltage	100	V
V_{GS}	Gate to Source Voltage	±20	V
I_D	Drain Current ($T_C = 25^\circ\text{C}$) Continuous ($V_{GS} = 10$ V) (Note 1) Pulsed	80 (see Fig. 4)	A
E_{AS}	Single Pulse Avalanche Energy (Note 2)	36	mJ
P_D	Power Dissipation Derate above 25°C	214 1.43	W W/ $^\circ\text{C}$
T_J, T_{STG}	Operating and Storage Temperature	-55 to +150	$^\circ\text{C}$
$R_{\theta JC}$	Thermal Resistance (Junction to case)	0.7	$^\circ\text{C}/\text{W}$
$R_{\theta JA}$	Maximum Thermal Resistance (Junction to Ambient) (Note 3)	50	$^\circ\text{C}/\text{W}$

Stresses exceeding those listed in the Maximum Ratings table may damage the device. If any of these limits are exceeded, device functionality should not be assumed, damage may occur and reliability may be affected.



ON Semiconductor®

www.onsemi.com

V_{DSS}	I_D MAX	$R_{DS(on)}$ MAX
100 V	80 A	6.4 mΩ

ELECTRICAL CONNECTION

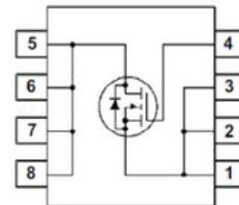

N-Channel MOSFET

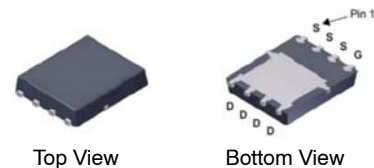

Power 56
(DFN8)
CASE 506DW

MARKING DIAGRAM

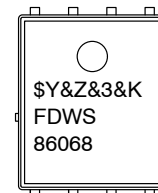

\$Y = ON Semiconductor Logo
 &Z = Assembly Plant Code
 &3 = Numeric Date Code
 &K = Lot Code
 FDWS86068 = Specific Device Code

ORDERING INFORMATION

See detailed ordering and shipping information on page 2 of this data sheet.

FDWS86068–F085

PACKAGE MARKING AND ORDERING INFORMATION

Device Marking	Device	Package	Reel Size	Tape Width	Quantity
FDWS86068	FDWS86068–F085	Power 56	13"	12 mm	3,000 Units

NOTES:

- Current is limited by wirebond configuration.
- Starting $T_J = 25^\circ\text{C}$, $L = 20\ \mu\text{H}$, $I_{AS} = 60\ \text{A}$, $V_{DD} = 80\ \text{V}$ during inductor charging and $V_{DD} = 0\ \text{V}$ during time in avalanche.
- $R_{\theta JA}$ is the sum of the junction-to-case and case-to-ambient thermal resistance where the case thermal reference is defined as the solder mounting surface of the drain pins. $R_{\theta JC}$ is guaranteed by design while $R_{\theta JA}$ is determined by the user's board design. The maximum rating presented here is based on mounting on a 1 in2 pad of 2oz copper.

ELECTRICAL CHARACTERISTICS ($T_J = 25^\circ\text{C}$ unless otherwise noted)

Symbol	Parameter	Test Conditions	Min	Typ	Max	Unit
--------	-----------	-----------------	-----	-----	-----	------

OFF CHARACTERISTICS

B_{VDSS}	Drain to Source Breakdown Voltage	$I_D = 250\ \mu\text{A}$, $V_{GS} = 0\ \text{V}$	100	–	–	V
I_{DSS}	Drain to Source Leakage Current	$V_{DS} = 100\ \text{V}$, $V_{GS} = 0\ \text{V}$ ($T_J = 25^\circ\text{C}$) ($T_J = 175^\circ\text{C}$) (Note 4)	–	–	1	μA mA
I_{GSS}	Gate to Source Leakage Current	$V_{GS} = \pm 20\ \text{V}$	–	–	± 100	nA

ON CHARACTERISTICS

$V_{GS(th)}$	Gate to Source Threshold Voltage	$V_{GS} = V_{DS}$, $I_D = 250\ \mu\text{A}$	2	3	4	V
$R_{DS(on)}$	Drain to Source On Resistance	$V_{GS} = 10\ \text{V}$, $I_D = 80\ \text{A}$ ($T_J = 25^\circ\text{C}$) ($T_J = 175^\circ\text{C}$) (Note 4)	–	5.2 11.4	6.4 14	$\text{m}\Omega$

DYNAMIC CHARACTERISTICS

C_{iss}	Input Capacitance	$V_{DS} = 50\ \text{V}$, $V_{GS} = 0\ \text{V}$, $f = 1\ \text{MHz}$	–	2220	–	pF
C_{oss}	Output Capacitance		–	1350	–	pF
C_{rss}	Reverse Transfer Capacitance		–	19	–	pF
R_g	Gate Resistance	$V_{GS} = 0.5\ \text{V}$, $f = 1\ \text{MHz}$	–	0.3	–	Ω
$Q_{g(tot)}$	Total Gate Charge	$V_{GS} = 0$ to $10\ \text{V}$, $V_{DD} = 50\ \text{V}$, $I_D = 80\ \text{A}$	–	31	43	nC
$Q_{g(th)}$	Threshold Gate Charge	$V_{GS} = 0$ to $2\ \text{V}$, $V_{DD} = 50\ \text{V}$, $I_D = 80\ \text{A}$	–	4	–	nC
Q_{gs}	Gate to Source Gate Charge	$V_{DD} = 50\ \text{V}$, $I_D = 80\ \text{A}$	–	12	–	nC
Q_{gd}	Gate to Drain "Miller" Charge		–	7	–	nC

SWITCHING CHARACTERISTICS

t_{on}	Turn-On Time	$V_{DD} = 50\ \text{V}$, $I_D = 80\ \text{A}$, $V_{GS} = 10\ \text{V}$, $R_{GEN} = 6\ \Omega$	–	–	30	ns
$t_{d(on)}$	Turn-On Delay Time		–	15	–	ns
t_r	Turn-On Rise Time		–	6	–	ns
$t_{d(off)}$	Turn-Off Delay Time		–	24	–	ns
t_f	Turn-Off Fall Time		–	7	–	ns
t_{off}	Turn-Off Time		–	–	48	ns

DRAIN-SOURCE DIODE CHARACTERISTICS

V_{SD}	Source to Drain Diode Forward Voltage	$I_{SD} = 80\ \text{A}$, $V_{GS} = 0\ \text{V}$	–	0.95	1.3	V
		$I_{SD} = 40\ \text{A}$, $V_{GS} = 0\ \text{V}$	–	0.87	1.2	V
T_{rr}	Reverse Recovery Time	$I_F = 80\ \text{A}$, $dI_{SD}/dt = 100\ \text{A}/\mu\text{s}$	–	61	80	ns
Q_{rr}	Reverse Recovery Charge		–	56	84	nC

Product parametric performance is indicated in the Electrical Characteristics for the listed test conditions, unless otherwise noted. Product performance may not be indicated by the Electrical Characteristics if operated under different conditions.

- The maximum value is specified by design at $T_J = 175^\circ\text{C}$. Product is not tested to this condition in production

TYPICAL CHARACTERISTICS

($T_J = 25^\circ\text{C}$ unless otherwise noted)

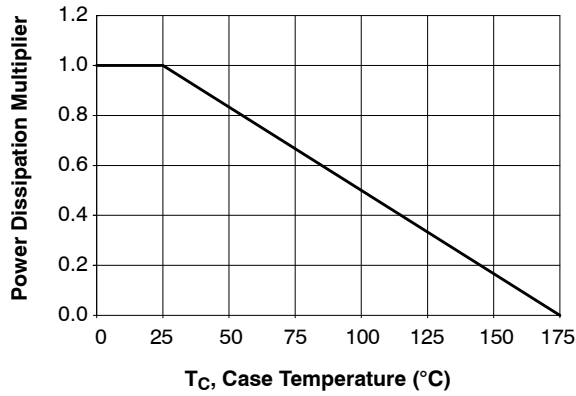

Figure 1. Normalized Power Dissipation vs. Case Temperature

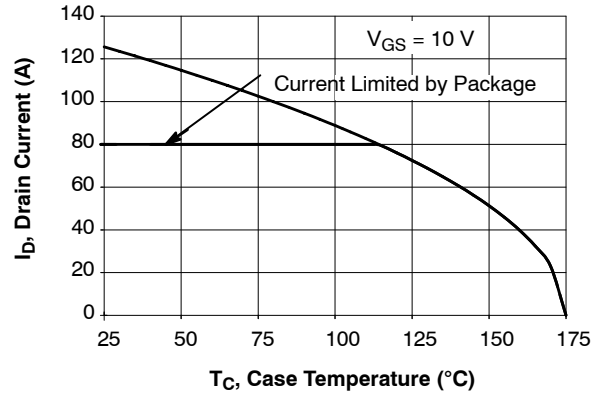

Figure 2. Maximum Continuous Drain Current vs. Case Temperature

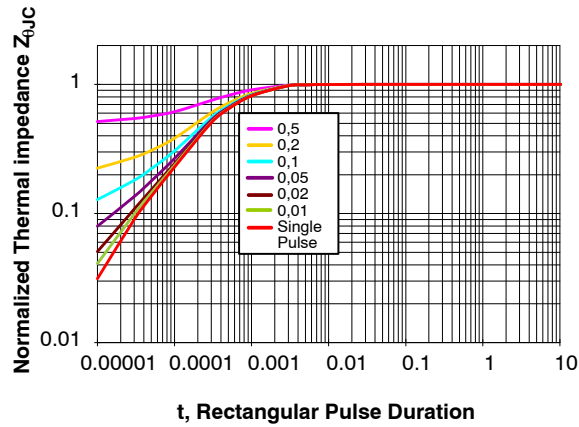

Figure 3. Normalized Maximum Transient Thermal Impedance

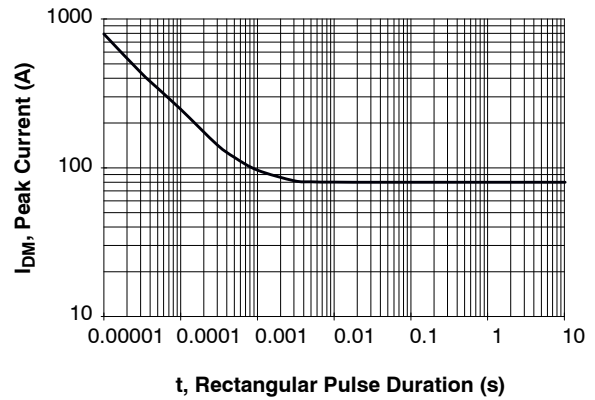

Figure 4. Peak Current Capability

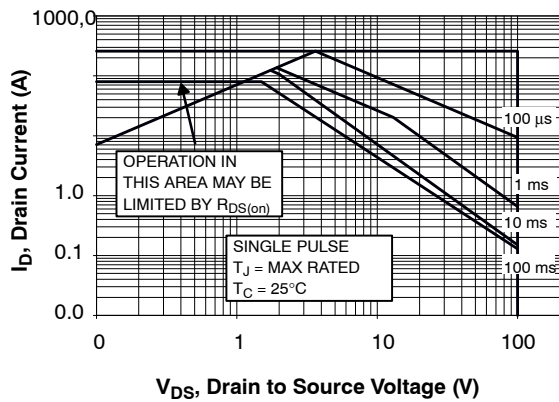

Figure 5. Forward Bias Safe Operating Area

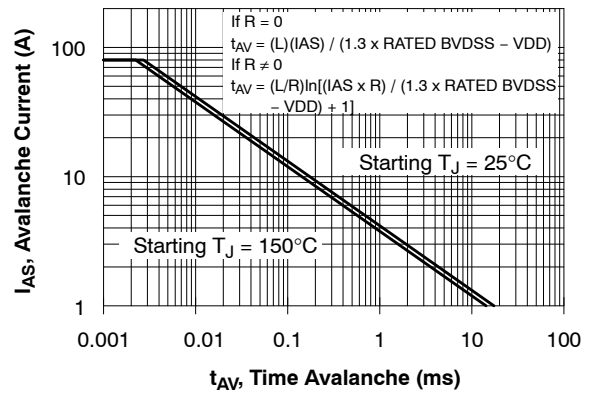

Figure 6. Unclamped Inductive Switching Capability

NOTE: Refer to On Semiconductor Application Notes AN7514 and AN7515

TYPICAL CHARACTERISTICS

($T_J = 25^\circ\text{C}$ unless otherwise noted)

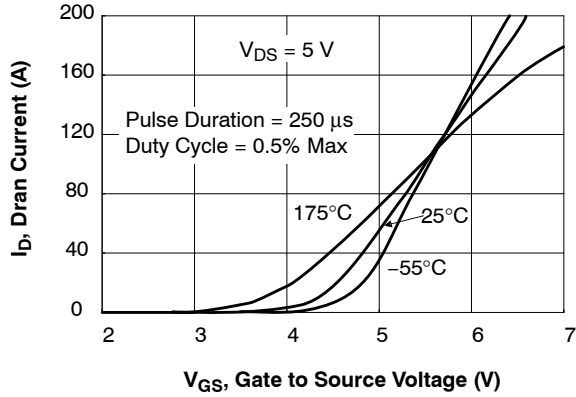

Figure 7. Transfer Characteristic

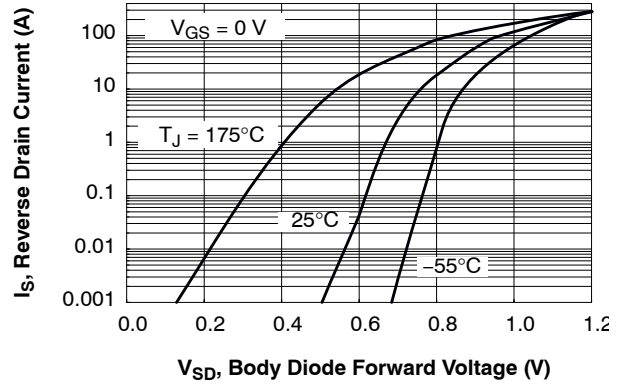

Figure 8. Forward Diode Characteristics

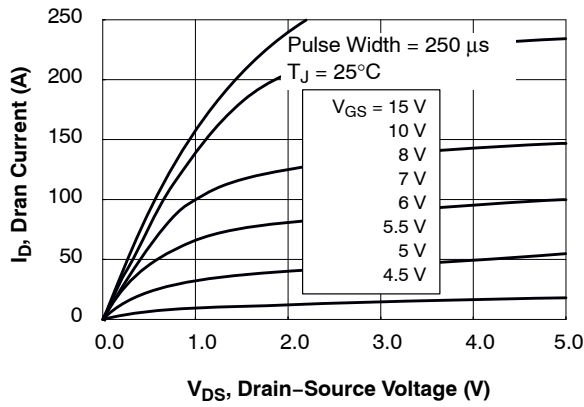

Figure 9.

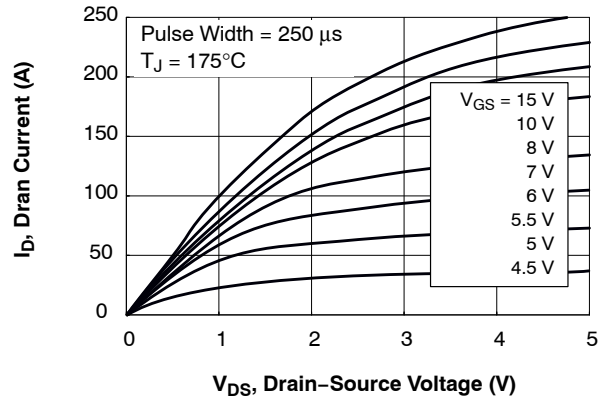

Figure 10. Peak Current Capability

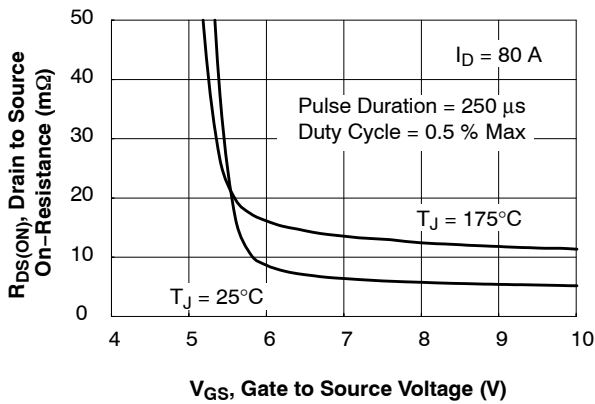

Figure 11. $R_{DS(on)}$ vs. Gate Voltage

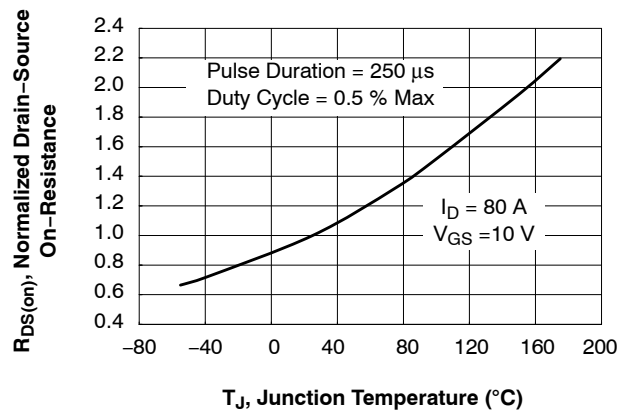

Figure 12. Normalized $R_{DS(on)}$ vs. Junction Temperature

TYPICAL CHARACTERISTICS

($T_J = 25^\circ\text{C}$ unless otherwise noted)

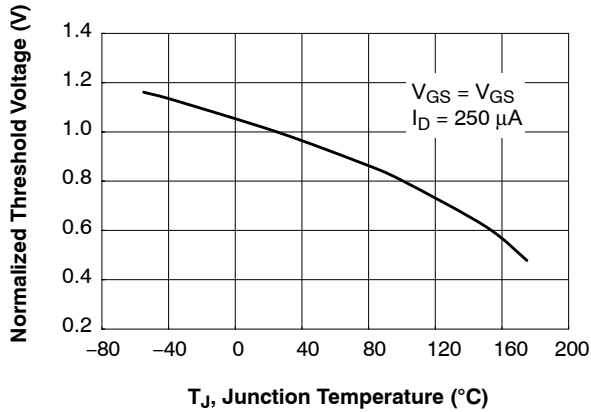

Figure 13. Normalized Gate Threshold Voltage vs. Temperature

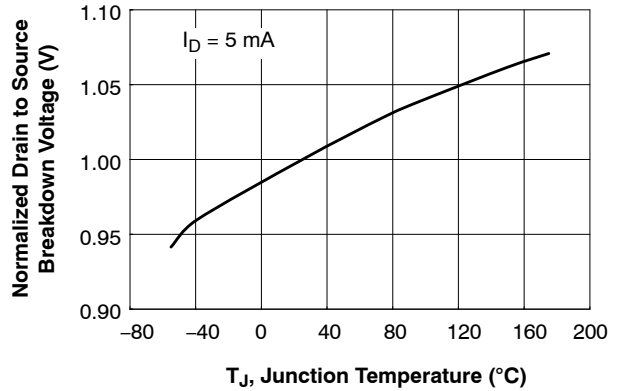

Figure 14. Normalized Drain to Source Breakdown Voltage vs. Junction Temperature

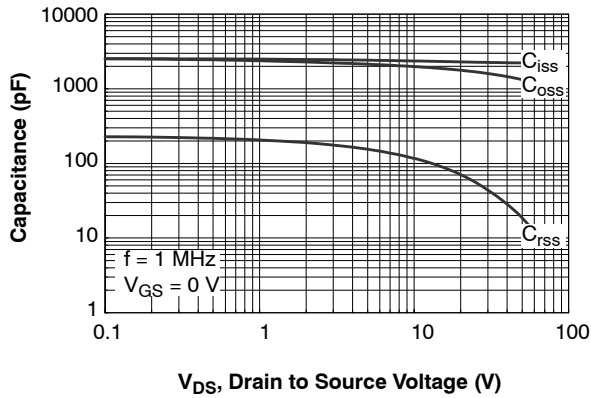

Figure 15. Capacitance vs. Drain to Source Voltage

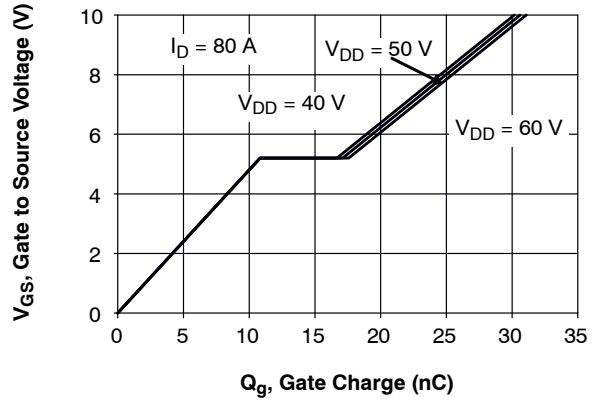

Figure 16. Gate Charge vs. Gate to Source Voltage

MECHANICAL CASE OUTLINE
PACKAGE DIMENSIONS

ON Semiconductor®



DFN8 5.1x6.3, 1.27P
CASE 506DW
ISSUE O

DATE 28 FEB 2017

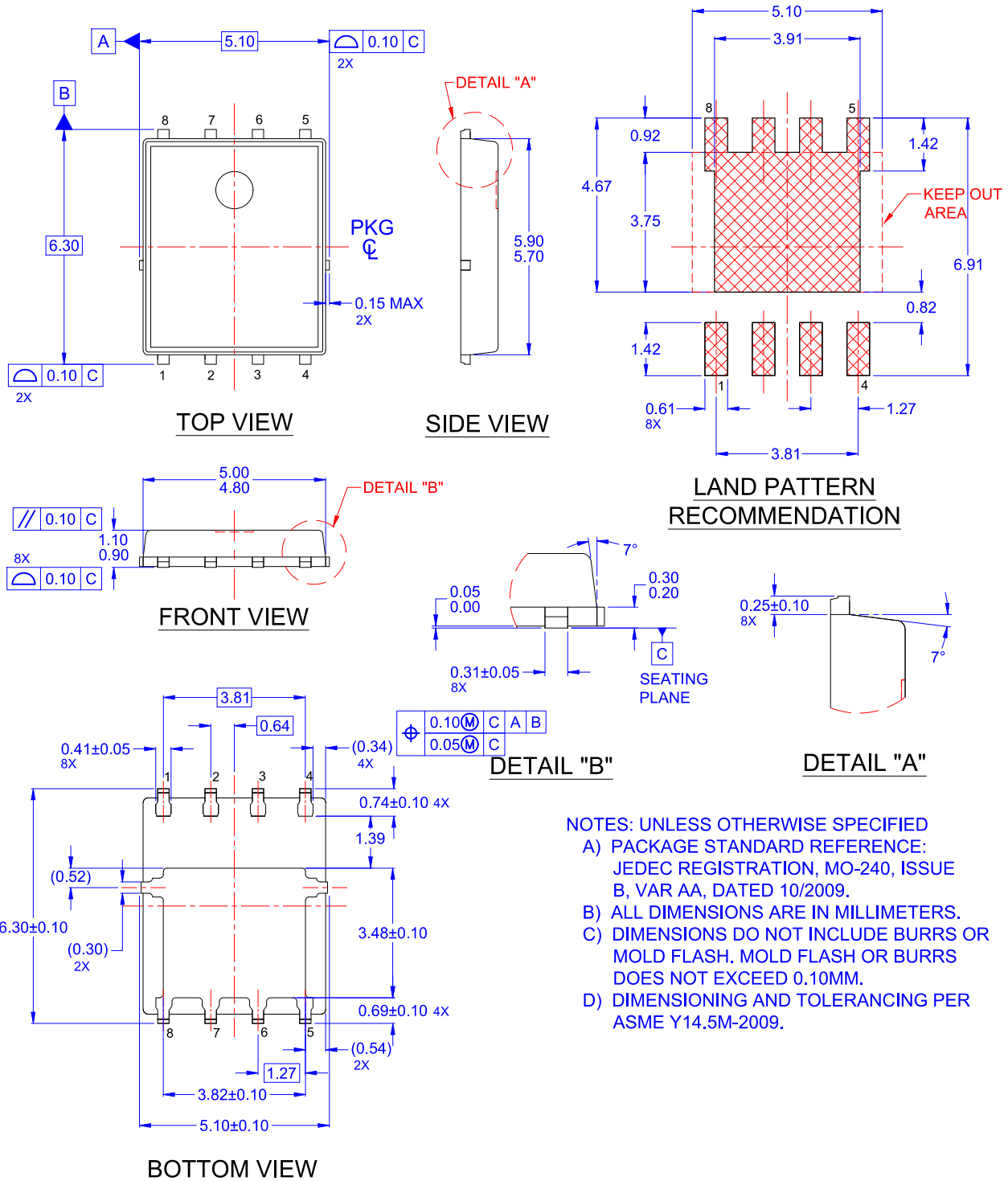

- NOTES:** UNLESS OTHERWISE SPECIFIED
- A) PACKAGE STANDARD REFERENCE: JEDEC REGISTRATION, MO-240, ISSUE B, VAR AA, DATED 10/2009.
 - B) ALL DIMENSIONS ARE IN MILLIMETERS.
 - C) DIMENSIONS DO NOT INCLUDE BURRS OR MOLD FLASH. MOLD FLASH OR BURRS DOES NOT EXCEED 0.10MM.
 - D) DIMENSIONING AND TOLERANCING PER ASME Y14.5M-2009.

DOCUMENT NUMBER:	98AON13746G	Electronic versions are uncontrolled except when accessed directly from the Document Repository. Printed versions are uncontrolled except when stamped "CONTROLLED COPY" in red.
STATUS:	ON SEMICONDUCTOR STANDARD	
NEW STANDARD:		
DESCRIPTION:	DFN8 5.1x6.3, 1.27P	PAGE 1 OF 2

ON Semiconductor and  are trademarks of Semiconductor Components Industries, LLC dba ON Semiconductor or its subsidiaries in the United States and/or other countries. ON Semiconductor owns the rights to a number of patents, trademarks, copyrights, trade secrets, and other intellectual property. A listing of ON Semiconductor's product/patent coverage may be accessed at www.onsemi.com/site/pdf/Patent-Marking.pdf. ON Semiconductor reserves the right to make changes without further notice to any products herein. ON Semiconductor makes no warranty, representation or guarantee regarding the suitability of its products for any particular purpose, nor does ON Semiconductor assume any liability arising out of the application or use of any product or circuit, and specifically disclaims any and all liability, including without limitation special, consequential or incidental damages. Buyer is responsible for its products and applications using ON Semiconductor products, including compliance with all laws, regulations and safety requirements or standards, regardless of any support or applications information provided by ON Semiconductor. "Typical" parameters which may be provided in ON Semiconductor data sheets and/or specifications can and do vary in different applications and actual performance may vary over time. All operating parameters, including "Typicals" must be validated for each customer application by customer's technical experts. ON Semiconductor does not convey any license under its patent rights nor the rights of others. ON Semiconductor products are not designed, intended, or authorized for use as a critical component in life support systems or any FDA Class 3 medical devices or medical devices with a same or similar classification in a foreign jurisdiction or any devices intended for implantation in the human body. Should Buyer purchase or use ON Semiconductor products for any such unintended or unauthorized application, Buyer shall indemnify and hold ON Semiconductor and its officers, employees, subsidiaries, affiliates, and distributors harmless against all claims, costs, damages, and expenses, and reasonable attorney fees arising out of, directly or indirectly, any claim of personal injury or death associated with such unintended or unauthorized use, even if such claim alleges that ON Semiconductor was negligent regarding the design or manufacture of the part. ON Semiconductor is an Equal Opportunity/Affirmative Action Employer. This literature is subject to all applicable copyright laws and is not for resale in any manner.

PUBLICATION ORDERING INFORMATION

LITERATURE FULFILLMENT:

Literature Distribution Center for ON Semiconductor
19521 E. 32nd Pkwy, Aurora, Colorado 80011 USA
Phone: 303-675-2175 or 800-344-3860 Toll Free USA/Canada
Fax: 303-675-2176 or 800-344-3867 Toll Free USA/Canada
Email: orderlit@onsemi.com

N. American Technical Support: 800-282-9855 Toll Free
USA/Canada
Europe, Middle East and Africa Technical Support:
Phone: 421 33 790 2910

ON Semiconductor Website: www.onsemi.com

Order Literature: <http://www.onsemi.com/orderlit>

For additional information, please contact your local
Sales Representative