



Is Now Part of



ON Semiconductor®

To learn more about ON Semiconductor, please visit our website at
www.onsemi.com

ON Semiconductor and the ON Semiconductor logo are trademarks of Semiconductor Components Industries, LLC dba ON Semiconductor or its subsidiaries in the United States and/or other countries. ON Semiconductor owns the rights to a number of patents, trademarks, copyrights, trade secrets, and other intellectual property. A listing of ON Semiconductor's product/patent coverage may be accessed at www.onsemi.com/site/pdf/Patent-Marking.pdf. ON Semiconductor reserves the right to make changes without further notice to any products herein. ON Semiconductor makes no warranty, representation or guarantee regarding the suitability of its products for any particular purpose, nor does ON Semiconductor assume any liability arising out of the application or use of any product or circuit, and specifically disclaims any and all liability, including without limitation special, consequential or incidental damages. Buyer is responsible for its products and applications using ON Semiconductor products, including compliance with all laws, regulations and safety requirements or standards, regardless of any support or applications information provided by ON Semiconductor. "Typical" parameters which may be provided in ON Semiconductor data sheets and/or specifications can and do vary in different applications and actual performance may vary over time. All operating parameters, including "Typicals" must be validated for each customer application by customer's technical experts. ON Semiconductor does not convey any license under its patent rights nor the rights of others. ON Semiconductor products are not designed, intended, or authorized for use as a critical component in life support systems or any FDA Class 3 medical devices or medical devices with a same or similar classification in a foreign jurisdiction or any devices intended for implantation in the human body. Should Buyer purchase or use ON Semiconductor products for any such unintended or unauthorized application, Buyer shall indemnify and hold ON Semiconductor and its officers, employees, subsidiaries, affiliates, and distributors harmless against all claims, costs, damages, and expenses, and reasonable attorney fees arising out of, directly or indirectly, any claim of personal injury or death associated with such unintended or unauthorized use, even if such claim alleges that ON Semiconductor was negligent regarding the design or manufacture of the part. ON Semiconductor is an Equal Opportunity/Affirmative Action Employer. This literature is subject to all applicable copyright laws and is not for resale in any manner.

PACKAGE DIMENSIONS

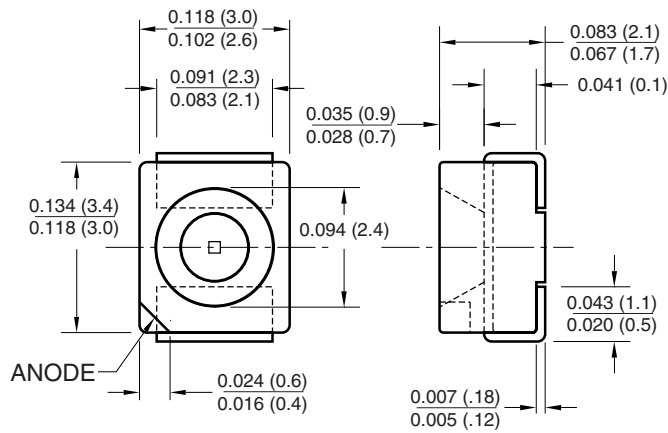

NOTES:

1. Dimensions are in inches (mm)
2. Tolerance of $\pm .010$ (.25) on all non nominal dimensions unless otherwise specified.

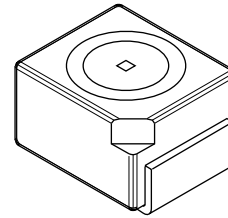

FEATURES

- Wavelength = 880 nm, AlGaAs
- Wide Emission Angle, 120°
- Surface Mount PLCC-2 Package
- High Power

SCHEMATIC

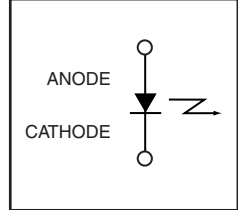

ABSOLUTE MAXIMUM RATINGS ($T_A = 25^\circ\text{C}$ unless otherwise specified)

Parameter	Symbol	Rating	Unit
Operating Temperature	T_{opr}	-55 to +100	$^\circ\text{C}$
Storage Temperature	T_{stg}	-55 to +100	$^\circ\text{C}$
Soldering Temperature (Flow) ^(2,3)	T_{sol}	260 for 10 sec	$^\circ\text{C}$
Continuous Forward Current	I_F	100	mA
Reverse Voltage	V_R	5	V
Peak Forward Current ⁽⁴⁾	I_{FM}	1.75	A
Power Dissipation ⁽¹⁾	P_D	180	mW

NOTES

1. Derate power dissipation linearly 2.4 mW/ $^\circ\text{C}$ above 25 $^\circ\text{C}$.
2. RMA flux is recommended.
3. Methanol or isopropyl alcohols are recommended as cleaning agents.
4. Pulse conditions; $t_p = 100 \mu\text{s}$, $T = 10 \text{ ms}$.

ELECTRICAL / OPTICAL CHARACTERISTICS ($T_A = 25^\circ\text{C}$)

PARAMETER	TEST CONDITIONS	SYMBOL	MIN.	TYP.	MAX.	UNITS
Peak Emission Wavelength	$I_F = 100 \text{ mA}$	λ_P	—	880	—	nm
Spectral Bandwidth	$I_F = 100 \text{ mA}$	$\Delta\lambda$	—	80	—	nm
Emission Angle	$I_F = 100 \text{ mA}$	θ	—	120	—	Deg.
Forward Voltage	$I_F = 100 \text{ mA}$, $t_p = 20 \text{ ms}$	V_F	—	1.5	1.8	V
	$I_F = 1 \text{ A}$, $t_p = 100 \mu\text{s}$		—	3.0	3.8	
Reverse Current	$V_R = 5 \text{ V}$	I_R	—	—	1	μA
Radiant Intensity	$I_F = 100 \text{ mA}$, $t_p = 20 \text{ ms}$	I_e	4	—	8	mW/sr
	$I_F = 1 \text{ A}$, $t_p = 100 \mu\text{s}$		—	48	—	
Radiant Flux	$I_F = 100 \text{ mA}$, $t_p = 20 \text{ ms}$	ϕ_e	—	10	—	mW
Temp. Coeff. of I_E	$I_F = 100 \text{ mA}$	T_{CI}	—	-0.5	—	%/K
Temp. Coeff. of V_F	$I_F = 100 \text{ mA}$	T_{CV}	—	-4	—	mV/K
Temp. Coeff. of λ	$I_F = 100 \text{ mA}$	$T_{C\lambda}$	—	0.25	—	nm/K
Rise Time	$I_F = 100 \text{ mA}$	t_r	—	—	1	μs
Fall Time	$I_F = 100 \text{ mA}$	t_f	—	—	1	μs

TYPICAL PERFORMANCE CURVES

Fig. 1 Normalized Radiant Intensity vs. Forward Current

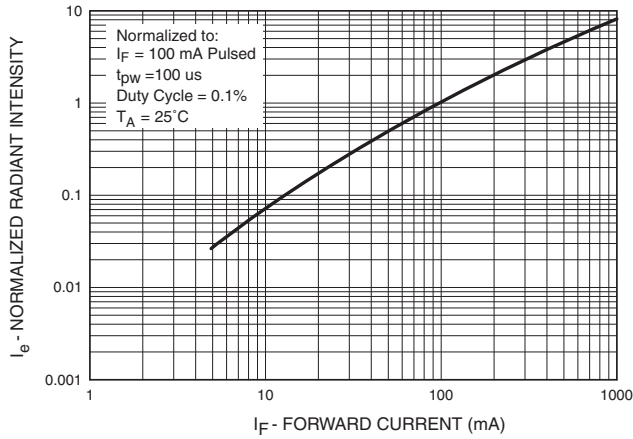

Fig. 2 Forward Current vs. Forward Voltage

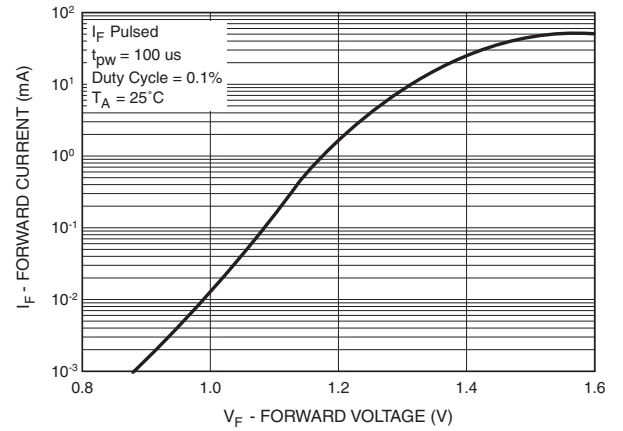

Fig. 4 Forward Voltage vs. Ambient Temperature

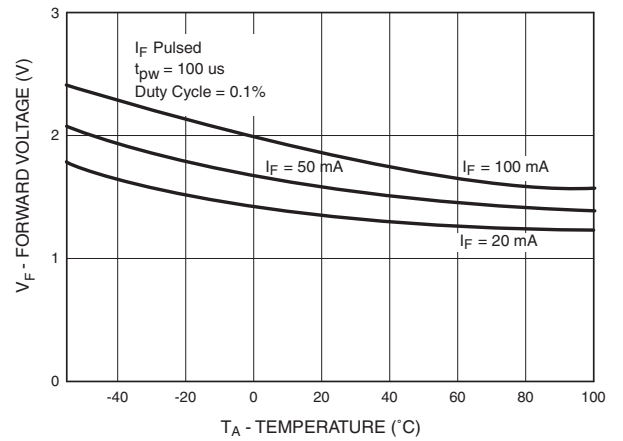

Fig.3 Radiation Diagram

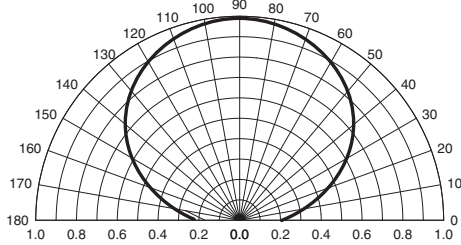

Fig. 5 Spectral Response (TBD)

DISCLAIMER

FAIRCHILD SEMICONDUCTOR RESERVES THE RIGHT TO MAKE CHANGES WITHOUT FURTHER NOTICE TO ANY PRODUCTS HEREIN TO IMPROVE RELIABILITY, FUNCTION OR DESIGN. FAIRCHILD DOES NOT ASSUME ANY LIABILITY ARISING OUT OF THE APPLICATION OR USE OF ANY PRODUCT OR CIRCUIT DESCRIBED HEREIN; NEITHER DOES IT CONVEY ANY LICENSE UNDER ITS PATENT RIGHTS, NOR THE RIGHTS OF OTHERS.

LIFE SUPPORT POLICY

FAIRCHILD'S PRODUCTS ARE NOT AUTHORIZED FOR USE AS CRITICAL COMPONENTS IN LIFE SUPPORT DEVICES OR SYSTEMS WITHOUT THE EXPRESS WRITTEN APPROVAL OF THE PRESIDENT OF FAIRCHILD SEMICONDUCTOR CORPORATION. As used herein:

1. Life support devices or systems are devices or systems which, (a) are intended for surgical implant into the body, or (b) support or sustain life, and (c) whose failure to perform when properly used in accordance with instructions for use provided in labeling, can be reasonably expected to result in a significant injury of the user.
2. A critical component in any component of a life support device or system whose failure to perform can be reasonably expected to cause the failure of the life support device or system, or to affect its safety or effectiveness.

ON Semiconductor and  are trademarks of Semiconductor Components Industries, LLC dba ON Semiconductor or its subsidiaries in the United States and/or other countries. ON Semiconductor owns the rights to a number of patents, trademarks, copyrights, trade secrets, and other intellectual property. A listing of ON Semiconductor's product/patent coverage may be accessed at www.onsemi.com/site/pdf/Patent-Marking.pdf. ON Semiconductor reserves the right to make changes without further notice to any products herein. ON Semiconductor makes no warranty, representation or guarantee regarding the suitability of its products for any particular purpose, nor does ON Semiconductor assume any liability arising out of the application or use of any product or circuit, and specifically disclaims any and all liability, including without limitation special, consequential or incidental damages. Buyer is responsible for its products and applications using ON Semiconductor products, including compliance with all laws, regulations and safety requirements or standards, regardless of any support or applications information provided by ON Semiconductor. "Typical" parameters which may be provided in ON Semiconductor data sheets and/or specifications can and do vary in different applications and actual performance may vary over time. All operating parameters, including "Typicals" must be validated for each customer application by customer's technical experts. ON Semiconductor does not convey any license under its patent rights nor the rights of others. ON Semiconductor products are not designed, intended, or authorized for use as a critical component in life support systems or any FDA Class 3 medical devices or medical devices with a same or similar classification in a foreign jurisdiction or any devices intended for implantation in the human body. Should Buyer purchase or use ON Semiconductor products for any such unintended or unauthorized application, Buyer shall indemnify and hold ON Semiconductor and its officers, employees, subsidiaries, affiliates, and distributors harmless against all claims, costs, damages, and expenses, and reasonable attorney fees arising out of, directly or indirectly, any claim of personal injury or death associated with such unintended or unauthorized use, even if such claim alleges that ON Semiconductor was negligent regarding the design or manufacture of the part. ON Semiconductor is an Equal Opportunity/Affirmative Action Employer. This literature is subject to all applicable copyright laws and is not for resale in any manner.

PUBLICATION ORDERING INFORMATION

LITERATURE FULFILLMENT:

Literature Distribution Center for ON Semiconductor
19521 E. 32nd Pkwy, Aurora, Colorado 80011 USA
Phone: 303-675-2175 or 800-344-3860 Toll Free USA/Canada
Fax: 303-675-2176 or 800-344-3867 Toll Free USA/Canada
Email: orderlit@onsemi.com

N. American Technical Support: 800-282-9855 Toll Free
USA/Canada
Europe, Middle East and Africa Technical Support:
Phone: 421 33 790 2910
Japan Customer Focus Center
Phone: 81-3-5817-1050

ON Semiconductor Website: www.onsemi.com
Order Literature: <http://www.onsemi.com/orderlit>
For additional information, please contact your local
Sales Representative