

QT-Brightek PLCC Series

PLCC2 LED

Part No.: QBLP671 Series

Product: QBLP671_series	Date: November 21, 2017	Page 1 of 12
	Version# 1.4	

Table of Contents:

Introduction	3
Electrical / Optical Characteristic (Ta=25 °C)	4
Absolute Maximum Rating	4
Characteristic Curves.....	7
Solder Profile & Footprint.....	9
Packing	10
Labeling	11
Ordering Information	11
Revision History	12
Disclaimer	12

Introduction

Feature:

- Package in tape and reel
- Ultra bright reflector type PLCC2 LED
- InGaN technology for IB/IG
- AlInGaP technology for R/O /S
- 120 degree viewing angle
- ESD protection for InGaN IB and IG

Description:

These ultra bright reflector type PLCC2 LEDs have a height profile of 1.95mm. Combination of high brightness output and robust package, these LEDs are ideal for architecture lighting, status indication, and industrial equipment lighting applications.

Application:

- Status indication
- Industrial equipment backlighting
- Architecture lighting

Certification & Compliance:

- TS16949
- ISO9001
- RoHS Compliant



Dimension:

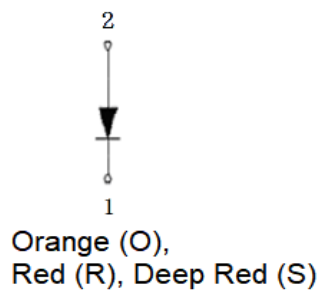
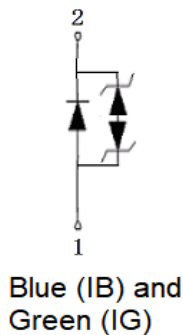
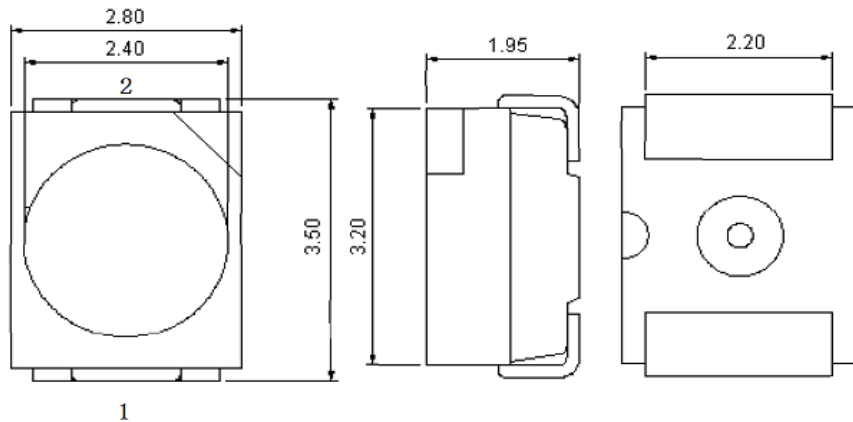

Units: mm / tolerance = +/-0.2mm

Electrical / Optical Characteristic (Ta=25 °C)

Product	Color	I _F (mA)	V _F (V)		λ _D (nm)			I _V (mcd)	
			Typ.	Max.	Min.	Typ.	Max.	Min.	Typ.
QBLP671E-IB	Blue	20	3.1	3.6	460	465	470	220	300
QBLP671E-IG	True Green	20	3.1	3.6	515	525	535	830	1500
QBLP671-R	Red	20	2.0	2.7	620	625	630	830	900
QBLP671-O	Orange	20	2.0	2.7	600	605	615	490	900
QBLP671-S	Deep Red	20	2.0	2.7	630	640	650	130	200

Absolute Maximum Rating

Material	P _d (mW)	I _F (mA)	I _{FP} (mA)*	V _R (V)	T _{OP} (°C)	T _{ST} (°C)	T _{SO L} (°C)**
InGaN (IB/IG)	120	30	100	5	-40 ~ +105	-40 ~ +105	260
AllnGaP (R/O/S)	75	30	125	5	-40 ~ +105	-40 ~ +105	260

*Duty 1/8 @ 1KHz

**IR Reflow for no more than 10 sec @ 260 °C

Note: Drive current at 5mA is recommended for long term light output maintenance and minimal degradation.

Forward Voltage V_F for InGaN @ I_F=20mA

Bin	Min.	Max.	Unit
V2B	2.4	2.7	V
V2C	2.7	3.0	
V3A	3.0	3.3	
V3B	3.3	3.6	

Forward Voltage V_F for AllnGaP @ I_F=20mA

Bin	Min.	Max.	Unit
V1C	1.8	2.1	V
V2A	2.1	2.4	
V2B	2.4	2.7	

Luminous Intensity I_V for AlInGaP (R/O/S) @ $I_F=20mA$

Bin	Min.	Max.	Unit
20	130	170	mcd
21	170	220	
22	220	290	
23	290	370	
24	370	490	
25	490	640	
26	640	830	
27	830	1080	
28	1080	1400	
29	1400	1800	
30	1800	2300	

Luminous Intensity I_V for InGaN (IG/IB) @ $I_F=20mA$

Bin	Min.	Max.	Unit
22	220	290	mcd
23	290	380	
24	380	490	
25	490	640	
26	640	830	
27	830	1080	
28	1080	1400	
29	1400	1800	
30	1800	2300	

Dominant Wavelength λ_D for Blue @ $I_F=20mA$

Bin	Min.	Max.	Unit
B5	460	465	nm
B6	465	470	

Dominant Wavelength λ_D for True Green @ $I_F=20mA$

Bin	Min.	Max.	Unit
TG1	515	520	nm
TG2	520	525	
TG3	525	530	
TG4	530	535	

Dominant Wavelength λ_D for Orange @ $I_F=20mA$

Bin	Min.	Max.	Unit
A2	600	605	nm
A3	605	610	
A4	610	615	

Dominant Wavelength λ_D for Red @ $I_F=20mA$

Bin	Min.	Max.	Unit
R1	620	625	nm
R2	625	630	

Dominant Wavelength λ_D for Deep Red @ $I_F=20mA$

Bin	Min.	Max.	Unit
R3	630	640	nm
R4	640	650	

Characteristic Curves

AllnGaP (R/O/S)

Forward Current VS. Forward Voltage

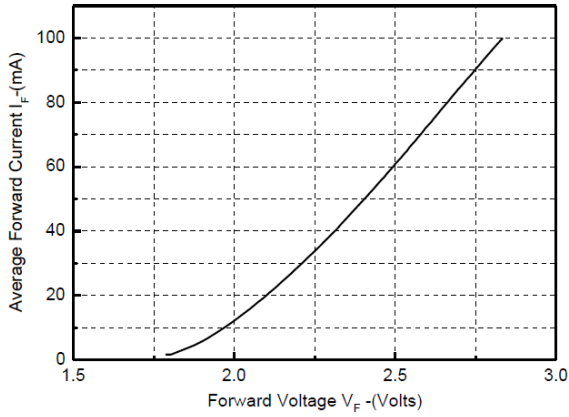

Relative Luminous Flux VS. Forward Current

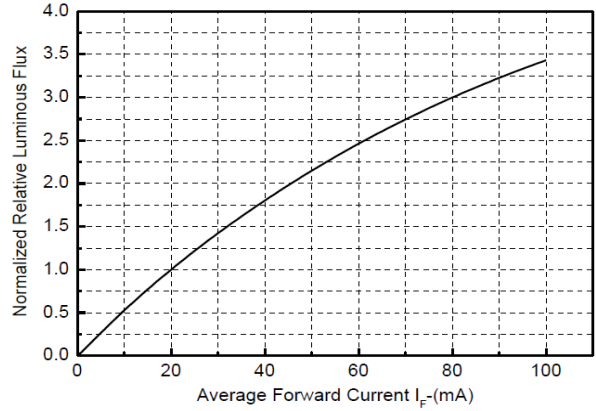

Maximum Driving Forward DC Current VS. Ambient Temperature

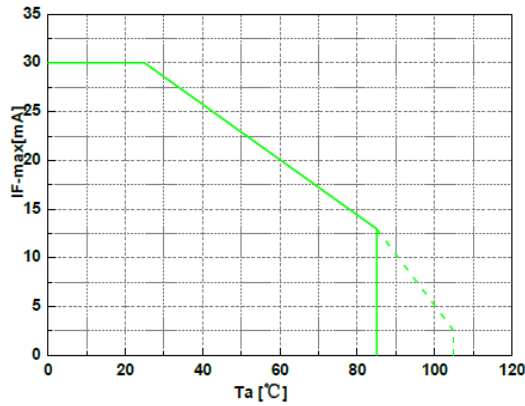

Relative Intensity vs. Wavelength

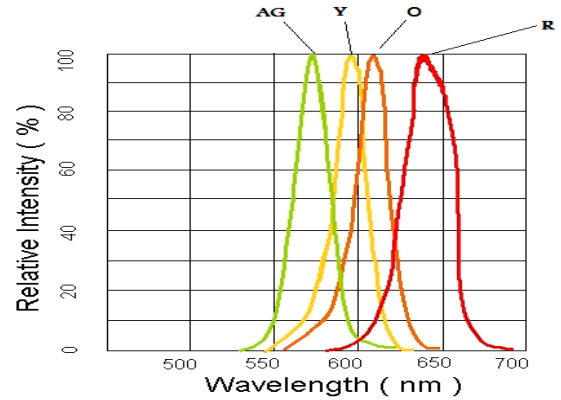

Directive Characteristics (Ta=25°C)

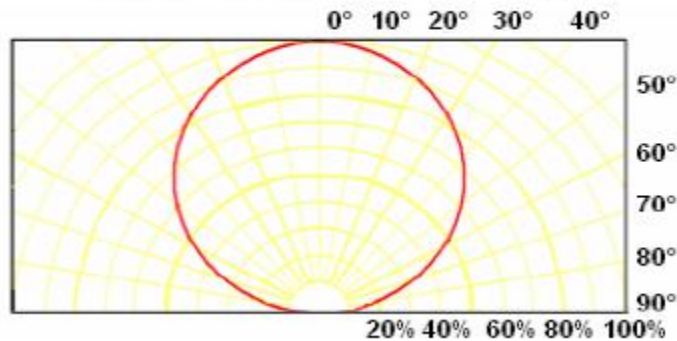

InGaN (IB/IG)

Forward Current VS. Forward Voltage

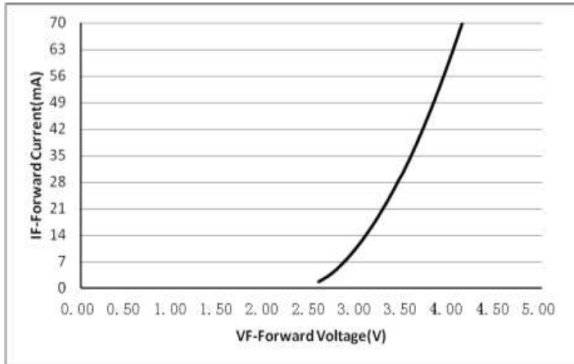

Relative Luminous Flux VS. Forward Current

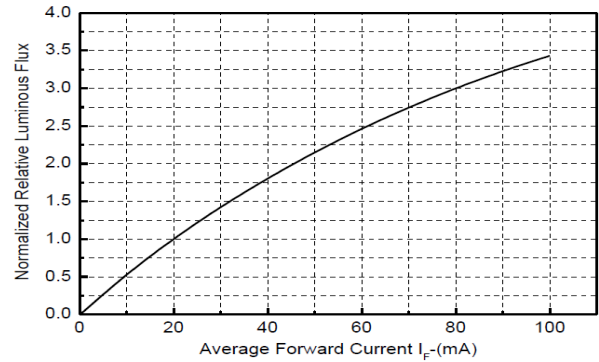

Maximum Driving Forward DC Current VS. Ambient Temperature

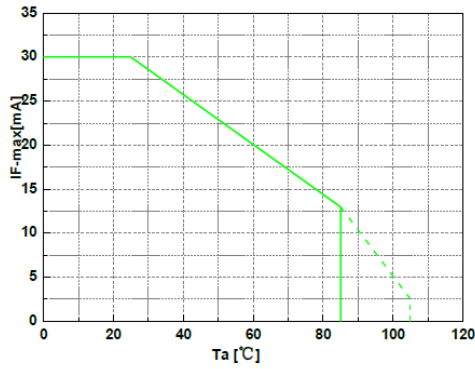

Relative Intensity vs. Wavelength

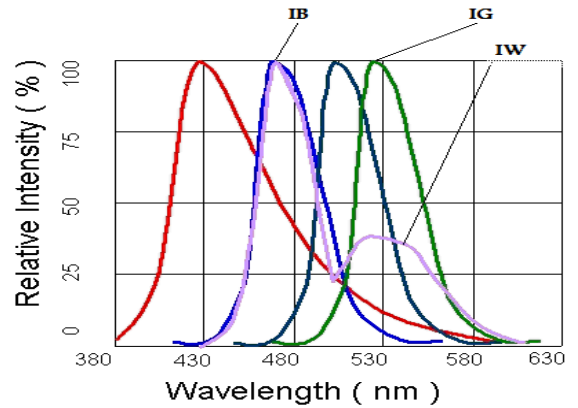

Directive Characteristics (Ta=25°C)

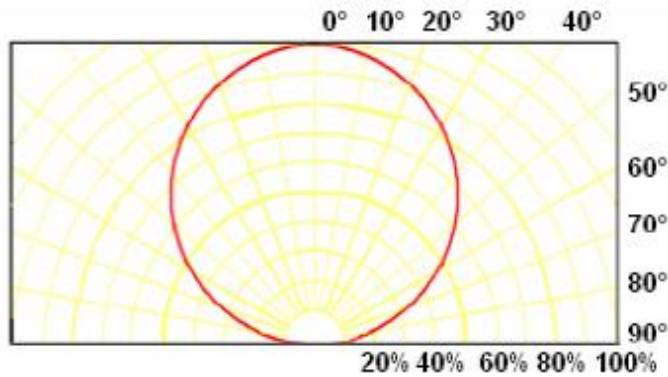

Solder Profile & Footprint

- Recommended tin solder specifications: melting temperature in the range of 178~192 °C
- The recommended reflow soldering profile is as follows (temperatures indicated are as measured on the surface of the LED resin):

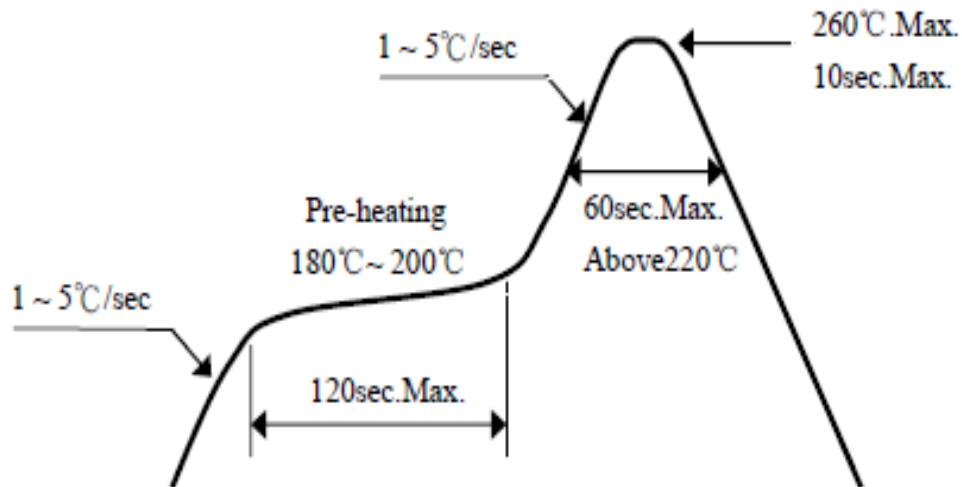

Recommended Soldering Pad Pattern

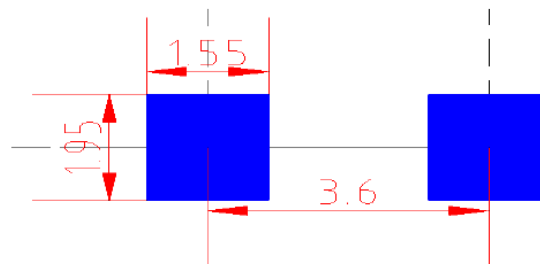

Units: mm / tolerance = +/-0.2mm

Packing

Reel Dimension:

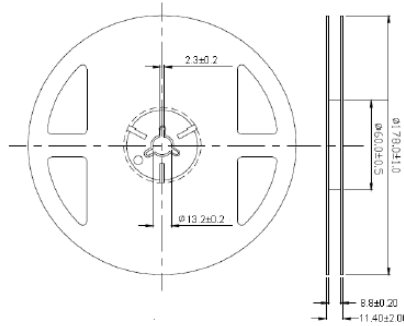

Unit: mm

Tape Dimension:

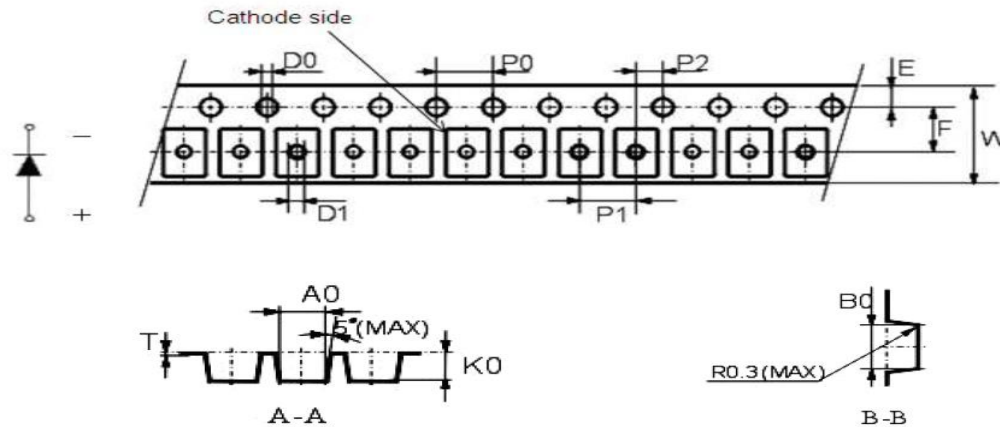

symbol	A0	B0	K0	P0	P1	P2
Spec	3.15±0.10	3.80±0.10	2.10±0.10	4.00±0.10	4.0±0.10	2.00±0.10
symbol	W	T	E	F	D0	D1
Spec	8.00±0.1	0.235±0.05	1.75±0.10	3.5±0.10	1.50±0.10	1.00±0.10

Unit: mm

Packaging Specification:

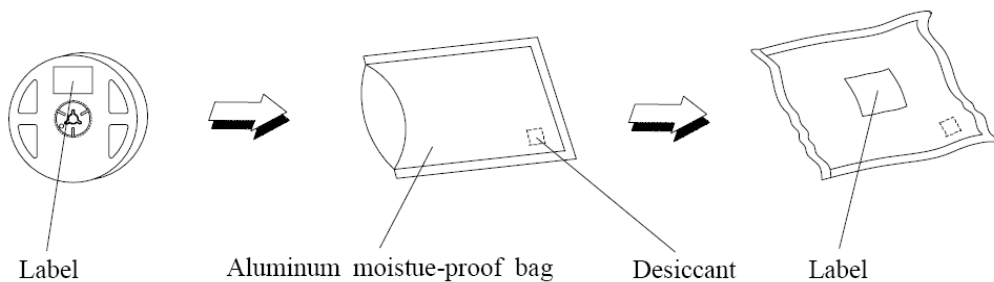

Labeling

Part No: _____

Customer P/N: _____

Item: _____

Q'ty: _____

Vf: _____

Iv: _____

WI: _____

Date: _____

Made in China**Ordering Information**

Part #	Orderable Part #	Spec Range	Quantity per reel
QBLP671E-IB	QBLP671E-IB	Iv=300mcd typ. @ 20mA/ $\lambda_D=465\text{nm}$ typ.	2,000 units
QBLP671E-IG	QBLP671E-IG	Iv=1500mcd typ. @ 20mA/ $\lambda_D =525\text{nm}$ typ.	2,000 units
QBLP671-R	QBLP671-R	Iv=900mcd typ. @ 20mA/ $\lambda_D=625\text{nm}$ typ.	2,000 units
QBLP671-O	QBLP671-O	Iv=900mcd typ. @ 20mA/ $\lambda_D= 605\text{nm}$ typ.	2,000 units
QBLP671-S	QBLP671-S	Iv=200mcd typ. @ 20mA/ $\lambda_D=640\text{nm}$ typ.	2,000 units

Revision History

Description:	Revision #	Revision Date
New Release of QBLP671_series	V1.0	03/18/2015
Add Note on Page 4	V1.1	07/08/2015
Update spec and add binning	V1.2	06/08/2016
Update the Forward Current vs. Ambient Temperature Graph/ Amend Green IV and WLD bin	V1.3	02/09/2017
Fix typo on the deep red (S) polarity / Update bin info	V1.4	11/21/2017

Disclaimer

QT-BRIGHTTEK reserves the right to make changes without further notice to any products herein to improve reliability, function or design. QT-BRIGHTTEK does not assume any liability arising out of the application or use of any product or circuit described herein; neither does it convey any license under its patent rights, nor the rights of others.

Life Support Policy

QT-BRIGHTTEK's products are not authorized for use as critical components in life support devices or systems without the express written approval of QT-BRIGHTTEK. As used herein:

1. Life support devices or systems are devices or systems which, (a) are intended for surgical implant into the body, or (b) support or sustain life, and (c) whose failure to perform when properly used in accordance with instructions for use provided in the labeling, can be reasonably expected to result in a significant injury of the user.
2. A critical component in any component of a life support device or system whose failure to perform can be reasonably expected to cause the failure of the life support device or system, or to affect its safety or effectiveness.