

μEZ[®] GUI User's Manual

Covers the following products:

UEZGUI-1788-43WQR (Dev Kit)

UEZGUI-1788-WQR-BA (Board Assembly)

UEZGUI-1788-43WQT (Dev Kit)

UEZGUI-1788-WQT-BA (Board Assembly)



43WQR Main Menu

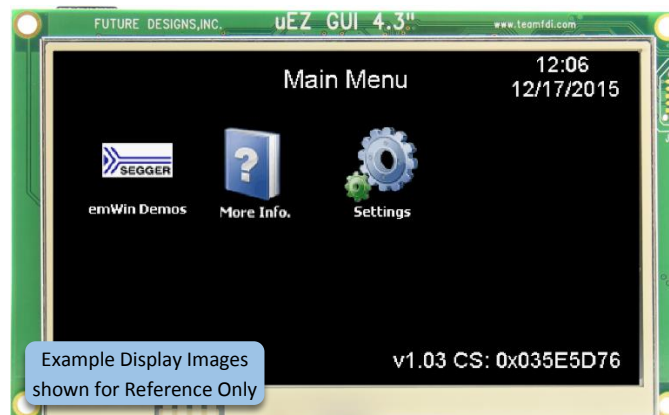

43WQT Main Menu

NOTICE: At FDI we are constantly improving our documentation. Please get the latest version of this document in the documentation tab of the product page at www.TeamFDI.com

FDI *Future Designs, Inc.*
Your Development Partner
996 A Cleaner Way, Huntsville, AL 35805

Table of Contents

1. Introduction	5
2. Block Diagram	5
3. Kit Contents	6
4. Useful links	6
5. Functional Description	6
6. Startup procedure	7
7. Demonstration Software Main Menu	7
a) Example Apps	7
b) Slideshow	8
c) Settings	8
8. Setting up a Slideshow	9
9. Setting up a Video	9
10. uEZ Doxygen online HTML documentation	10
11. uEZ Project Maker	10
12. Software	10
13. Board Layout	12
14. I/O Connector Descriptions	12
J5 - JTAG Connector	12
J12 - Tag Connect	13
J4 - MicroSD Socket	14
J3 - ISP Connector (not loaded)	16
J10 - Alternate Power and communication (loaded)	16
P1 – USB mini-AB port and USB Power Input 5VDC	16
J2 & J6 - Expansion Connectors	17
J2 & J6 - Expansion Connector Cable Details	21
15. Schematics	21
16. Temperature Range	21
17. Real Time Clock Backup Time	21
18. ESD Warning	21
19. Power Requirements	22

20.	<i>Mechanical Details</i>	23
21.	<i>Updating to UEZGUI-1788-43WQR-BA from UEZGUI-XXXX-43WQS-BA</i>	25

Important Legal Information

Information in this document is provided solely to enable the use of Future Designs products. FDI assumes no liability whatsoever, including infringement of any patent or copyright. FDI reserves the right to make changes to these specifications at any time, without notice. No part of this document may be reproduced or transmitted in any form or by any means, electronic or mechanical, for any purpose, without the express written permission of Future Designs, Inc. 996 A Cleaner Way, Huntsville, AL 35805.

For more information on FDI or our products please visit www.teamfdi.com.

NOTE: The inclusion of vendor software products in this kit does not imply an endorsement of the product by Future Designs, Inc.

© 2016 Future Designs, Inc. All rights reserved.

uEZ® is a registered trademark of Future Designs, Inc.

Microsoft, MS-DOS, Windows, Windows XP, Microsoft Word are registered trademarks of Microsoft Corporation.

Other brand names are trademarks or registered trademarks of their respective owners.

FDI PN: MA00028

Revision: 12.0, 01/18/2016

Printed in the United States of America

1. Introduction

The UEZGUI-1788-43WQR-BA & UEZGUI-1788-43WQT-BA provide a quick and easy solution for implementing a Graphical User Interface (GUI) based design by providing the basic functions necessary for most customer products.

Part Number	Touch Type	Notes
UEZGUI-1788-43WQR & WQR-BA	4 wire resistive	GPIO and ADC utilized for touch interface
UEZGUI-1788-43WQT & WQT-BA	No touch	No I/O Utilized

Note: Any mention of UEZGUI-1788-43WQR also includes the UEZGUI-1788-43WQT unless otherwise noted.

2. Block Diagram

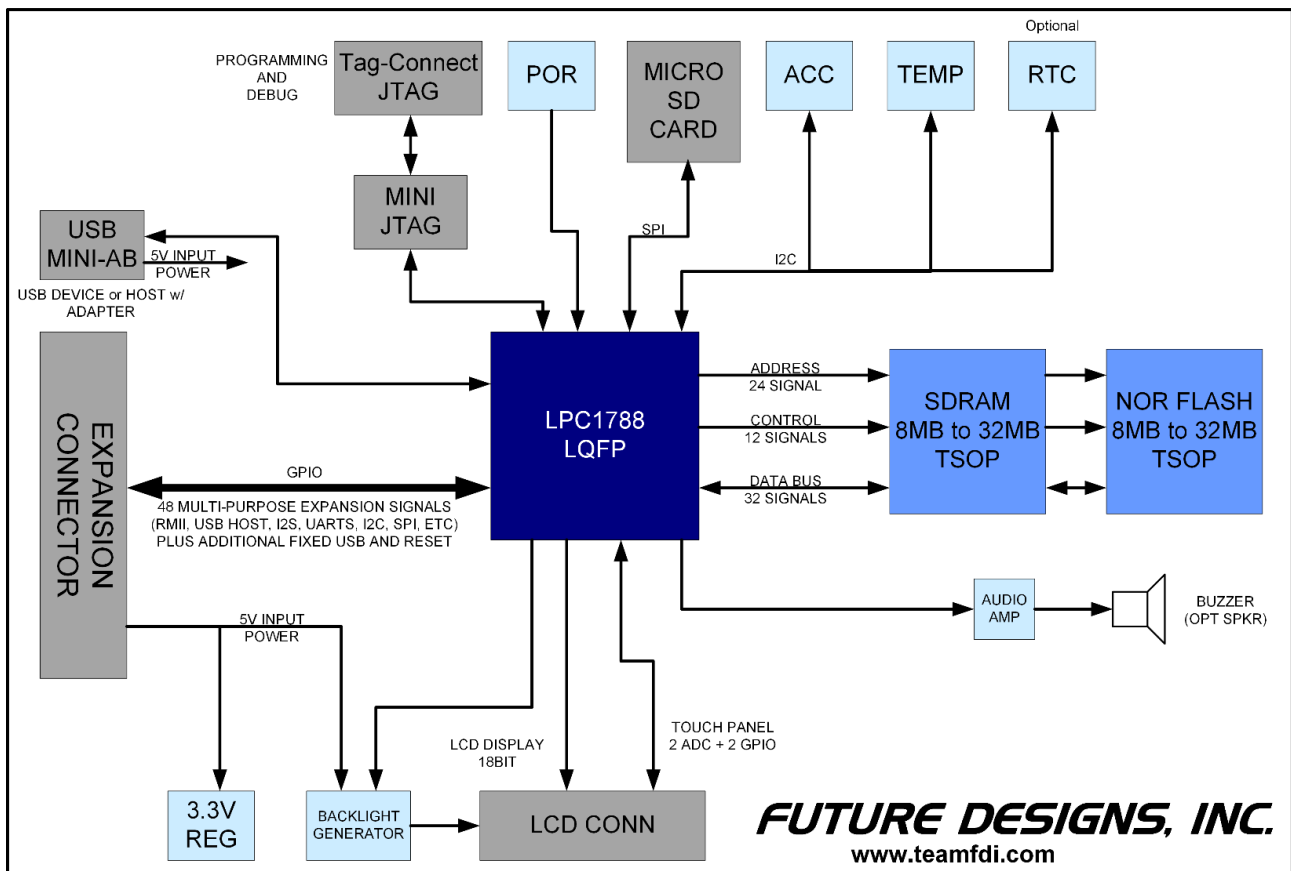

Figure 1 – UEZGUI-1788-43WQR-BA Block Diagram

3. Kit Contents

- UEZGUI-1788-43WQR-BA Resistive Touch Screen LCD Board Assembly
or
- UEZGUI-1788-43WQT-BA No-Touch LCD Board Assembly
- Segger Mini-JTAG Debugger and cable
- FDI JTAG Adapter Board
- Micro SD card
- USB Cable (A to mini B)
- AC to USB Power Supply
- Stylus for Touch Screen (not included with no touch kit)
- Quick Start Guide

4. Useful links

Complete Users Manuals, Schematics, and documentation are available on the Micro-SD card provided with the μEZ GUI Kit and are also available from the following websites (please refer to the websites for the latest updates):

- Future Designs Support Page - <http://www.teamfdi.com/support/>
- μEZ Source Code, users manuals, and quickstart guides - <https://sourceforge.net/projects/uez/>
- Segger Mini-JTAG Debugger - <http://www.segger.com/cms/jlink-software.html>
- Rowley Crossworks IDE download for 30-day evaluation - <http://www.rowley.co.uk/arm/index.htm>

5. Functional Description

- LPC1788 Cortex-M3 based Microprocessor
- SDRAM 8MB, optional up to 32MB
- NOR FLASH 8MB, optional up to 32MB
- Serial EEPROM with Access Protection (optional)
- Internal 4kB EEPROM
- RTC – Real Time Clock
- Temperature Sensor
- 3-axis Accelerometer
- Speaker
- Micro-SD Card Socket for up to 64GB storage
- Mini JTAG
- Power-on Reset Generator - power-on reset supervisor and voltage monitor (SW1)
- Expansion Connector for customer specific applications
- USB Host or Device support through mini B/AB connector and adapter

6. Startup procedure

The μEZ GUI kit comes with a pre-installed micro SD card that contains files required for the demo applications and slide show to run. It also contains user's manuals, schematics, and documentation for the product.

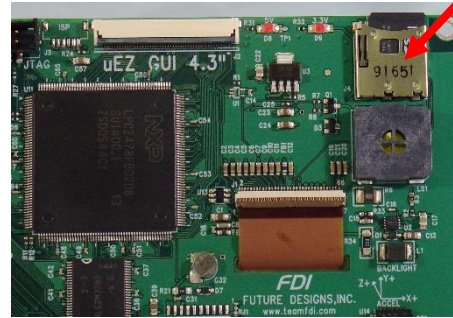
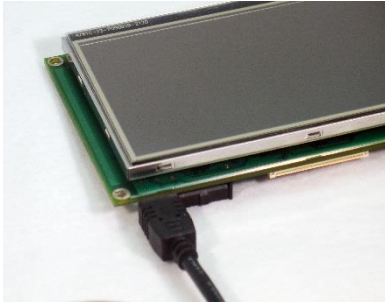

Power is supplied via the USB cable provided in the kit. Connect the USB cable to the mini B USB connector.

Depending on the version you are using, one of the following screens should appear once power has been applied to the kit:

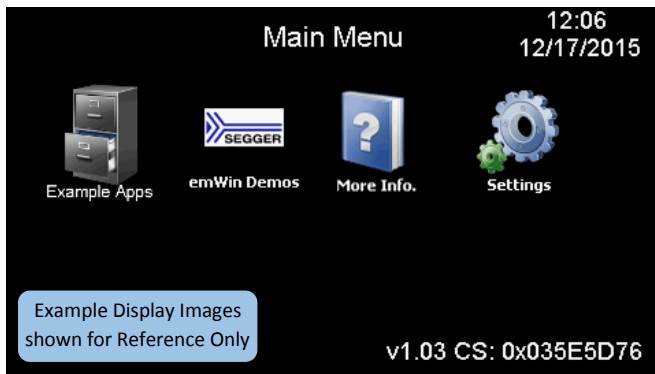

43WQR Screen

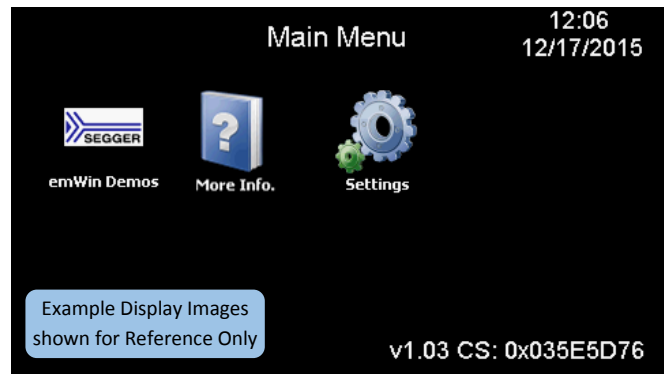

43WQT Screen

The unit is now ready for software demonstrations and user operation.

By connecting the USB A to mini B cable to P1, the μEZ GUI will also appear as a USB Flash Drive to the PC, allowing the user to read/write files directly to the Micro SD card.

7. Demonstration Software Main Menu

Note: The Demonstration Software is subject to change at any time.

The following software demonstrations are available from the Main Menu:

a) Example Apps

Selecting the Example Apps icon will load the Example Applications Screen with the following options:

- **Main Menu** – this will return the μEZ GUI to the Main Menu of the demonstration software. The μEZ GUI will load the application and reboot.

- **Bowling** – This demonstration is an example of a bowling alley user interface.
- **Project Maker** – This is a demonstration example application developed using the Project Maker utility from Future Designs. Currently, this demonstration is a Temperature and Time/Date application.
 - **Temperature**

Select the temperature icon to display external and internal temperatures. The μEZ GUI will display an external temperature at any time. However, it is only valid when an external temperature sensor has been connected to the μEZ GUI hardware. [Diligent Inc.](#) sells a temperature sensor, [part number 410-287P](#), that could be used for this purpose. The internal temperature is read from the [LM75 temperature sensor](#). There are no user changeable parameters. To return to the main menu, select 'Back'.
 - **Time and Date**

Select this feature to display the current time and date from the internal real time clock (RTC).

 - To change the time or date:
 1. Select the field you want to change.
 2. Enter the numeric value.
 3. Select 'Enter'.
 4. Select 'Cancel' if you do not want to change the field. Or, wait until the entry screen times out and returns to the Time Date Settings screen.
 - If invalid values are entered, the software will default to the maximum valid value for the field.
 - Once set, an on-board super capacitor will back-up the time and date for several days (typically) while the unit is powered off.
 - Select 'Back' to return to the Settings Menu.
- **Temp. Graph** – This is a demonstration example of a graphing application recording temperature and humidity.

b) Slideshow

Selecting the slideshow icon will use the microSD card to read slideshow configuration. This allows the user to select between several slideshow options such as “μEZ GUI Family Overview”, “Demonstration Pictures”, “uEZ Software Overview”, “Modular Development Kit”, etc. depending on the configuration of the SD Card.

Select the slideshow you would like to view by touching the menu entry for it on the touch screen. The slide show will auto-play by default.

By touching the screen during the slideshow, the menu overlay will appear:

- Select the “| |” button to pause the slideshow.
- Select the play button to begin the automated slide show.
- The user can move to the next slide by touching the “>” or “<” menu buttons (during auto-play or manual sequencing)
- Select the stop (square block) to return to the slideshow menu.
- Select 'Back' from the slideshow menu to return to the previous menu.

c) Settings

Brightness

Selecting the brightness icon shows a menu with color bars and a brightness adjustment slider.

- Move the slider up or down to adjust the brightness.
- Select 'Back' to return to the Settings Menu.

Time/Date

Use this application to set the time and date from the internal real time clock (RTC). This is the time and date displayed in the Settings menu upper right corner.

- To change the time or date simply select the field you want to change:
 1. Enter the numeric value
 2. Select 'Enter'
 3. Select 'Cancel' if you do not want to change the field, or simply wait until the entry screen times out and returns to the Time Date Settings screen
- If invalid values are entered, the software will default to the maximum valid value for the field.
- Once set an on-board super capacitor will back-up the time and date for several days (typically) while the unit is powered off.
- Select 'Back' to return to the Settings Menu.

Vol. Contr.

This feature displays the 'Master', 'Speaker', and 'Headphones' volume sliders, along with 'Mute' checkboxes. 'Master' controls the volume of the unit as a whole, 'Speaker' controls the volume coming from the onboard speaker, and 'Headphones' controls the audio being output if your board has a headphone jack installed.

8. Setting up a Slideshow

We have created a document and included tools for creating your own slideshows for μEZ GUI units. Production module units require 24-bit uncompressed Targa (.TGA) format for all images. Development kit units require bitmap (.BMP) format for all slideshow images.

<http://www.teamfdi.com/wp-content/uploads/Slideshow-Creation-Guide.pdf>

This guide also covers making speaker notes that can play alongside your slides.

9. Setting up a Video

Suggested procedures on creating videos for playback using the uEZ video player provided in uEZ v2.05 (and later) on supported uEZ GUI hardware, is available in the FDI Video Creation Guide (link below). This guide also suggests basic procedures for downloading videos from YouTube.

This guide assumes that a source video is available in AVI uncompressed format with a resolution of 480×272 or greater.

Video Creation Guide:

<http://www.teamfdi.com/support/uez/Video/uEZ%20Auto%20Video%20Conversion%20Guide.pdf>

10. μEZ Doxygen online HTML documentation

μEZ has built-in comment documentation that follows the Doxygen comment standard. This standard writes code comments and annotations in a certain manner so that it is compiled along with source code into HTML documentation.

FDI provides pre-compiled HTML documentation at this link: <http://www.teamfdi.com/uez/docs/>

In the uEZ source code, “uEZ/uEZDoxyfile” is the main project file for the Doxygen generator. When Doxygen is recompiled, the new Doxygen files will be found here: uEZ\Docs\ Doxygen_Documentation.html

FDI updates the documentation periodically. We recommend reviewing your device for updates to the documentation as you learn a new μEZ® release or drivers are added to the system.

For more information, see the Doxygen website: <http://www.doxygen.org/>.

11. μEZ Project Maker

FDI has provided a project maker to help create new projects for μEZ GUI hardware. It is available for download at <http://sourceforge.net/projects/uez/>.

To create a new project, download the application, run the executable file, and follow the onscreen instructions. It will create a demo project using an emWin example GUI that will provide basic peripheral functionality. The project maker greatly speeds up the development process for new applications. Example projects are ready to be compiled and programmed onto μEZ GUI hardware using the included J-Link debugger, with no extra project configuration necessary.

12. Software

μEZ® takes its name from the Muses of Greek mythology. A muse was a goddess who inspired the creation process for the arts and sciences. Like its ancient Greek namesake, the μEZ® platform inspires rapid development by supplying customers with an extensive library of open source software, drivers, and processor support - all under a common framework. μEZ® development works on the premise of “design once, reuse many times”. This provides an open source standard for embedded developers to build upon and support. μEZ® allows companies to focus on innovation and on their own value-added applications while minimizing development time and maximizing software reuse.

The diagram below shows a typical embedded application stack. μEZ® has three primary categories of components that help simplify embedded application development:

- 1. Operating System Abstraction Layer (μEZ® OSAL)**
- 2. Sub-system drivers (μEZ® TCP/IP, μEZ® USB, μEZ® Driver)**
- 3. Hardware Abstraction Layer (μEZ® HAL)**

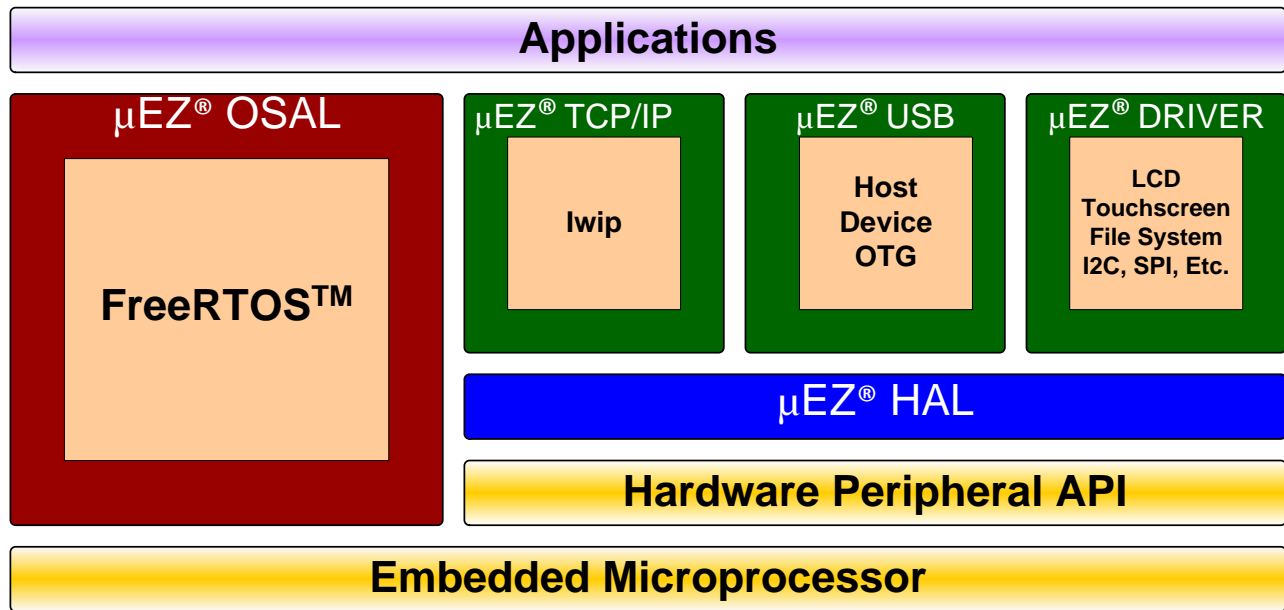

Selecting an RTOS can be one of the most daunting aspects of an embedded system development. With μEZ® the primary features of common multi-tasking operating systems are abstracted, thus easing the transition to an open source or low-cost RTOS. The μEZ® OSAL provides applications access to the following features in an OS-independent fashion:

- Pre-emptive multitasking
- Stack overflow detection
- Unlimited number of tasks
- Queues
- Semaphores (binary, counting, mutex)

The μEZ® sub-system drivers utilize the OSAL functions to provide protected access to the processor peripherals. The sub-system driver API functions are typically protocol layer interfaces (TCP/IP, USB, etc) designed as high-level access routines such as open, close, read, write, etc. where possible.

μEZ® is ideally suited for Embedded Systems with standard features such as:

- Processor and Platform BSPs (Board Support Packages)
- Real Time Operating System (RTOS)
- Memory Management
- NAND/NOR Flash
- SDRAM and DDR Memory
- TCP/IP stack
- USB Device/Host Libraries
- Mass Storage Devices
- LCD Displays with Touch Screen
- Input / Output Devices

13. Board Layout

The following figure illustrates the layout of the various components of the UEZGUI-1788-43WQR kit. They are for reference only and are subject to change.

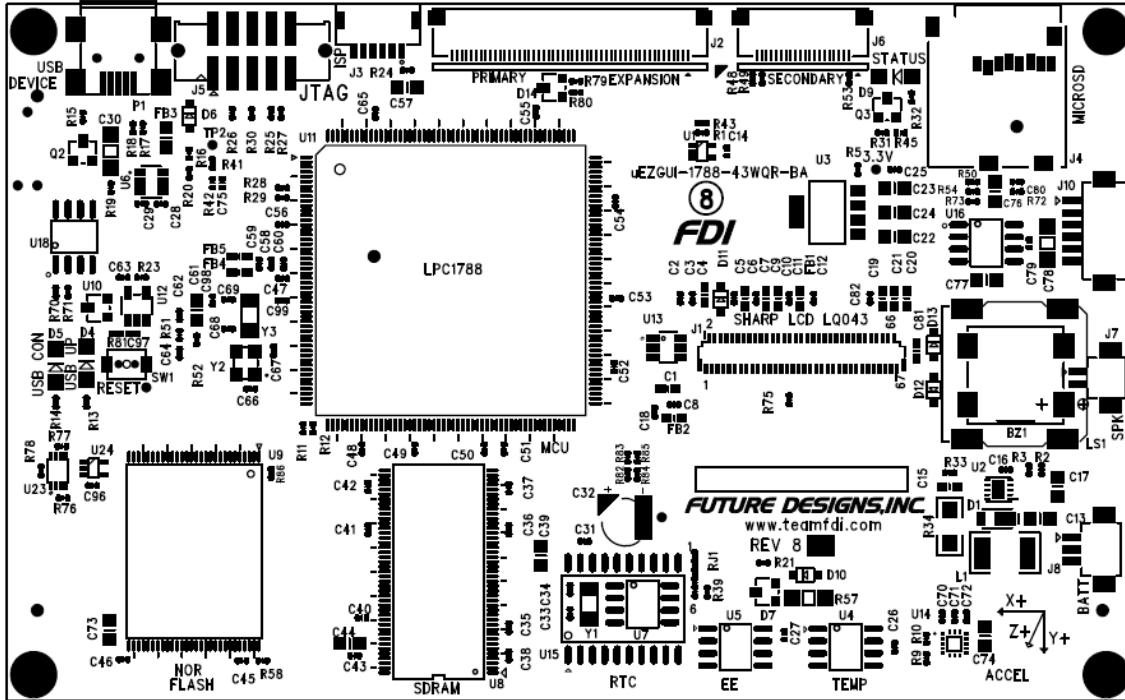

Figure 2 – UEZGUI-1788-43WQR Component View

14. I/O Connector Descriptions

J5 - JTAG Connector

UEZGUI-1788-43WQR-BA uses a reduced size JTAG connector based on a 2mm Header. This smaller connector provides 100% of the functionality of the standard 20-pin JTAG connector but utilizes 70% less board space. The connector is a standard part available from most major vendors.

Pin Number	Description	Pin Number	Description
1	GND	6	RTCK
2	5.0V	7	TDI
3	TDO	8	TMS
4	RESETn	9	3.3V
5	TCK	10	TRSTn

For users that may have existing JTAG debuggers, an adapter may be fabricated using the following wiring diagram: (part numbers for the connectors are included from both the manufacturer and Digi-Key)

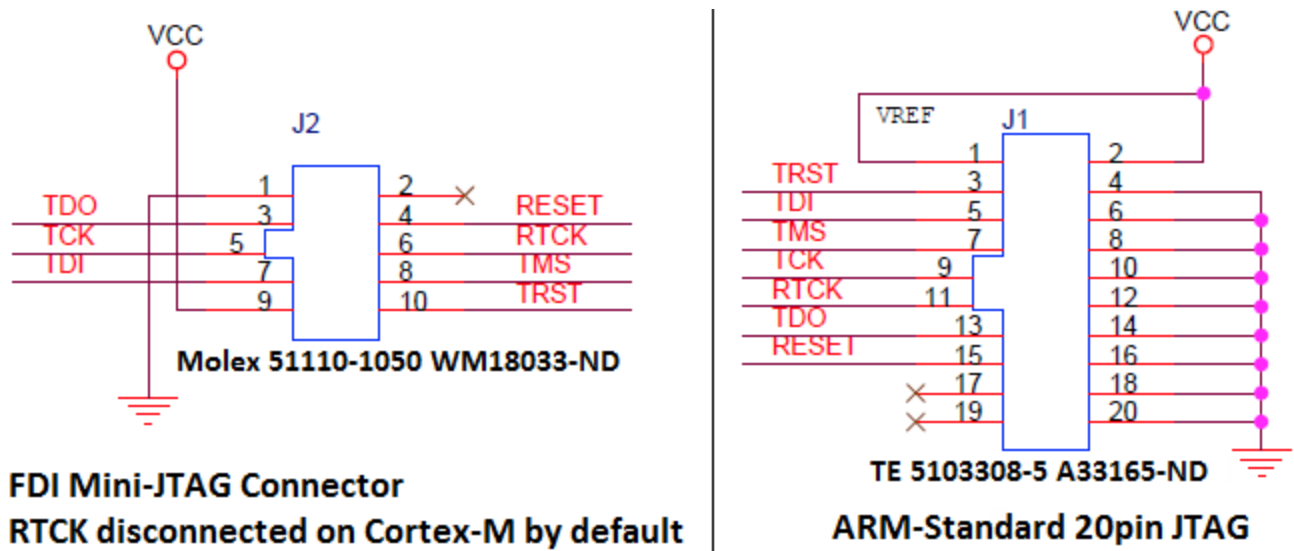

Figure 3 – Mini JTAG Adapter Schematic

J12 - Tag Connect

The UEZGUI-1788-WQN-BA also includes the ability to JTAG and program using the Tag-Connect TC2050-ARM2010 ARM 20-pin to TC2050 Adapter.

- Adapter: <http://www.tag-connect.com/TC2050-ARM2010>
- Cable with legs: <http://www.tag-connect.com/TC2050-IDC>
- Cable with no legs: <http://www.tag-connect.com/TC2050-IDC-NL>
- Holding clip for no-legs cable version: <http://www.tag-connect.com/TC2050-CLIP>



Figure 4 – Tag-Connect JTAG adapter, cables, and pinout for 10-pin TC2050

J4 - MicroSD Socket

When connected to the USB Host port on a PC, the UEZGUI-1788-43WQR- BA will appear as a USB Flash Drive to the PC. This allows the user to read and write files directly to the microSD card. The unit uses a microSD Socket for flexible mass storage capability.

Pin Number	Description
1	NC
2	Micro SD Chip Select
3	Micro SD MOSI
4	3.3V
5	Micro SD SCLK
6	Ground
7	Micro SD MISO
8	NC

WARNING: The microSD card must only be removed using the spring loaded “push-pull” mechanism on the microSD socket. Improper forceful removal of the microSD card will result in permanent damage to the socket that is not covered under warranty. To insert the card, just push it into the socket until a “click” sound is heard.

Start with the microSD card in this position relative to the microSD slot with the text and “lip” facing up.

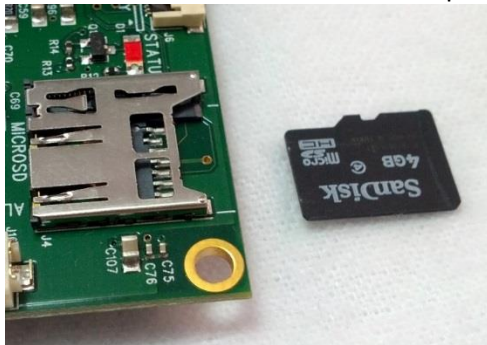

Next gently insert the card partially into the socket.



Use your figure to gently push the card into the socket until it clicks.

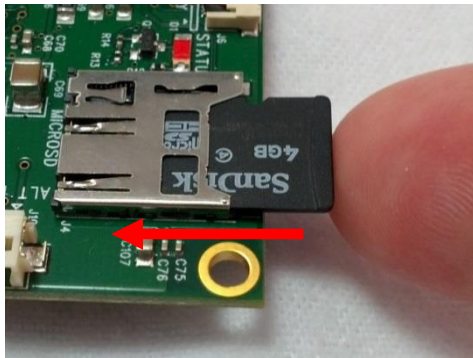

At this point the microSD card is fully inserted. It should not fall out, even if the unit is shaken vigorously.



To remove the microSD card, press the card back into the socket until another “click” sound is heard, then release pressure on the card. At this point, the card should be partially ejected from the socket. Finally grab the card and gently pull to remove it. See the following pictures for proper micro-SD removal:

To remove the microSD card, gently push it into the socket again until it “clicks”, and then release your finger.

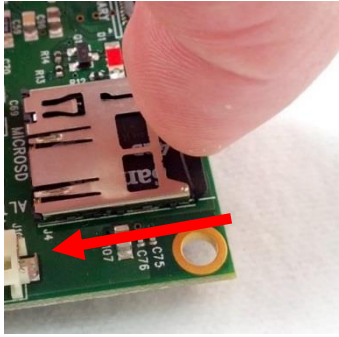

At this point, the microSD card should partially stick out of the socket.



Carefully grab the edges or sides of the microSD card and gently pull it out.



At this point the microSD card is fully removed from the socket.

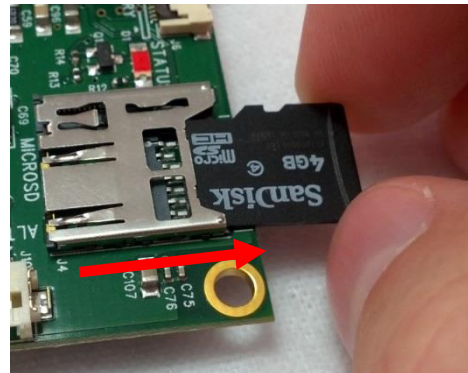

J3 - ISP Connector (not loaded)

The UEZGUI-1788-43WQR-BA is laid out with an ISP programming header. This header is designed to be utilized with the USB-ICP-LPC2K programmer from FDI. However, the connector on the UEZGUI-1788-43WQR-BA is not directly compatible with the one used on the USB-ICP. This connector is a 1.25mm Hirose male, shrouded connector. The Hirose Part Number is: DF13A-6P-1.25H(20) (Digikey PN: H3371-ND). The pin out shown below is a direct, 1:1 connection to the USB-ICP-LPC2K programmer available from Future Designs, Digi-Key or Mouser.

Pin Number	Description
1	3.3V
2	Reset Input
3	ISP Entry
4	Ground
5	RXD
6	TXD

J10 - Alternate Power and communication (loaded)

The UEZGUI-1788-43WQR-BA is laid out with an alternate power and communication header. This header provides access to UART 3, as well as a 5V power input. This connector is a 1.25mm Hirose male, shrouded connector. The Hirose Part Number is: DF13A-6P-1.25H(20) (Digikey PN: H3371-ND).

Pin Number	Description
1	P0.10_TXD2_SDA2
2	5V Input
3	5V Input
4	Ground
5	Ground
6	P0.11_RXD2_SCL2

P1 – USB mini-AB port and USB Power Input 5VDC

The UEZGUI-1788-43WQR-BA has a mini-AB USB connector for host or device mode. By using a USB OTG adapter (with a mini-A plug) it will short the ID pin 4 to ground. This can be used for host mode detection in the application. The UEZGUI-1788-43WQR-BA is normally powered via P1 with the included 5V USB Wall Supply or via a standard 500mA powered USB port. This power supply is only included in the development kit and is not included with the UEZGUI-1788-43WQR-BA (production module).

Pin Number	Description
1	5V
2	D-
3	D+
4	ID
5	Ground

J2 & J6 - Expansion Connectors

The UEZGUI-1788-43WQR-BA includes two expansion connectors that provide a wide variety of capabilities for user expansion, ranging from 10/100 Ethernet to USB Host, etc.

Note: When using I/O signals on the uEZ GUI Expansion Connectors (J2 & J6) to connect a third party expansion board to external connectors or signals, you must confirm adequate ESD protection and filtering through the third party to prevent damage to any pins that are not directly protected on the uEZ GUI.

The tables below provide the pinout and signal names available on these connectors:

J2 Signal Details

Pin	Pin Name	Pin Description	
1	Ground (GND)		Power
2	P0.11_RXD2_SCL2_MAT3.1	P0[11] - General purpose digital Input/Output pin.	I/O
		RXD2 - Receiver input for UART2.	I
		SCL2 - I2C2 clock Input/Output (this is not an open-drain pin)	I/O
		MAT3[1] -Match output for Timer3, channel 1.	O
3	P0.10_TXD2_SDA2_MAT3	P0[10] - General purpose digital input/output pin.	I/O
		SDA2 - I2C2 data input/output (this is not an open-drain pin).	I/O
		MAT3[0] - Match output for Timer3, channel 0.	O
		TXD2 -Transmitter output for UART2.	O
4	P0.20_DTR1_SCL1	P0[20] - General purpose digital input/output pin.	I/O
		DTR1 - Data Terminal Ready output for UART1	O
		SCL1 - I2C1 clock input/output (this is not an open-drain pin)	I/O
5	P0.19_DSR1_SDA1	P0[19] - General purpose digital input/output pin.	I/O
		SDA1-I2C1 data input/output (this is not an open-drain pin).	I/O
		DSR1 - Data Set Ready input for UART1.	I
6	P0.22_RTS1	P0[22] - General purpose digital input/output pin.	I/O
		RTS1 - Request to Send output for UART1.	O
7	P0.17_CTS1_MISO_MIS00	P0 [17] - General purpose digital input/output pin	I/O
		CTS1 - Clear to Send input for UART1.	I
		MISO - Master In Slave Out for SPI.	I/O
		MIS00 - Master In Slave Out for SSP0.	I/O
8	P0.16_RXD1_SSELO	P0[16] - General purpose digital input/output pin.	I/O
		SSELO - Slave Select for SP0.	I/O
		RXD1 - Receiver input for UART1.	I
9	P0.15_TXD1_SCK0_TXD1_SCK	P0[15] - General purpose digital input/output pin.	I/O
		SCK0 - Serial clock for SSP0.	I/O
		TXD1 – Transmitter output for UART1.	O
		SCK - Serial clock for SPI.	I/O
10	Ground (GND)		Power
11	USB1_DM	P0[30] - General purpose digital Input/Output pin.	I/O
		USB_D- 1 - USB port 1 bidirectional D- line.	I/O
12	USB1_DP	P4[29] - General purpose digital Input/Output pin.	I/O
		USB_D+1 - USB port 1 bidirectional D+ line.	I/O
13	USB1H_PWRD	P4[26] -General purpose digital Input/Output pin.	I/O
		BLS0 - LOW active Byte Lane select signal 0.	O
14	USB1H_OVC	P4[24] - General purpose digital Input/Output pin.	I/O
15	USB1H_PPWR	P0[19] - General purpose digital Input/Output pin.	I/O
		CAP1[1] - Capture input for Timer 1, channel 1	I
		USB_PPWR1 - Port Power enable signal for USB port 1.	O
16	P0.9_I2STX_SDA_MOSI1_MAT2.3	I/O	I/O

Pin	Pin Name	Pin Description	
		I2STX_SDA - I2S transmit data. It is driven by the transmitter and read by the receiver. Corresponds to the signal SD in the I2S-bus specification.	I/O
		MAT2[3] - Match output for Timer 2, channel 3	O
		MOSI1 - Master Out Slave In for SSP1.	I/O
17	P0.8_I2STX_WS_MISO1_MAT 2.2	P0[8] - General purpose digital Input/Output pin.	I/O
		I2STX_WS - I2S Transmit word select. It is driven by the master and received by the slave. Corresponds to the signal WS in the I2S-bus specification.	I/O
		MAT2[2] - Match output for Timer 2, channel 2	O
		MISO1 - Master In Slave Out for SSP1.	I/O
18	P0.7_I2STX_CLK_SCK1_MAT 2.1	P0[7] - General purpose digital Input/Output pin.	I/O
		I2STX_CLK - I2S transmit clock. It is driven by the master and received by the slave. Corresponds to the signal SCK in the I2S-bus specification.	I/O
		MAT2[1] - Match output for Timer 2, channel 1	O
		SCK1 - Serial Clock for SSP1.	I/O
19	P0.6_I2SRX_SDA_SSEL1_MAT2.0	P0[6] - General purpose digital Input/Output pin	I/O
		I2SRX_SDA - I2S Receive data. It is driven by the transmitter and read by the receiver. Corresponds to the signal SD in the I2S-bus specification.	I/O
		SSEL1 - Slave Select for SSP1.	I/O
		MAT2[0] - Match output for Timer 2, channel 0	O
20	P0.5_I2SRX_WS_TD2_CAP2.1	P0[5] - General purpose digital Input/Output pin.	I/O
		I2SRX_WS - I2S Receive word select. It is driven by the master and received by the slave. Corresponds to the signal WS in the I2S-bus specification.	I/O
		TD2 - CAN2 transmitter output.	O
		CAP2[1] - Capture input for Timer 2, channel 1	I
21	P0.4_I2SRX_CLK_RD2_CAP2.0	P0[4] - General purpose digital Input/Output pin.	I/O
		I2SRX_CLK - I2S Receive clock. It is driven by the master and received by the slave. Corresponds to the signal SCK in the I2S-bus specification.	I/O
		RD2 - CAN2 receiver input	I
		CAP2[0] - Capture input for Timer 2, channel 0	I
22	Ground (GND)		Power
23	RESET_INn	External reset input: A LOW on this pin resets the device, causing I/O ports and peripherals to take on their default states, and processor execution to begin at address 0. TTL with hysteresis, 5 V tolerant	I
24	RESET_OUTn	RSTOUT - This is a 3.3 V pin. LOW on this pin indicates LPC1788 being in Reset state	O
25	P0.26_AD03_AOUT_RXD3⁽¹⁾	P0[26] General purpose digital Input/Output pin.	I
		AD0[3] - A/D converter 0, input 3.	O
		AOUT - D/A converter output.	I
		RXD3 - Receiver input for UART3	I/O
26	P1.31_SCK1_ADO.5	P1[31] - General purpose digital Input/Output pin.	I/O
		SCK1 - Serial Clock for SSP1.	I/O
		ADO[5] - A/D converter 0, input 5	I
OR		Select either P1.31 or P5.1 using R82, R83, R84, and R85.	
26	P5.1_SSP2MISO_T2MAT3	P5[1] - General purpose digital input/output pin.	I/O
		MOSI2 - Master Out Slave In for SSP2	O
		MAT2[2] - Match output for Timer 2, channel 2	O
27	P1.17_ENET_MDIO	P1[17] - General purpose digital Input/Output pin.	I/O
		ENET_MDIO - Ethernet MIIM data input and Output	I/O
28	P1.16_ENET_MDC	P1[16] - General purpose digital Input/Output pin.	I/O
		ENET_MDC - Ethernet MIIM clock	O
29	Ground (GND)		Power
30	P1.15_ENET_REFCLK	P1[15] - General purpose digital Input/Output pin.	I/O
		ENET_REF_CLK/ENET_RX_CLK - Ethernet Reference Clock (RMII interface)/ Ethernet Receive Clock (MII interface)	I
31	P1.14_ENET_RX_ER	P1[14] - General purpose digital Input/Output pin.	I/O
		ENET_RX_ER - Ethernet receive error (RMII/MII interface)	I

Pin	Pin Name	Pin Description	
32	3p3 volts	3.3 volts	Power
33	P1.10_ENET_RXD1	P1[10] – General purpose digital Input/Output pin.	I/O
		ENET_RXD1 - Ethernet receive data 1 (RMII/MII interface)	I
34	P1.9_ENET_RXD0	P1[9] - General purpose digital Input/Output pin.	I/O
		ENET_RXD0 - Ethernet receive data 0 (RMII/MII interface)	I
35	P1.8_ENET_CRSDV	P1[8] - General purpose digital Input/Output pin.	I/O
		ENET_CRSDV/ENET_CRSDV – Ethernet Carrier Sense/Data Valid (RMII interface)/ Ethernet Carrier Sense (MII interface)	I
36	P1.4_ENET_TXEN	P1[4] - General purpose digital Input/Output pin.	I/O
		ENET_TX_EN - Ethernet transmit data enable (RMII/MII interface)	O
37	P1.1_ENET_TXD1	P1[1] - General purpose digital Input/Output pin.	I/O
		ENET_TXD1 - Ethernet transmit data 1 (RMII/MII interface)	O
38	P1.0_ENET_TXD0	P1[0] - General purpose Digital Input/Output pin.	I/O
		ENET_TXD0 - Ethernet transmit data 0 (RMII/MII interface)	O
39	Ground (GND)		Power
40	P2.10_EINT0_NMI	I/O - P2[10] - General purpose digital Input/Output pin. Note: LOW on this pin while RESET is LOW forces on-chip boot loader to take over control of the part after a reset.	I/O
41	P0.3_RXD0	P0[3] - General purpose digital Input/Output pin.	I/O
		RXD0 - Receiver input for UART0	I
42	P0.2_TXD0	P0[2] - General purpose digital Input/Output pin.	I/O
		TXD0 - Transmitter output for UART0	O
43	USBD_DP	USB_D+2 - USB port 2 bidirectional D+ line	I/O
44	USBD_DM	USB_D-2 - USB port 2 bidirectional D- line	I/O
45	USBD_VBUS	USB_PWRD2 - Power Status for USB port 2.	I
		VBUS - Monitors the presence of USB bus power. Note: This signal must be HIGH for USB reset to occur. I - AD0[4] - A/D converter 0, input 4	I
46	5volts (5VO)	5.0 Volts	Power
47	5volts (5VO)	5.0 Volts	Power
48	5volts (5VO)	5.0 Volts	Power
49	3p3 volts (3V3)	3.3 Volts	Power
50	3p3 volts (3V3)	3.3 Volts	Power

On the UEZGUI-1788-43WQR Revision 7, J2-26 can be selectable for either P1.31, or P5.1. By default, neither pin is connected to the expansion board, and P1.31 is connected to the LCD. The following 0 ohm resistors are used to control which port pins are used: R82, R83, R84, and R85.

Pin on Expansion board	Pin on LCD	R82	R83	R84	R85
None	P1.31	No Load	No Load	Loaded	No Load
P1.31	P5.1	Loaded	No Load	No Load	Loaded
P5.1	P1.31	No Load	Loaded	Loaded	No Load

J6 Signal Details

Pin	Pin Name	Pin Description	
1	Ground (GND)		Power
2	P5.4_TXD0_OE_MAT3.3_TXD4	P5[4] – General Purpose digital Input/Output	I/O
		TXD0_OE - UART0 Transmitter Output Enable	O
		MAT3[3] – Match output for Timer 3, channel 3	O
		TXD4 – UART4 Transmit data	O
3	P5.3_RXD4_SCL0+	P5[3] – General Purpose digital Input/Output	I/O
		RXD4- UART4 receive data	I

Pin	Pin Name	Pin Description	
		SCL0+ - I2C Clock for FM+ Operation	I/O
4	P5.2_MAT3.2_SDA0+	P5[3] – General Purpose digital Input/Output	I/O
		MAT3[2] – Match output for Timer 3, channel 2	O
		SDA0+ - I2C Data for FM+ Operation	I/O
5	P1.12_MCIDAT3_PCAP0.0	P1[12] – General Purpose digital Input/Output	I/O
		MCIDAT3 – Data line 3 for SD/MMC interface	I/O
		PCAP0[0]- Capture input for PWM0 channel 0	I
6	P1.11_MCIDAT2_PWM0.6	P1[11] – General Purpose digital Input/Output	I/O
		MCIDAT2 – Data line 2 for SD/MMC interface	I/O
		PWM0[6]-Pulse Width Modulator 0, output 6	O
7	P1.7_MCIDAT1_PWM0.5	P1[7] – General Purpose digital Input/Output	I/O
		MCIDAT1 – Data line 1 for SD/MMC interface	I/O
		PWM0[5]-Pulse Width Modulator 0, output 5	O
8	P1.6_MCIDAT0_PWM0.4	P1[6] – General Purpose digital Input/Output	I/O
		MCIDAT1 – Data line 1 for SD/MMC interface	I/O
		PWM0[4]-Pulse Width Modulator 0, output 4	O
9	P1.5_MCIPWR_PWM0.3	AD0[6]- A/D converter0, input 6	I
		P1[5] – General Purpose digital Input/Output	I/O
		MCIPWR – Power Supply Enable for external SD/MMC Power Supply	O
10	P1.3_MCICMD-PWM0.2	PWM0[3]-Pulse Width Modulator 0, output 3	O
		P1[3] – General Purpose digital Input/Output	I/O
		MCICMD – Command line for SD/MMC interface	I/O
11	P0.1_TD1_RXD3_RXD0	PWM0[2]-Pulse Width Modulator 0, output 2	O
		P0[1] – General Purpose digital Input/Output	I/O
		TD1 – Can1 transmitter output	O
12	P0.0_RD1_TXD3_TXD0	RXD3 – Receiver input for UART3	I
		RXD0 – Alternate UART0 receive data	I
		P0[0] – General Purpose digital Input/Output	I/O
13	5volts(5VO)	RD1 – Can1 receive input	I
		TXD3- Transmitter output for UART3	O
		TXD0 – alternate UART0 transmit data	O
14	Ground (GND)	5.0 Volts	Power
15	P0.13_USB2_UPLD_AD0.7 ⁽¹⁾	P0[13] – General Purpose digital Input/Output	I/O
		UPLD- USB port 2 Good Link indicator	O
		AD0[7]- A/D converter0, input 7	I
16	P0.12_USBPPWR2_AD0.6 ⁽¹⁾	P0[12] – General Purpose digital Input/Output	I/O
		AD0[6]- A/D converter0, input 6	I
17	P0.25_AD0.2_TXD3 ⁽¹⁾	P0[25] – General Purpose digital Input/Output	I/O
		AD0[2]- A/D converter0, input 2	I
		TXD3 – Transmitter output for UART3	O
18	TP_RL_Y2_P0.24_AD0.1 ⁽¹⁾	TP_RL_Y2 – Touch panel interface right side horizontal [Not Typically Supported]	
		P0[24] - General Purpose digital Input/Output	I/O
		AD0[1] – A/D converter0, input 1	I
19	TP_RL_X1_P0.23_AD0.0 ⁽¹⁾	TP_RL_X1 – Touch Panel left side horizontal [Not Typically Supported]	
		P0[23] - General Purpose digital Input/Output	I/O
		AD0[0] – A/D converter0, input 0	I
20	Ground (GND)		Power

Notes: (1) Signal may be utilized by on-board function. Consult schematic for connectivity and actual usage/availability

J2 & J6 - Expansion Connector Cable Details

The maximum length for the expansion connector cables is as follows:
 General Purpose IO, TTL, Serial, etc = 6" recommended maximum, 8" absolute maximum
 Ethernet, high-speed IO, etc = 3" recommended maximum, 4" absolute maximum

The following table provides example part numbers for the expansion cables:

Description	Mfg	Mfg PN	Digi-Key Pn
3" 20-pin 0.5mm	Molex	21020-0209	WM10226-ND
6" 20-pin 0.5mm	Molex	21020-0215	WM10218-ND
3" 50-pin 0.5mm	Molex	21020-7650	WM10231-ND
6" 50-pin 0.5mm	Molex	21020-0548	WM10223-ND

Note: These lengths are only recommendations. The actual lengths utilized depend on the expansion board circuitry, layouts and general environment of the application. Tests and validation should be conducted to ensure the functional operation and use of all third party expansion connectors.

15. Schematics

Please see the FDI website at <http://www.teamfdi.com/product-details/uezgui-1788-43wqr-ba/> for support documentation.

16. Temperature Range

UEZGUI-1788-43WQR-BA board w/o LCD: -40°C to +85°C

UEZGUI-1788-43WQR-BA with LCD: -10°C to +70°C

17. Real Time Clock Backup Time

The μEZ GUI's real time clock is backed up with a Seiko Super Capacitor to preserve the time when external power is removed. The calculated backup time is shown below.

Super Capacitor	Typical Voltage	Stop Voltage	Maximum Current	Typical Backup Time
XH414HG	3.0 V	2.0 V	1μA	18 hrs

18. ESD Warning



The UEZGUI-1788-43WQR-BA kit is shipped in a protective anti-static package. The kit must not be subjected to high electrostatic potentials. Damage may occur to the boards that will not be covered under warranty. General practice for working with static sensitive devices should be followed when working with the kit.

19. Power Requirements

Power is supplied into the mini-USB connector (P1) via the USB cable and power supply provided in the kit. The power supply provides 5VDC output at 1.2A (min) and has input voltage range of 100-240VAC with a standard U.S. 2-prong wall plug. The following typical power requirements were measured at room temperature with LPC1788 at 120MHz clock rate:

Voltage	uEZ Demo Screen	Observed Max	Maximum Allowed
5V	309 mA	330 mA	Up to 2A through power connectors

uEZ GUI USB Input Port Power Requirements:

- +5VDC \pm 5% is the input power range specification. However, since the 5VDC input has reverse diode protection, it may be necessary to provide a higher input voltage level of 5VDC input to ensure that the μEZ GUI 5VDC output level retains the specified tolerance. If the μEZ GUI input level drops to 4.75VDC, then the μEZ GUI +5VDC output level to either the expansion board or the USB host connector may be lower than 4.75VDC since the worst case drop from input to output is typically 0.25V.
- For reference on the USB output port from the μEZ GUI, the following are the specifications:
 - USB High Power Specifications are 500mA maximum, and 4.75V to 5.25V standard.
 - USB Low Power Specifications are 100mA maximum, and 4.4V to 5.25V standard.

The UEZGUI-1788-43WQR may also optionally be powered via the following connectors:

- Alternate Power/Communication Connector, J10, with a maximum of 2A, 5VDC \pm 5% input
- Expansion Connector(s) J2 and/or J6 – refer to the expansion connector section for details

The μEZ GUI is capable of providing a maximum of 300mA of 3.3V power for “external use” over the expansion connectors. If more than 300mA of 3.3V is needed for an expansion board:

- Relocate the primary 5VDC power input to the expansion board rather than on the μEZ GUI itself.
- The μEZ GUI should be powered using 5V from the expansion board over the 70 pin breakout, instead of powering the expansion board from the μEZ GUI unit.
- The expansion board should be designed with a separate 3.3V voltage regulator.
- Ensure that the 3.3V voltage rails of the μEZ GUI & expansion board are not connected together.

20. Mechanical Details

The following illustrations show the mechanical details of the UEZGUI-1788-43WQR-BA PCB.

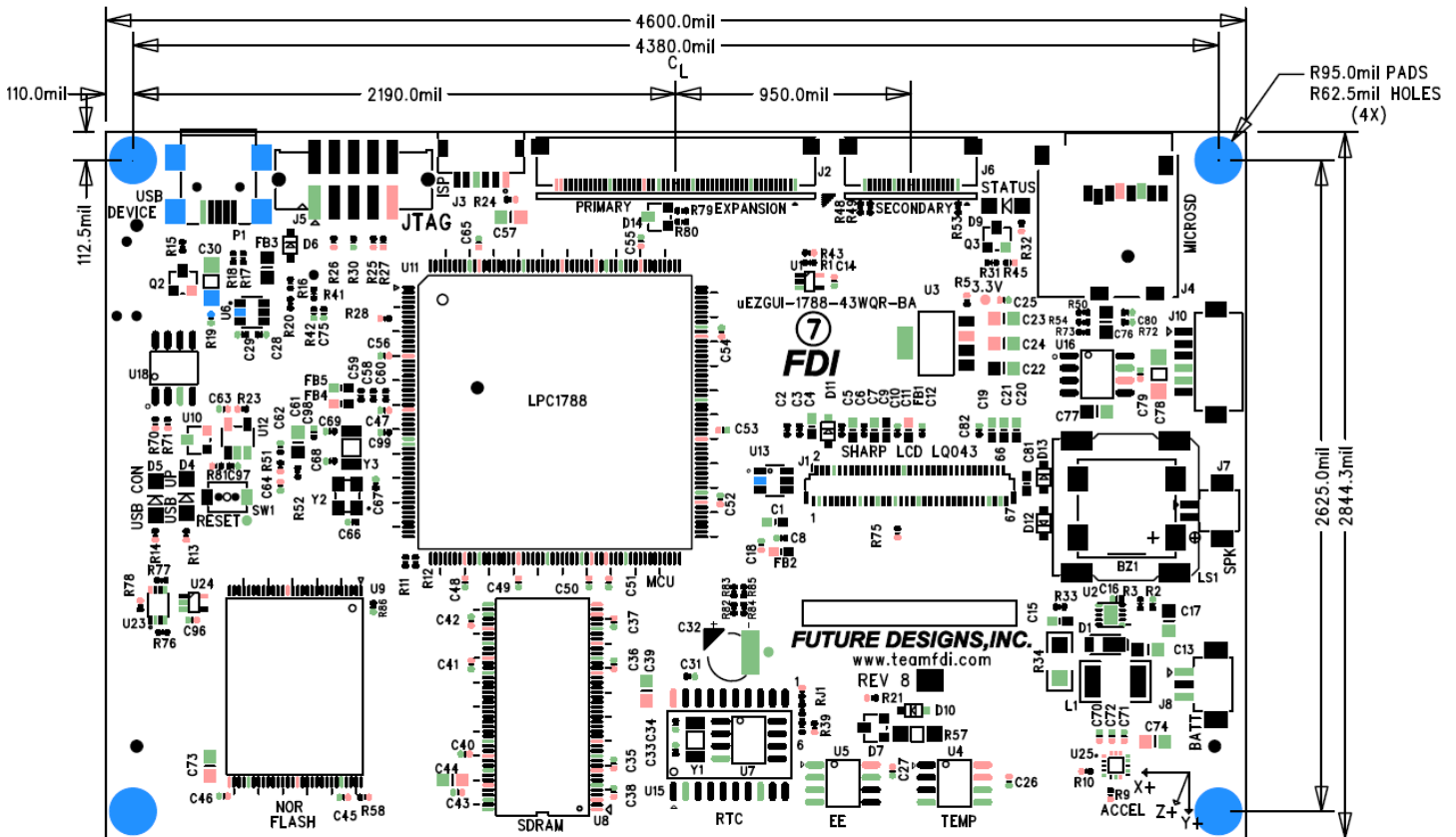

Figure 5 –Mechanical Dimensions (Component View)

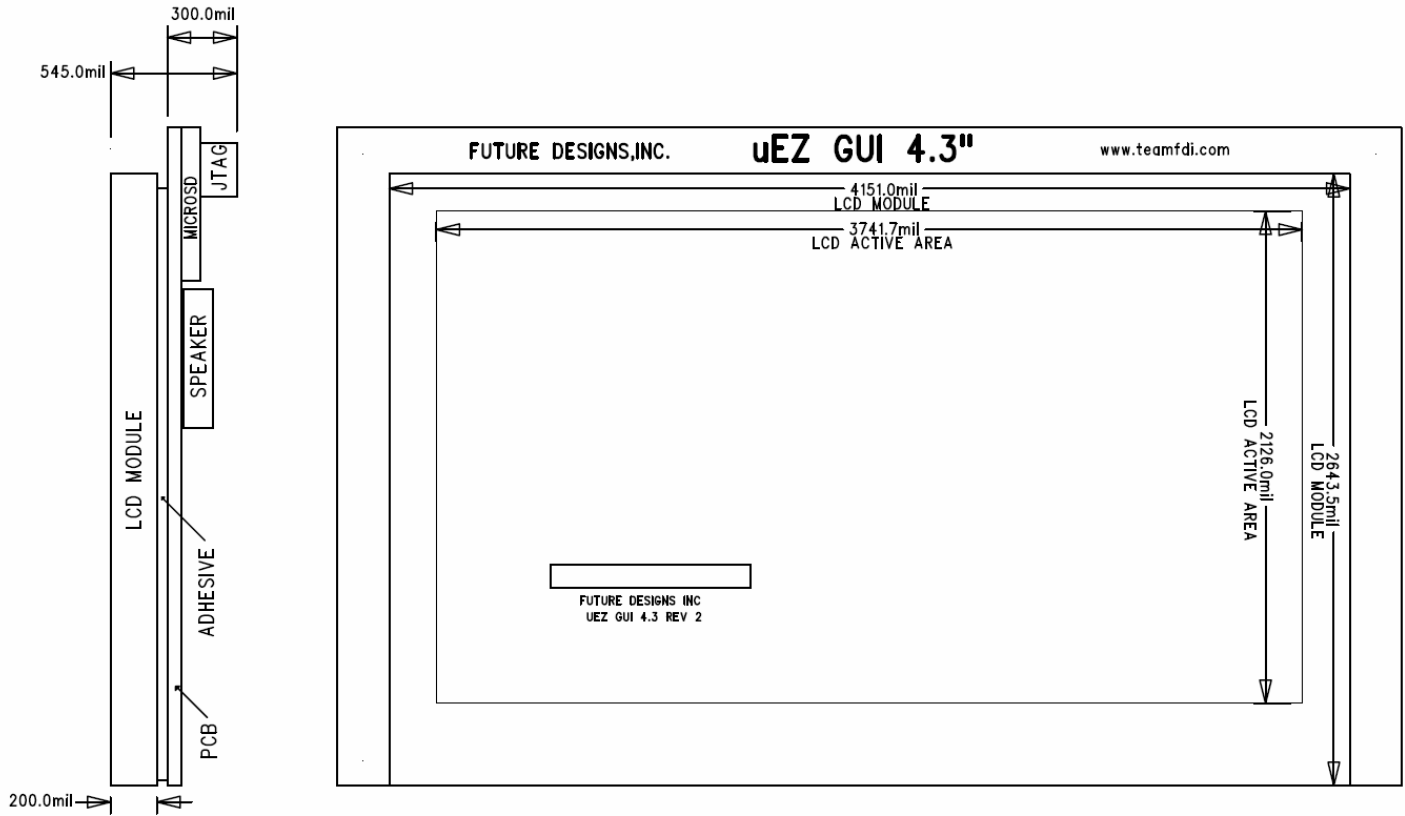

Figure 6 –Mechanical Dimensions (LCD Module View and Side View)

Note: Due to the lack of touch screen overlay, the UEZGUI-1788-WQT overall thickness is actually 543.9mm

21. Updating to UEZGUI-1788-43WQR-BA from UEZGUI-XXXX-43WQS-BA

The UEZGUI-1788-43WQR-BA has a new Sharp display that is thinner than the one found on the UEZGUI-XXXX-43WQS model. Here is a stack up comparison between the two units.

Note: Due to the lack of touch screen overlay, the UEZGUI-1788-WQT overall thickness is actually 543.9mm

Mounting Comparison between the old uEZGUI-43WQS, and the new uEZGUI-43WQR

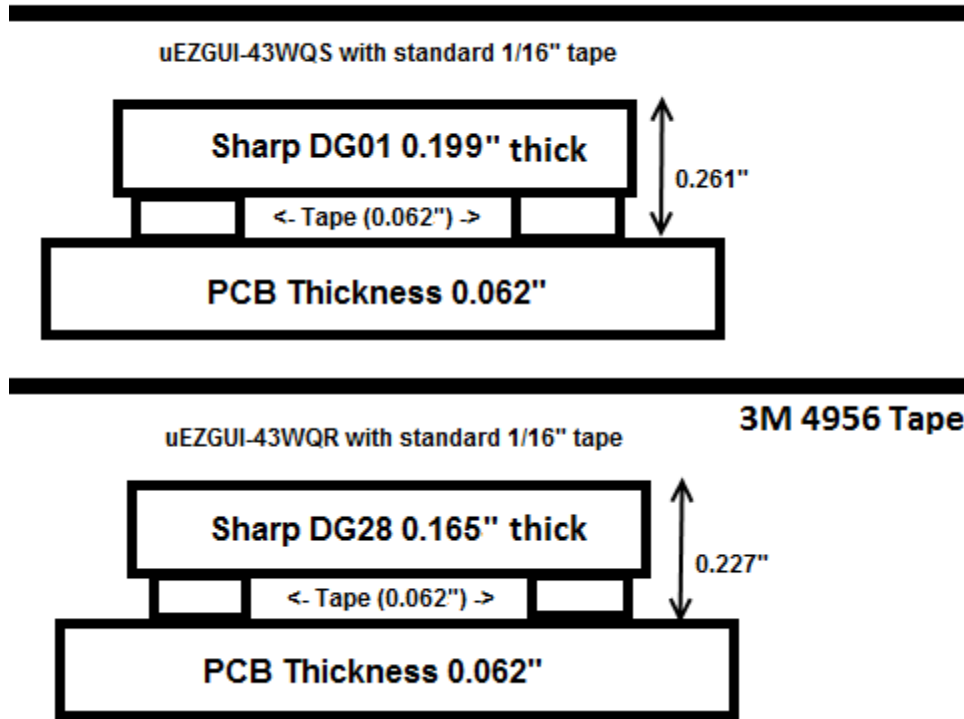

Figure 5 – UEZGUI-43WQN-BA vs. 43WQR-BA Stack-up Comparison