



LED Display Product Data Sheet LTC-4627JS

Spec No.: DS30-2000-186

Effective Date: 01/15/2010

Revision: A

LITE-ON DCC

RELEASE

BNS-OD-FC001/A4

FEATURES

- * 0.4inch (10.0mm) DIGIT HEIGHT.
- * CONTINUOUS UNIFORM SEGMENTS.
- * LOW POWER REQUIREMENT.
- * EXCELLENT CHARACTERS APPEARANCE.
- * HIGH BRIGHTNESS & HIGH CONTRAST.
- * WIDE VIEWING ANGLE.
- * SOLID STATE RELIABILITY.
- * CATEGORIZED FOR LUMINOUS INTENSITY.

DESCRIPTION

The LTC-4627JS is a 0.4 inch (10.0 mm) digit height quadruple digit seven-segment display. This device utilizes AlInGaP yellow LED chips, which are made from AlInGaP on a non-transparent GaAs substrate, and has a gray face and white segments.

DEVICE

PART NO.	DESCRIPTION
AlInGaP Yellow	Multiplex Common Anode
LTC-4627JS	Rt. Hand Decimal

PACKAGE DIMENSIONS

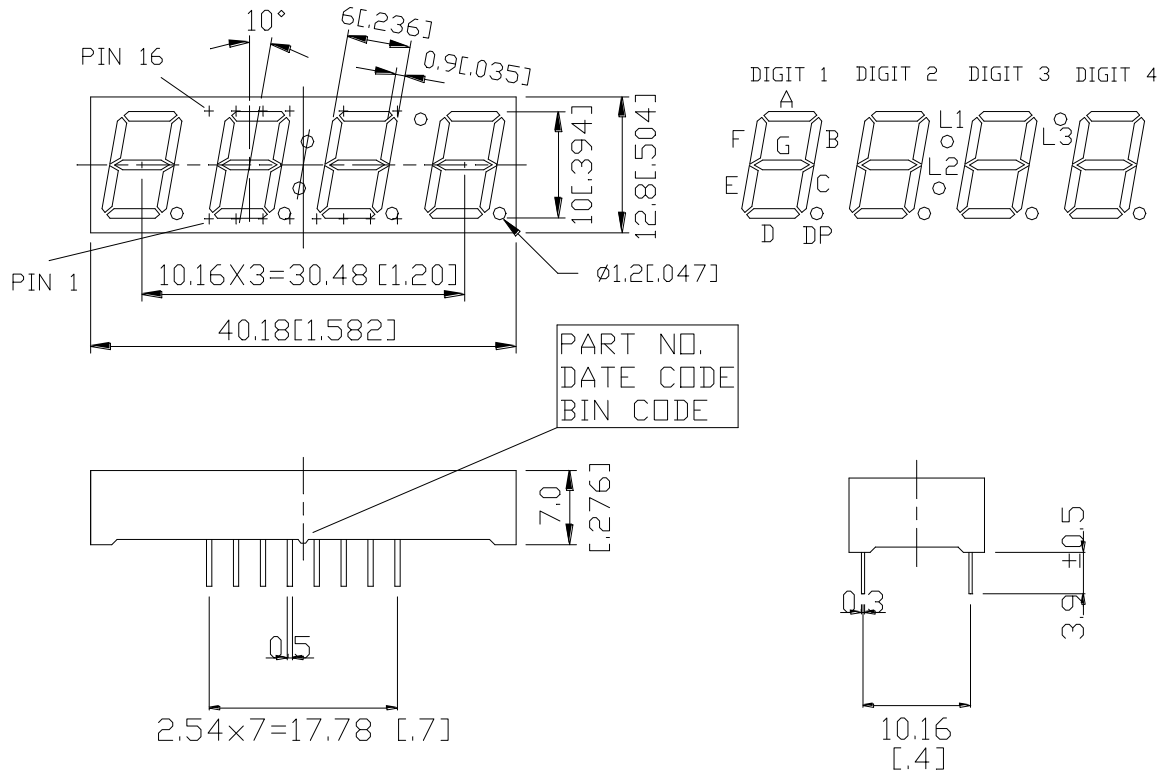

NOTES: All dimensions are in millimeters. Tolerances are ± 0.25 mm (0.01") unless otherwise noted.

INTERNAL CIRCUIT DIAGRAM

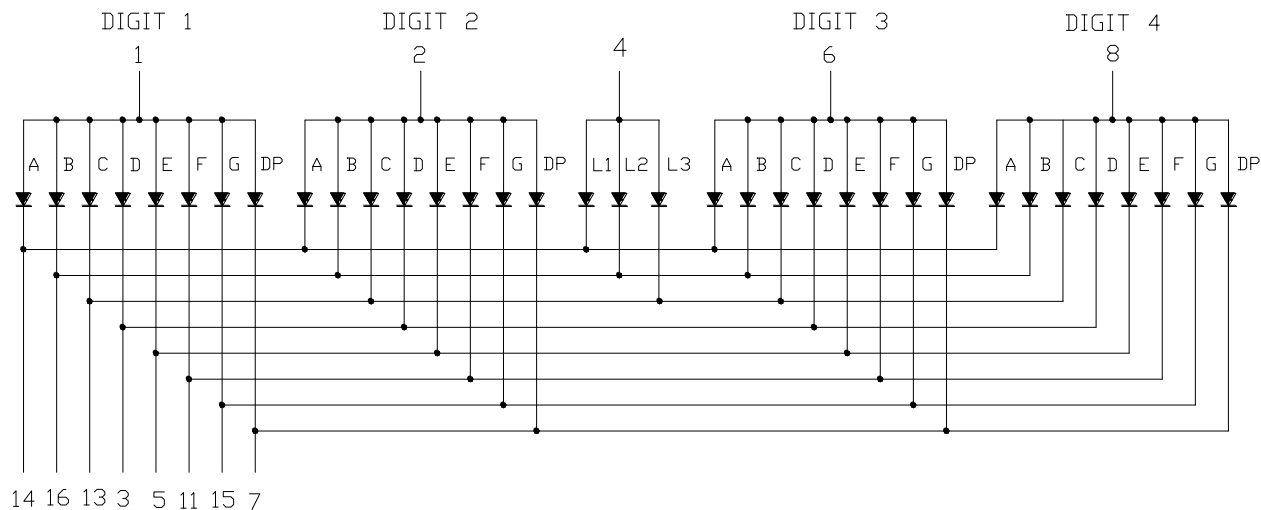

PIN CONNECTION

NO	CONNECTION
1	COMMON ANODE DIGIT 1
2	COMMON ANODE DIGIT 2
3	CATHODE D
4	COMMON ANODE L1,L2,L3
5	CATHODE E
6	COMMON ANODE DIGIT 3
7	CATHODE DP
8	COMMON ANODE DIGIT 4
9	NO CONNECTION
10	NO PIN
11	CATHODE F
12	NO PIN
13	CATHODE C,L3
14	CATHODE A,L1
15	CATHODE G
16	CATHODE B,L2

ABSOLUTE MAXIMUM RATING AT Ta=25°C

PARAMETER	MAXIMUM RATING	UNIT
Power Dissipation Per Segment	40	mW
Peak Forward Current Per Segment (1/10 Duty Cycle, 0.1ms Pulse Width)	60	mA
Continuous Forward Current Per Segment	25	mA
Derating Linear From 25°C Per Segment	0.33	mA/°C
Reverse Voltage Per Segment	5	V
Operating Temperature Range	-35°C to +85°C	
Storage Temperature Range	-35°C to +85°C	
Solder Temperature: max 260°C for max 3sec at 1.6mm below seating plane.		

ELECTRICAL / OPTICAL CHARACTERISTICS AT Ta=25°C

PARAMETER	SYMBOL	MIN.	TYP.	MAX.	UNIT	TEST CONDITION
Average Luminous Intensity	I _v	200	650		μcd	I _F =1mA
Peak Emission Wavelength	λ _p		588		nm	I _F =20mA
Spectral Line Half-Width	Δλ		15		nm	I _F =20mA
Dominant Wavelength	λ _d		587		nm	I _F =20mA
Forward Voltage Per Segment	V _F		2.05	2.6	V	I _F =20mA
Reverse Current Per Segment	I _R			100	μA	V _R =5V
Luminous Intensity Matching Ratio	I _v -m			2:1		I _F =1mA

Note: Luminous intensity is measured with a light sensor and filter combination that approximates the CIE (Commision Internationale De L'Eclairage) eye-response curve.

TYPICAL ELECTRICAL / OPTICAL CHARACTERISTIC CURVES

(25°C Ambient Temperature Unless Otherwise Noted)

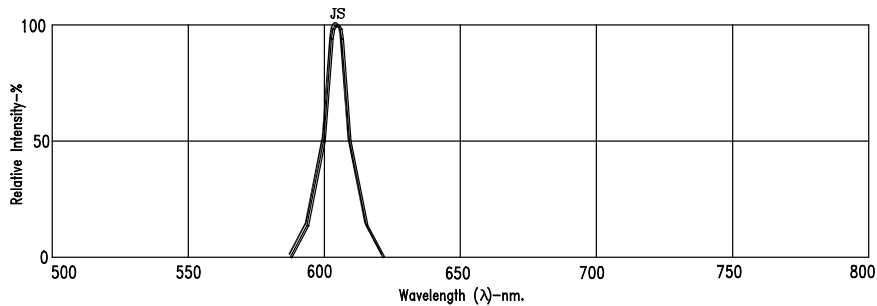

Fig1. RELATIVE INTENSITY VS. WAVELENGTH

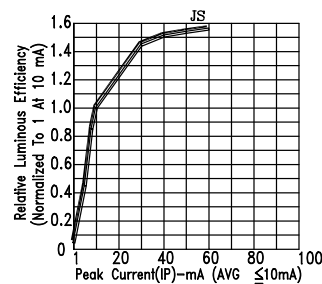

Fig2. RELATIVE LUMINOUS EFFICIENCY (LUMINOUS INTENSITY PER UNIT CURRENT) VS. PEAK CURRENT

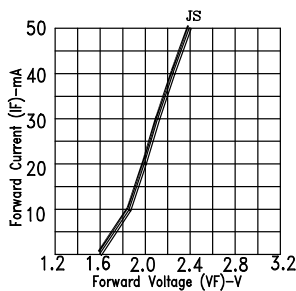

Fig3. FORWARD CURRENT VS. FORWARD VOLTAGE

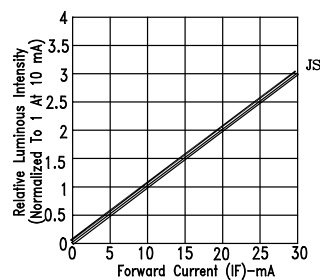

Fig4. RELATIVE LUMINOUS INTENSITY VS. FORWARD CURRENT

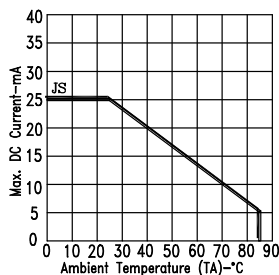

Fig5. MAX. ALLOWABLE DC CURRENT VS. AMBIENT TEMPERATURE.

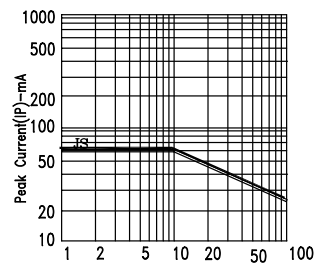

Fig6. MAX. PEAK CURRENT VS. DUTY CYCLE % (REFRESH RATE 1KHz)