

7SE001PS  
( 'ON 0NIMVHO )台要理図

版数 REV.	年月日 DATE	DCN NO.	変更内容 DESCRIPTION	製図 DR.	担当 CHK.	査閲 APPD.	承認 APPD.
2	13.Jul.2009	068246	誤記訂正		N.UCHIYAMA		y.Mizusawa

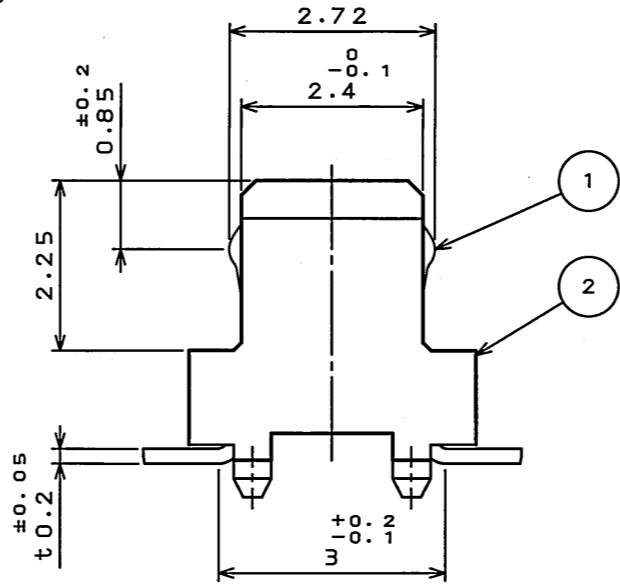
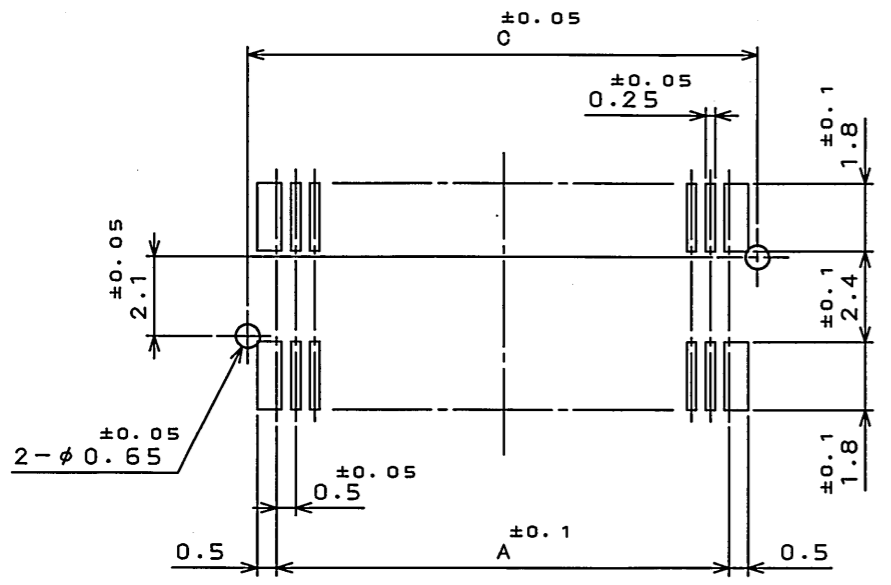
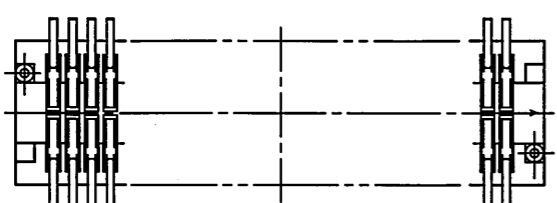
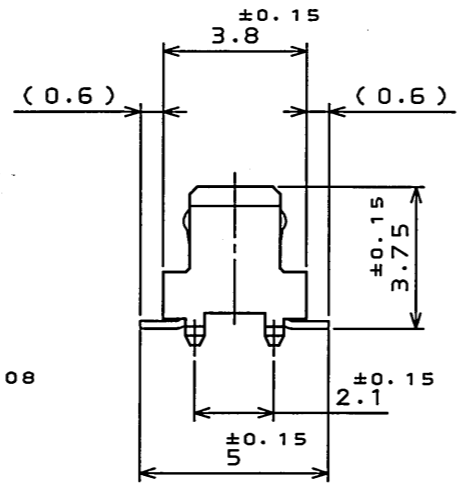
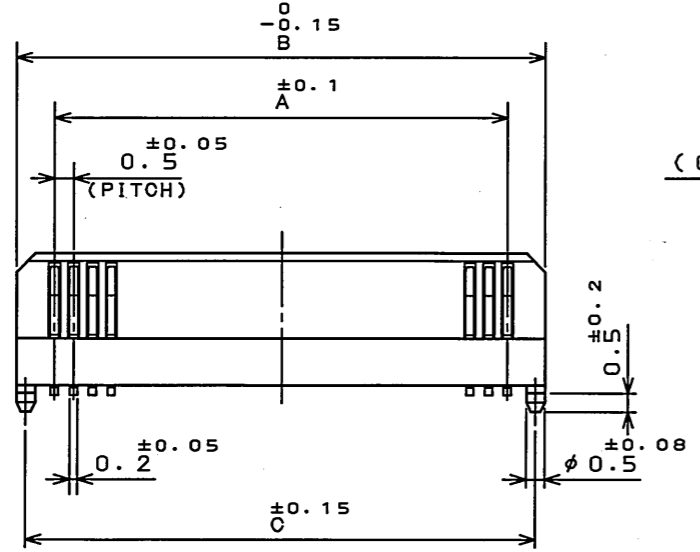
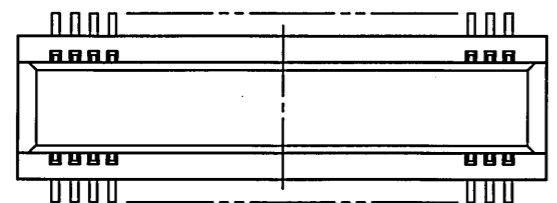

(SCALE 10:1)

TABLE 1

No. OF CONTACT(N)	A	B	C
30	7.0	9.0	8.5
40	9.5	11.5	11.0
50	12.0	14.0	13.5
60	14.5	16.5	16.0
80	19.5 $\Delta$	21.5	21.0
120	29.5	31.5	31.0
160	39.5	41.5	41.0

TABLE 2

FINISH	CONTACT AREA	TERMINAL AREA
N 1	GOLD(0.1 $\mu$ m MIN) OVER NICKEL	GOLD FLASH OVER NICKEL

NOTE 1. COPLANARITY IS AS PER APPLICABLE SPECIFICATION.

注1. 端子の振れ規定は適用仕様書による。

2	INSULATOR	1	GLASS FILLED LCP	COLOR: BLACK
1	CONTACT	TABLE 1	PHOSHPHOR BRONZE	TABLE 2
符号 NO.	名称 DESCRIPTION	個数 QTY.	材料 MATERIAL	仕上 FINISH
仕様書(SPECIFICATION)	第1版(ORIGINAL DATE)	4.Dec.2003	尺度(SCALE)	5:1
JACS-1385-*	製図 DR.	M.TANAKA	シリーズ(SERIES)	WR
公差(GENERAL TOLERANCE)	担当 CHK.	T.SHIODA	名称(TITLE)	WR-*SB-VFH05-N1
寸法(DIMENSION)	査閲 APPD.	K.KAWASE	日本航空電子工業株式会社 JAPAN AVIATION ELECTRONICS INDUSTRY, LTD.	図面番号(DRAWING NO.) SJ100357
角度(ANGLES)	承認 APPD.	S.KASHIWAGI	質量(MASS)	
. $\pm 0.8$	$X^\circ \pm$			版数 (REV.) 2
.X $\pm 0.4$	$XX^\circ \pm$			
.XX $\pm 0.1$				
.XXX $\pm$				

APPLICABLE P.C.B. DIMENSION(REF.)  
適合基板寸法(参考)

DOF-O-212F(05.08)

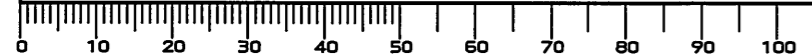

LEAD FREE この製品は鉛フリー品です

JAE CONNECTOR DIV. PROPRIETARY.  
COPYRIGHT (C) 2003, JAPAN AVIATION ELECTRONICS INDUSTRY, LTD.