

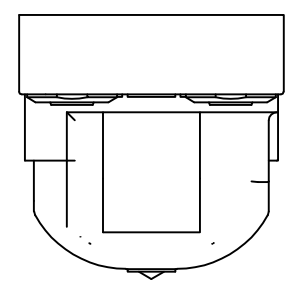

THIS DRAWING IS UNPUBLISHED.      RELEASED FOR PUBLICATION  
 © COPYRIGHT - By -      ALL RIGHTS RESERVED.

LOC	DIST	REVISIONS			
P	LTR	DESCRIPTION	DATE	DWN	APVD
	A	INITIAL RELEASE	16JAN2014	GSK	BvH

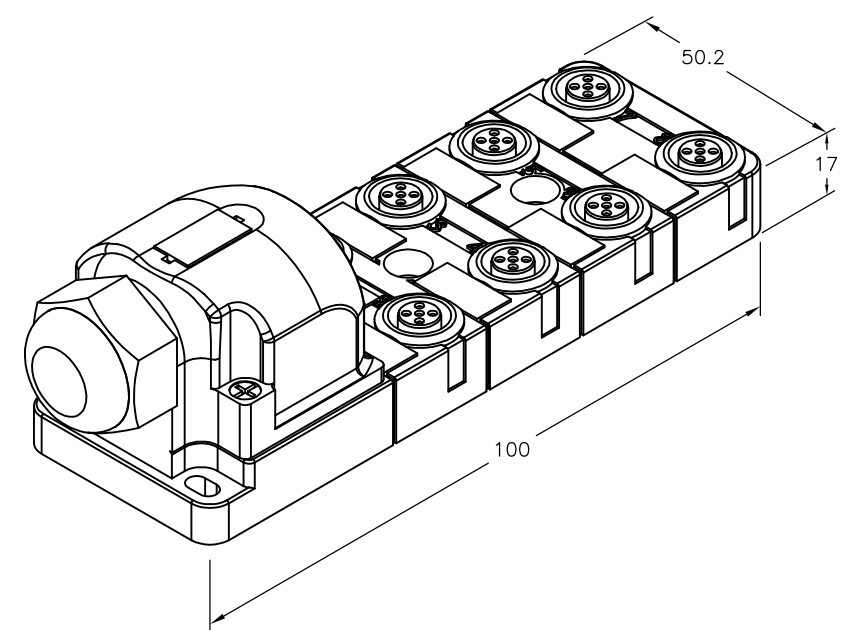
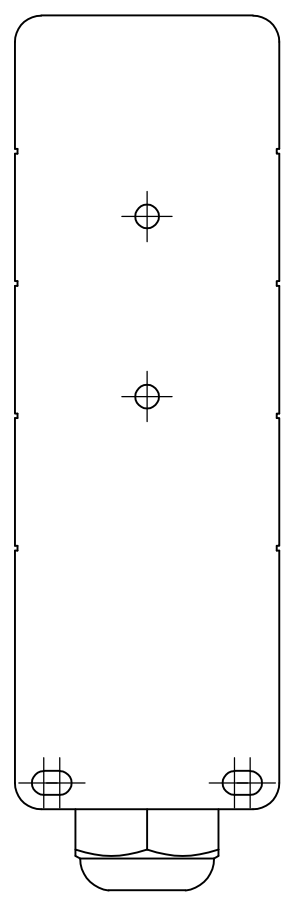
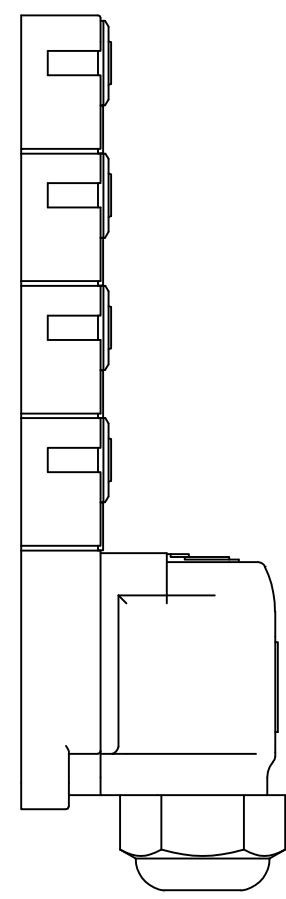
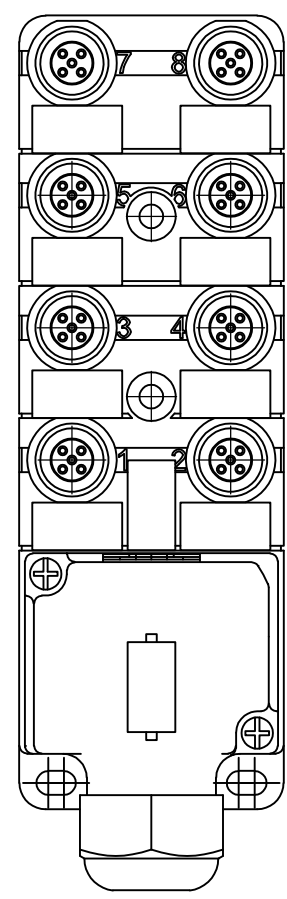
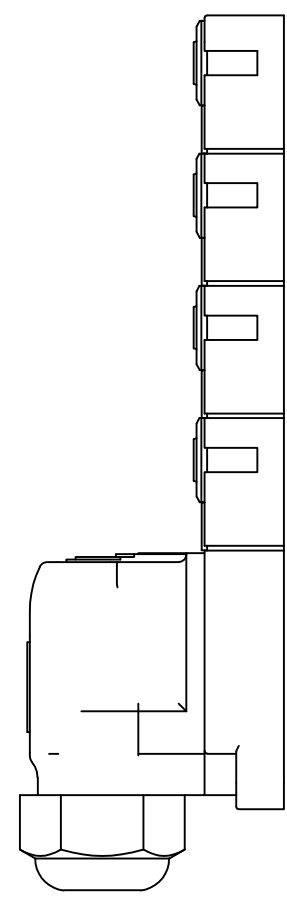
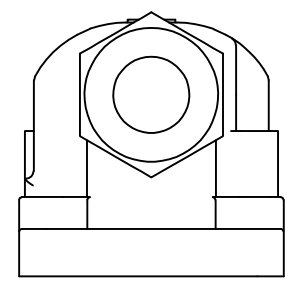

Without Homerun Cable	2273152-1
DESCRIPTION	TE PN

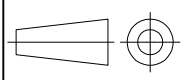
THIS DRAWING IS A CONTROLLED DOCUMENT.		DWN 16JAN2014 SATHISH KUMAR .G	 TE Connectivity				
DIMENSIONS: mm 		CHK 16JAN2014 B.VELDHOVEN					
TOLERANCES UNLESS OTHERWISE SPECIFIED: 0 PLC ± - 1 PLC ± - 2 PLC ± - 3 PLC ± - 4 PLC ± - ANGLES ± -		APVD 16JAN2014 A.VAN ZANDVOORT	NAME DISTR BOX M12 5POS 4WAY PNP				
MATERIAL -		PRODUCT SPEC -	SIZE A3	CAGE CODE 00779	DRAWING NO C-2273152	RESTRICTED TO -	
FINISH -		APPLICATION SPEC -	CUSTOMER DRAWING		SCALE NTS	SHEET 1 OF 2	REV A

THIS DRAWING IS UNPUBLISHED. RELEASED FOR PUBLICATION  
 © COPYRIGHT - By - ALL RIGHTS RESERVED.

LOC	DIST	REVISIONS			
P	LTR	DESCRIPTION	DATE	DWN	APVD
H	-	SEE SHEET 1	-	-	-

### Contact layout

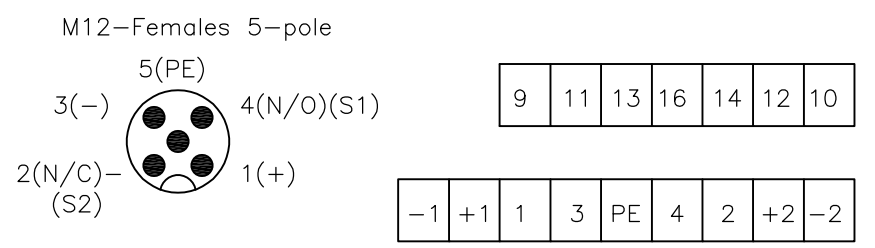

### Circuit diagram

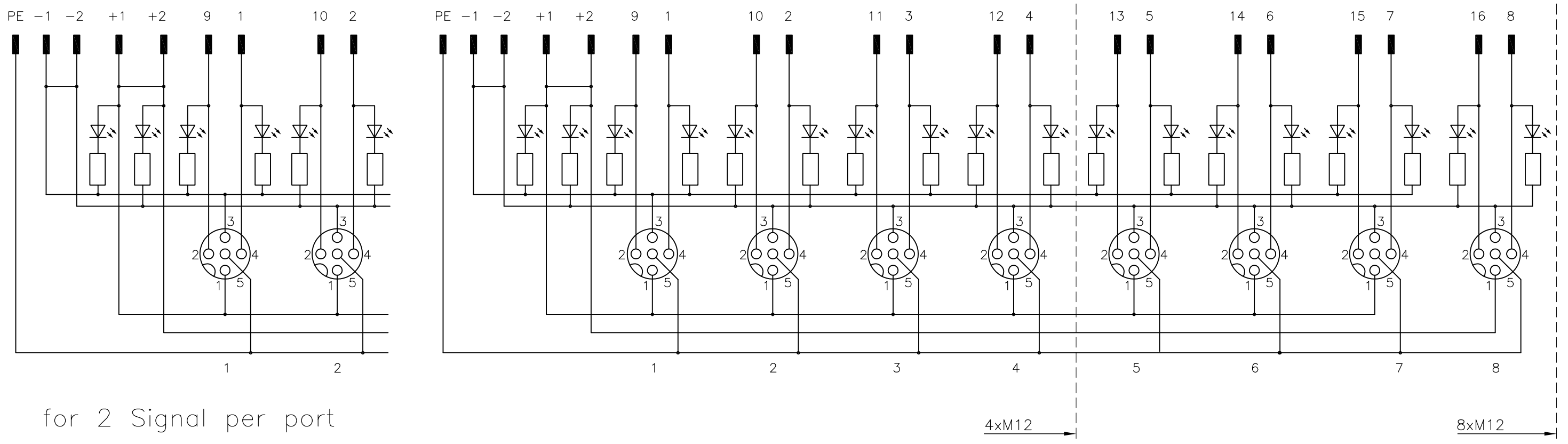

THIS DRAWING IS A CONTROLLED DOCUMENT.		DWN 16JAN2014 SATHISH KUMAR .G	TE Connectivity	
DIMENSIONS: mm		CHK 16JAN2014 B.VELDHOVEN		
TOLERANCES UNLESS OTHERWISE SPECIFIED:		APVD 16JAN2014 A.VAN ZANDVOORT	NAME DISTR BOX M12 5POS 4WAY PNP	
		PRODUCT SPEC	-	
MATERIAL		APPLICATION SPEC	-	
FINISH		WEIGHT	SIZE A3	CAGE CODE 00779
		DRAWING NO C-2273152		RESTRICTED TO
		CUSTOMER DRAWING		SCALE NTS
		SHEET 2 OF 2		REV A