

**Automotive Light Sensor**
**PRODUCTION DATA SHEET**
**DESCRIPTION**

The LX1973A is a wide dynamic range light sensor with a very low dark current that is optimized for sensing low level light signals that typically occur under dark or darkening outdoor ambient lighting. The LX1973A has been optimized for automotive systems such as headlamp brightness control or rear view mirror contrast control. Its radical (fractional exponent) response when interfaced with an 8 bit DAC can detect levels down to 0.001 lux or levels as high as 500 lux.

The spectral response of the integrated light sensor closely emulates the human eye so it ignores light such as infrared which emits energy but doesn't aid vision. This eliminates the need for an Infrared filter required with competitor's light sensors.

The LX1973A internal circuitry consists of a diode array with Microsemi's *Best Eye*™ processing that provides a nearly perfect photopic light wavelength response curve. The sensor output feeds into a wide dynamic range compression amplifier that provides accurate resolution over five decades of ambient light. The integrated dark current cancellation circuit facilitates accurate sensing of light below 0.01 lux. The current source output of the LX1973A can be gain scaled using one external resistor.

The LX1973A is internally trimmed to an initial accuracy of 5% at room temperature and a light level of 10lux. Accuracy of 10% is maintained over the full temperature range (-40 to +85°C).

**IMPORTANT:** For the most current data, consult MICROSEMI's website: <http://www.microsemi.com>  
Protected By US Patents: 6,787,757; Patents Pending

**KEY FEATURES**

- Nearly Perfect *Best Eye*™ Human Eye Spectral Response
- 25C Dark Current <0.005 lux
- 5 Decades Compressed Output
- 10% Accuracy Over Temperature
- Scalable Output Voltage
- No Optical Filters Needed

**APPLICATIONS**

- Auto headlamp control
- Auto mirror contrast control

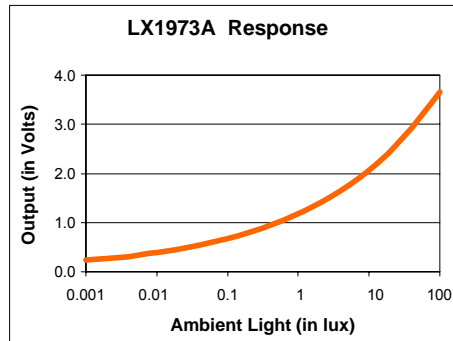
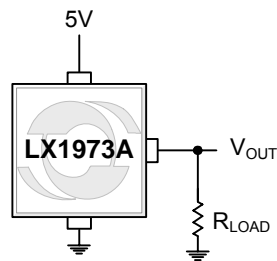
**PRODUCT HIGHLIGHT**

**PACKAGE ORDER INFO**

T <sub>A</sub> (°C)	<b>DR</b>	Plastic MSOP Reversed Form 8-Pin	<b>DU</b>	Plastic MSOP 8-pin
	-40 to 85		RoHS Compliant / Pb-free <b>LX1973AIDR</b>	

Note: Available in Tape & Reel. Append the letters "TR" to the part number. (i.e. LX1973AIDU-TR)

**ABSOLUTE MAXIMUM RATINGS**

$V_{DD}$ .....	-0.3 to 6 $V_{DC}$
SNK/SRC (Output Compliance Voltage).....	-0.3 to $V_{DD} + 0.3V_{DC}$
SNK/SRC (Maximum Output Current).....	Internally Limited
Operating Temperature Range .....	-40 to +85°C
Storage Temperature Range .....	-40 to +100°C
RoHS / Pb-free Peak Package Solder Reflow Temperature (40 seconds maximum exposure).....	260° (+0, -5)

Notes: Exceeding these ratings could cause damage to the device. All voltages are with respect to Ground. Currents are positive into, negative out of specified terminal.

**THERMAL DATA**
**DR Plastic MSOP 8-Pin Reverse Form**

THERMAL RESISTANCE-JUNCTION TO CASE, $\theta_{JC}$	<b>39°C/W</b>
THERMAL RESISTANCE-JUNCTION TO AMBIENT, $\theta_{JA}$	<b>206°C/W</b>

**DU Plastic MSOP 8-Pin**

THERMAL RESISTANCE-JUNCTION TO CASE, $\theta_{JC}$	<b>39°C/W</b>
THERMAL RESISTANCE-JUNCTION TO AMBIENT, $\theta_{JA}$	<b>206°C/W</b>

Junction Temperature Calculation:  $T_J = T_A + (P_D \times \theta_{JA})$ .

The  $\theta_{JA}$  numbers are guidelines for the thermal performance of the device/pc-board system. All of the above assume no ambient airflow.

**FUNCTIONAL PIN DESCRIPTION**

Name	Description
$V_{DD}$	Power Supply Voltage
$V_{SS}$	Ground Reference for Power and Signal Output
OUT	Current Output
BP	Internally Connected to Bonding Pad. This Pin Can Be Left Open or Connected to $V_{SS}$
NC	No Connection Pin

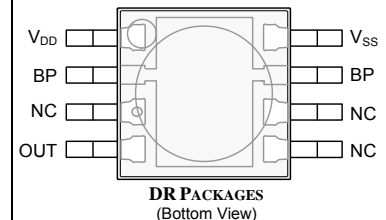
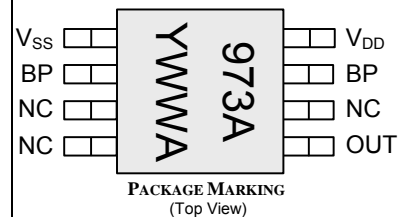
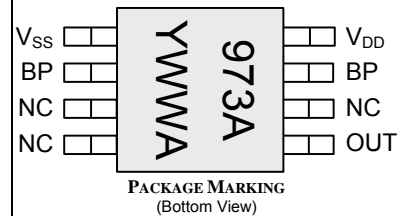
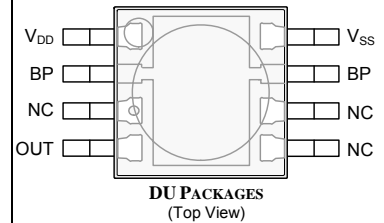
**PACKAGE PIN OUT**

RoHS / Pb-free NiPdAu Finish  
MSL 2/260°C/1 Year

**SIMPLIFIED BLOCK DIAGRAM**

Figure 1 – Simplified Block Diagram

**ELECTRICAL CHARACTERISTICS**

Unless otherwise specified, the following specifications apply over the operating ambient temperature  $-40^{\circ}\text{C} \leq T_A \leq 85^{\circ}\text{C}$  except where otherwise noted and the following test conditions: See Note 1,  $V_{DD} = 5\text{V}$ .

Parameter	Symbol	Test Conditions	LX1973A			Units
			Min	Typ	Max	
Operational Voltage	$V_{DD}$		4.5		5.5	V
Supply Current	$I_{DD}$	$E_V = 1.0 \text{ lux}$		0.2	0.25	mA
Power Supply Rejection Ratio	PSRR	$V_{RIPPLE} = 100\text{mV}_{P-P}$ , $f = 10\text{kHz}$ ; $C_{OUT} = 0.1\mu\text{F}$	30	35		dB
Peak Spectral Response	$\lambda_{PR}$			580		nm
Infrared Response	$\frac{I_{DD}(\lambda)}{I_{DD}(\lambda_{PR})}$	$E_{V(\text{white})} = 100 \text{ lux}$ , $E_{V(810\text{nm})} = 14.6\mu\text{W}/\text{cm}^2$ , Note 3	-5	1	5	%
Light to Current Gain	$G_L$	See application section for equation				
Saturation Current	$I_{SAT}$		570			$\mu\text{A}$
Radiant Sensitive Area				0.20		$\text{mm}^2$
<b>Flat Top Package (note 5)</b>						
Output Current	$I_{OUT(0.01)}$	$E_V = 0.01 \text{ lux @ } 25^{\circ}\text{C}$ , Note 1,2	32	36	40	$\mu\text{A}$
Output Current	$I_{OUT(1.0)}$	$E_V = 1.0 \text{ lux}$ , Note 1,2	103	114	125	$\mu\text{A}$
Output Current	$I_{OUT(10)}$	$E_V = 10 \text{ lux}$ , Note 1,2	183	203	223	
Output Current	$I_{OUT(100)}$	$E_V = 100 \text{ lux}$ , Note 1,2	320	360	400	$\mu\text{A}$
Dark Current (equivalent lux)	$I_{OUT(DARK)}$	$E_V = 0 \text{ lux}$ , $T_A = 20^{\circ}\text{C}$ , Note 4		450	900	$\mu\text{Lux}$
		$E_V = 0 \text{ lux}$ , $T_A = 50^{\circ}\text{C}$ , Note 4		2100	5000	
Dynamic Response Time (to 10% settling error point)	$T_{DR}$	1.0 lux to 0.01 lux		1.5	3	sec
		0.01 lux to 1.0 lux		0.2	0.5	sec
<b>Reverse Form Package (note 6)</b>						
Output Current	$I_{OUT(0.01)}$	$E_V = 0.01 \text{ lux @ } 25^{\circ}\text{C}$ , Note 1,2	32	36	40	$\mu\text{A}$
Output Current	$I_{OUT(1.0)}$	$E_V = 1.0 \text{ lux}$ , Note 1,2	105	117	128	$\mu\text{A}$
Output Current	$I_{OUT(10)}$	$E_V = 10 \text{ lux}$ , Note 1,2,	187	208	229	
Output Current	$I_{OUT(100)}$	$E_V = 100 \text{ lux}$ , Note 1,2	333	370	407	$\mu\text{A}$
Dark Current (equivalent lux)	$I_{OUT(DARK)}$	$E_V = 0 \text{ lux}$ , $T_A = 20^{\circ}\text{C}$ , Note 4		450	900	$\mu\text{Lux}$
		$E_V = 0 \text{ lux}$ , $T_A = 50^{\circ}\text{C}$ , Note 4		2100	5000	
Dynamic Response Time (to 10% settling error point)	$T_{DR}$	1.0 lux to 0.01 lux		1.5	3	sec
		0.01 lux to 1.0 lux		0.2	0.5	sec

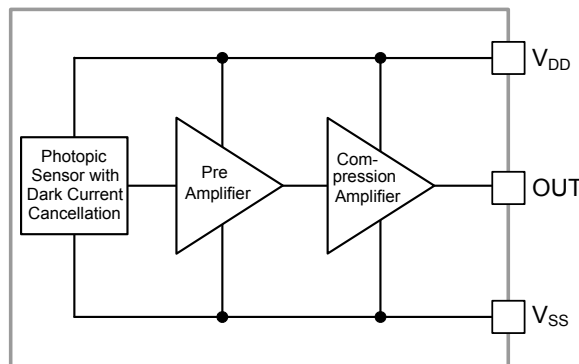
**Notes:**

- The input irradiance is supplied from a point source which is a white light emitting diode (LED); Fairchild Semiconductor part number MV8W00.
- See Figure 2.
- See Figure 3.

4. Dark Current equivalent lux at 0 lux:  $EL = \left[ \frac{I_{OUT}}{I_{REF}} \right]^4 \div (146 \times 10^{-9})$

5. For Flat Top (DU Package),  $I_{REF} = 5824\mu\text{A}$ .

6. For Reverse Form (DR Package):  $I_{REF} = 5985\mu\text{A}$

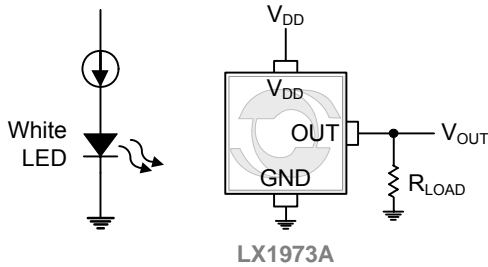
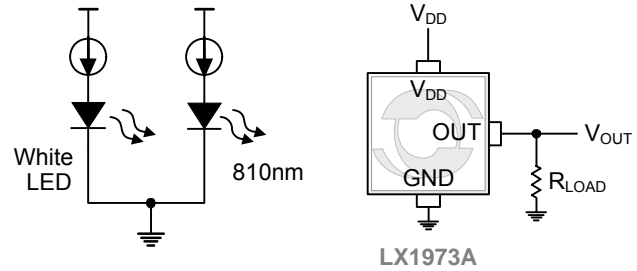
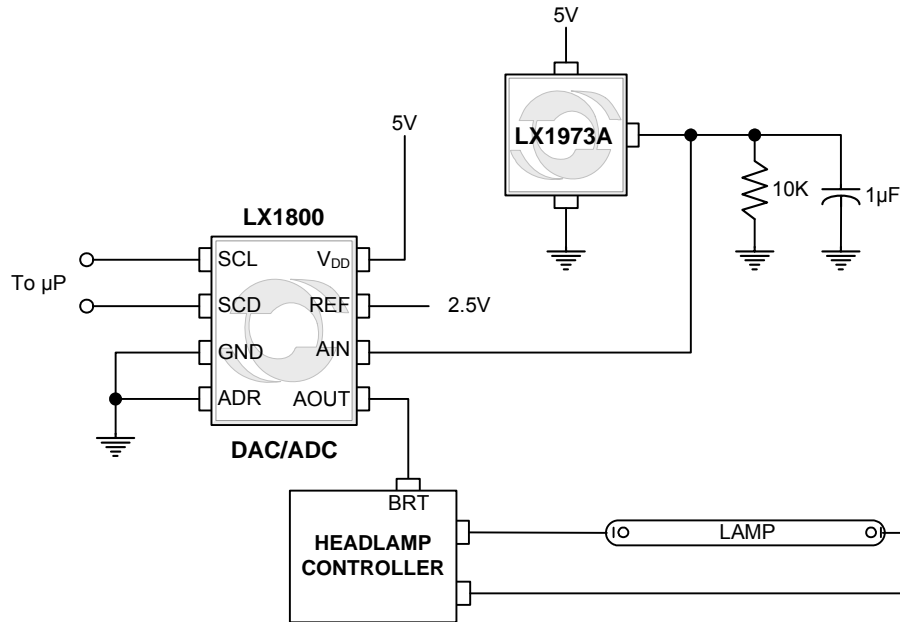
**TEST CIRCUITS**

**Figure 2 – Operational Voltage Measurement Circuit**

**Figure 3 – IR Sensitivity Measurement Circuit**
**APPLICATION CIRCUITS**

**Figure 4 – Typical Application**

**APPLICATIONS****GENERAL DESCRIPTION**

The LX1973A produces an output current that is sensitive to the level of ambient light that falls onto the photosensitive area of the IC package. The sensitivity is amplified and compressed to provide ratio metric accuracy across several decades. The sensitivity function is:

$$I_{OUT}(P) = \frac{I_{ref}}{lux^{0.25}} \times (E_{DARK} + E_{AMBIENT})^{0.25}$$

$I_{ref} = 113.8\mu A$  for the Flat Top package

$I_{ref} = 117\mu A$  for the Reverse Flat Top package

$E_{DARK}$  = dark current equivalent lux expressed in lux from a white LED point source.

$E_{AMBIENT}$  = ambient illumination expressed in lux from a white LED point source.

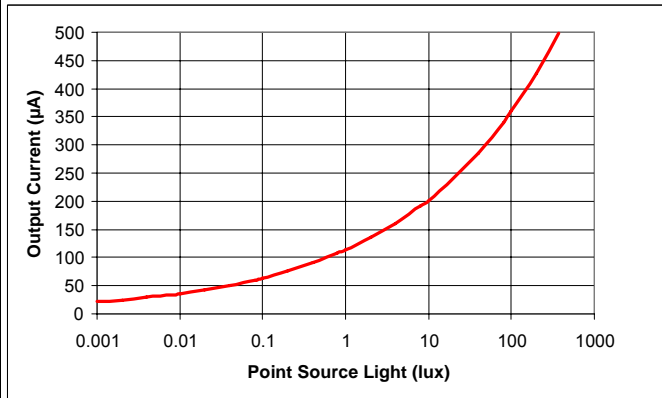
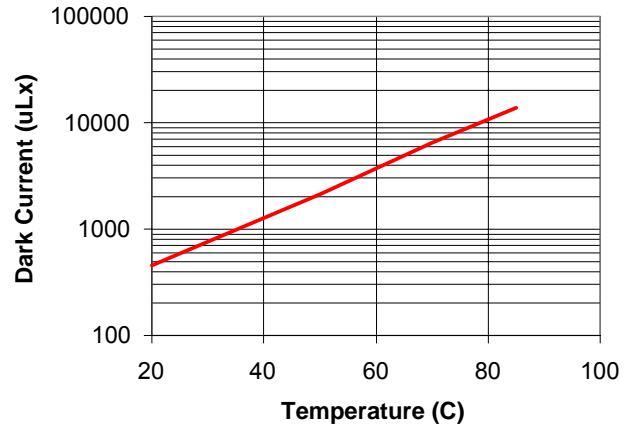
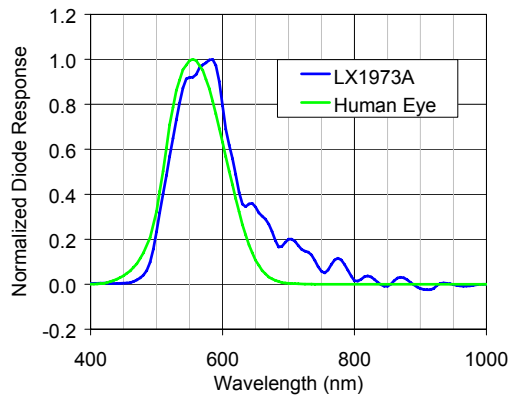
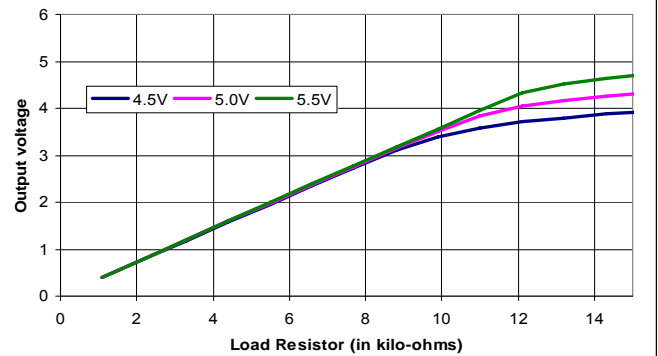
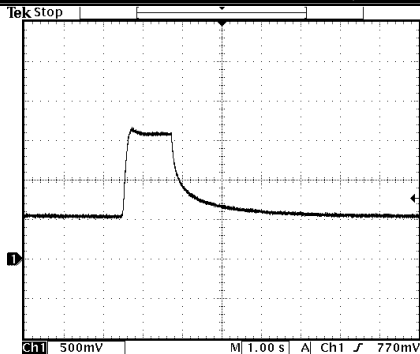
**SENSITIVITY**

**DARK CURRENT VS TEMP**

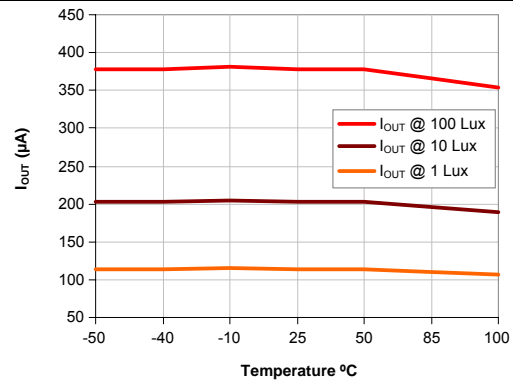
**NORMALIZED (PRE COMPRESSION)**

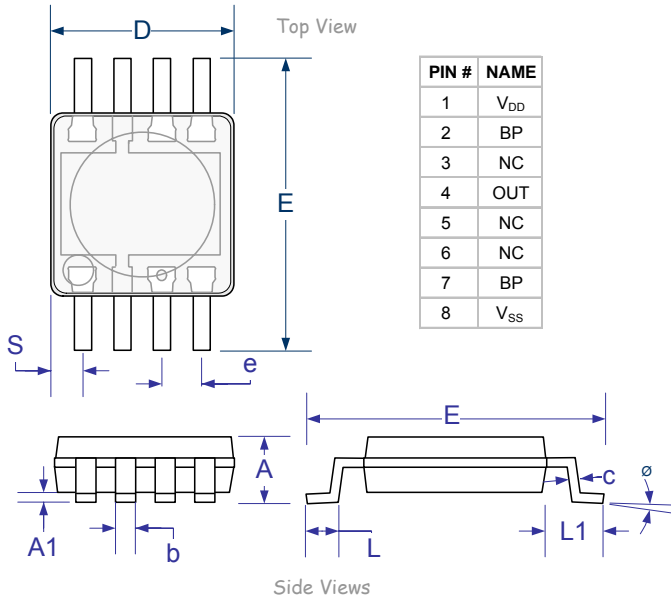
**100 LUX OUTPUT VOLTAGE (FLAT TOP)**

**I<sub>OUT</sub> STEP RESPONSE (FLAT TOP)**

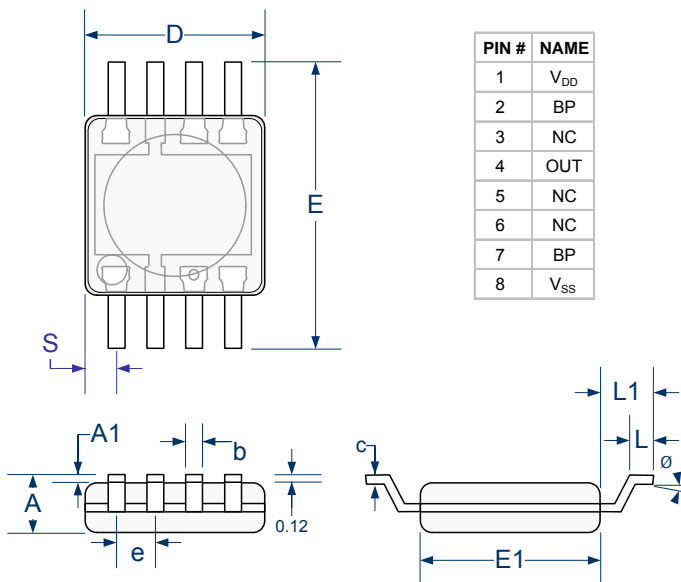
Load = 10kΩ and 0µF; Photo Step = Direct Light Input of 1 lux to 0.01 lux.

**I<sub>OUT</sub> OVER TEMP @ 100 LUX, 10 LUX, 1 LUX**

**PACKAGE DIMENSIONS**
**DU 8-Pin Miniature Shrink Outline Package (MSOP)**

Dim	MILLIMETERS		INCHES	
	MIN	MAX	MIN	MAX
A	—	1.10	—	0.043
A1	0.05	0.15	0.002	0.006
b	0.26	0.41	0.010	0.016
c	0.13	0.23	0.005	0.009
D	2.90	3.10	0.114	0.122
e	0.65 BSC		0.025 BSC	
E	4.75	5.05	0.187	0.198
E1	2.90	3.10	0.114	0.122
L	0.41	0.71	0.016	0.028
L1	0.95 BSC		0.037 BSC	
S	0.525 BSC		0.021 BSC	
Ø	3°		3°	

**DR 8-Pin Miniature Shrink Outline Package (MSOP) Reversed Form**

Dim	MILLIMETERS		INCHES	
	MIN	MAX	MIN	MAX
A	—	1.10	—	0.043
A1	0.05	0.15	0.002	0.006
b	0.26	0.41	0.010	0.016
c	0.13	0.23	0.005	0.009
D	2.90	3.10	0.114	0.122
e	0.65 BSC		0.025 BSC	
E	4.75	5.05	0.187	0.198
E1	2.90	3.10	0.114	0.122
L	0.41	0.71	0.016	0.028
L1	0.95 BSC		0.037 BSC	
S	0.525 BSC		0.021 BSC	
Ø	3°		3°	

**Note:**

Dimensions do not include mold flash or protrusions; these shall not exceed 0.155mm(.006") on any side. Lead dimension shall not include solder coverage.

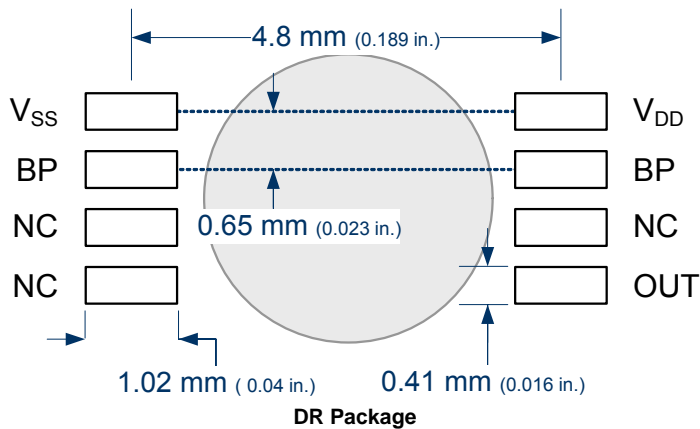
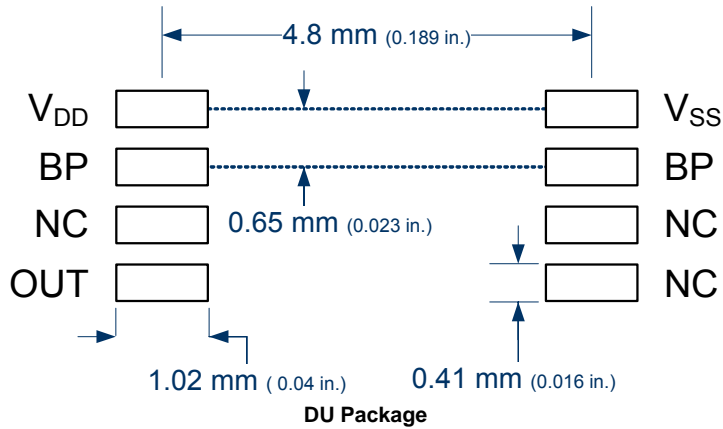
**PACKAGE INFORMATION**
**Package Land Pattern**

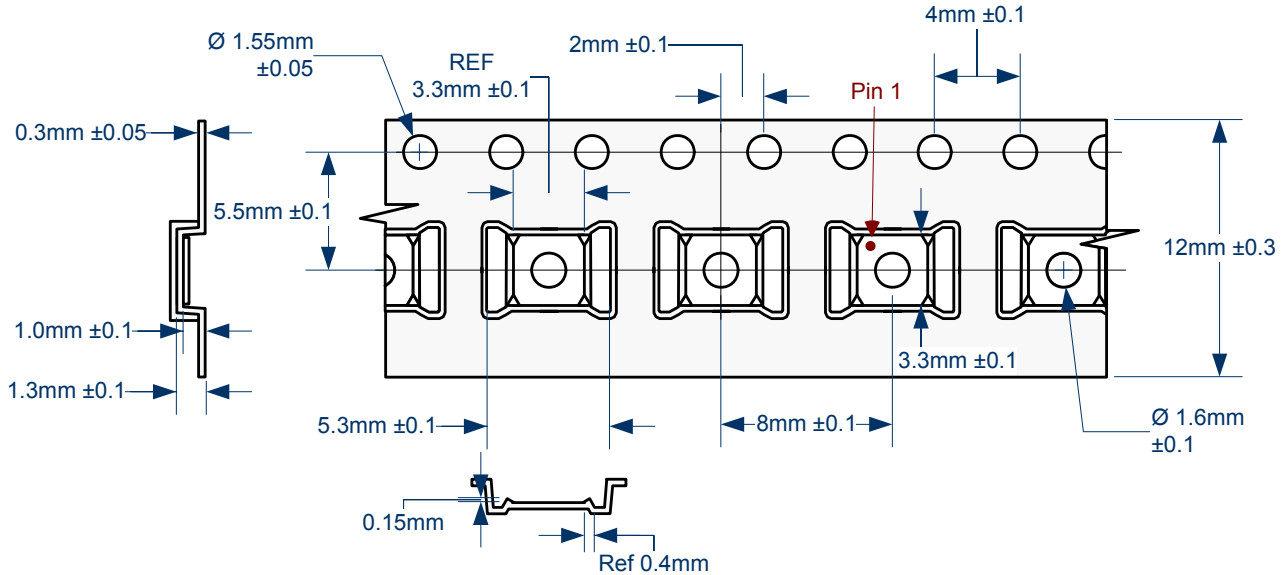

**PACKAGE TAPE AND REEL INFORMATION**

DU Package Tape and Reel Information

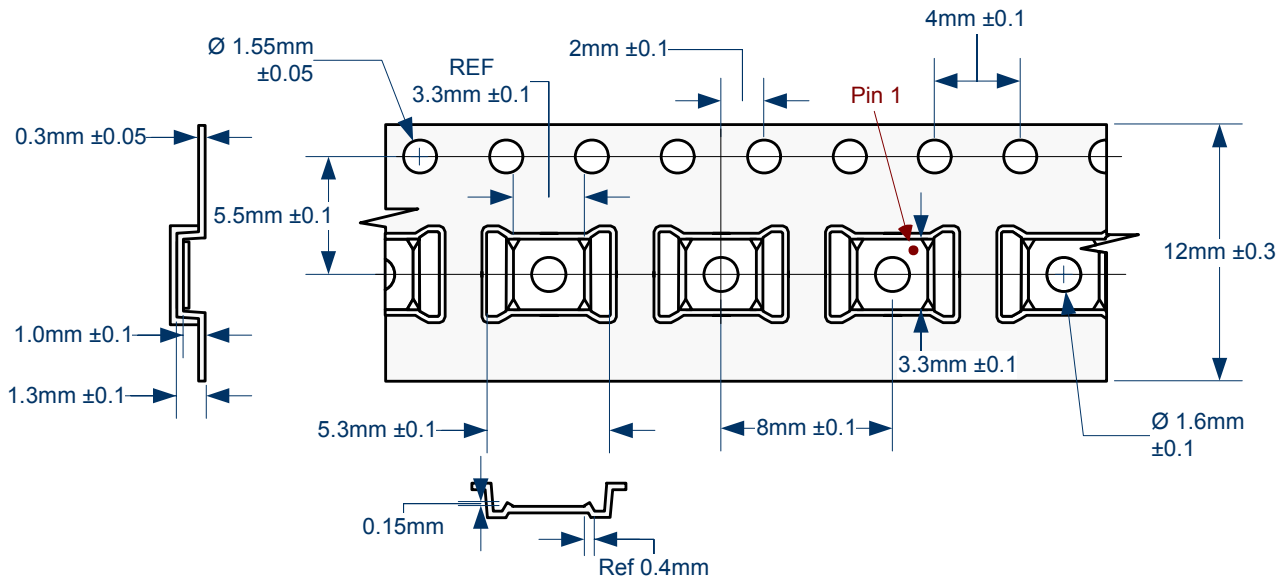

DR Package Tape and Reel Information



LX1973A

**Automotive Light Sensor**

**PRODUCTION DATA SHEET**

**NOTES**

PRODUCTION DATA – Information contained in this document is proprietary to Microsemi and is current as of publication date. This document may not be modified in any way without the express written consent of Microsemi. Product processing does not necessarily include testing of all parameters. Microsemi reserves the right to change the configuration and performance of the product and to discontinue product at any time.