

# APT35SM70B

700V, 35A, 125mΩ

## Silicon Carbide N-Channel Power MOSFET

### DESCRIPTION

Silicon carbide (SiC) power MOSFET product line from Microsemi increase your performance over silicon MOSFET and silicon IGBT solutions while lowering your total cost of ownership for high-voltage applications.

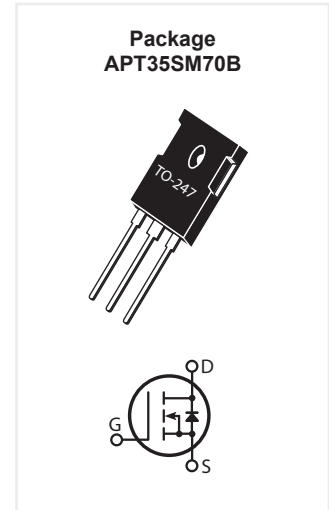

### FEATURES / TYPICAL APPLICATIONS

#### SiC MOSFET Features:

- Low on-resistance virtually independent on the ambient temperature
- Low capacitances and low gate charge
- Fast switching speed due to low internal gate resistance (ESR)
- Stable operation at high junction temperature,  $T_j(\text{max}) = +175\text{C}$
- Fast and reliable body diode
- Superior avalanche ruggedness

#### SiC MOSFET Benefits:

- High efficiency to enable lighter/compact system
- Simple to drive and easy to parallel
- Improved thermal capabilities and lower switching losses
- Eliminates the need of external Free Wheeling Diode
- Lower system cost of ownership

#### Applications:

- PV inverter, converter and industrial motor drives
- Smart grid transmission & distribution
- Induction heating, and welding
- H/EV powertrain and EV charger
- Power supply and distribution

### MAXIMUM RATINGS

Symbol	Parameter	Ratings	Unit
$V_{\text{DSS}}$	Drain Source Voltage	700	V
$I_{\text{D}}$	Continuous Drain Current @ $T_c = 25^\circ\text{C}$	35	A
	Continuous Drain Current @ $T_c = 100^\circ\text{C}$	25	
$I_{\text{DM}}$	Pulsed Drain Current <sup>①</sup>	80	
$V_{\text{GS}}$	Gate-Source Voltage	-10 to +25	V
$P_{\text{D}}$	Total Power Dissipation @ $T_c = 25^\circ\text{C}$	176	W
	Linear Derating Factor	1.18	W/°C

### THERMAL AND MECHANICAL CHARACTERISTICS

Symbol	Characteristic	Min	Typ	Max	Unit
$R_{\theta\text{JC}}$	Junction to Case Thermal Resistance		0.75	0.85	°C/W
$T_j$	Operating Junction Temperature	-55		175	°C
$T_{\text{stg}}$	Storage Junction Temperature Range	-55		150	
$T_L$	Soldering Temperature for 10 Seconds (1.6mm from case)			260	
Torque	Mounting Torque (TO-247 Package), 6-32 or M3 screw			10	in·lbf
				1.1	N·m

# APT35SM70B

## STATIC CHARACTERISTICS

Symbol	Parameter	Test Conditions	Min	Typ	Max	Unit
$V_{(BR)DSS}$	Drain-Source Breakdown Voltage	$V_{GS} = 0V, I_D = 1mA$	700			V
$R_{DS(on)}$	Drain-Source On Resistance <sup>2</sup>	$V_{GS} = 20V, I_D = 10A$		125	145	m $\Omega$
$V_{GS(th)}$	Gate-Source Threshold Voltage	$V_{GS} = V_{DS}, I_D = 1mA$	1.7	2.5		V
$\Delta V_{GS(th)}/\Delta T_J$	Threshold Voltage Temperature Coefficient			-5.5		mV/ $^{\circ}C$
$I_{DSS}$	Zero Gate Voltage Drain Current	$V_{DS} = 700V$ $V_{GS} = 0V$		$T_J = 25^{\circ}C$	100	$\mu A$
				$T_J = 150^{\circ}C$	250	
$I_{GSS}$	Gate-Source Leakage Current	$V_{GS} = +20V / -10V$			$\pm 100$	nA
ESR	Equivalent Series Resistance	$f = 1MHz, 25mV, \text{Drain Short}$		2.2		$\Omega$

$T_J = 25^{\circ}C$  unless otherwise specified

## DYNAMIC CHARACTERISTICS

Symbol	Parameter	Test Conditions	Min	Typ	Max	Unit		
$C_{iss}$	Input Capacitance	$V_{GS} = 0V, V_{DD} = 700V$ $f = 1MHz$		1035		pF		
$C_{rss}$	Reverse Transfer Capacitance		26					
$C_{oss}$	Output Capacitance		127					
$Q_g$	Total Gate Charge	$V_{GS} = 0/20V$		67		nC		
$Q_{gs}$	Gate-Source Charge	$V_{DD} = 466V$		11				
$Q_{gd}$	Gate-Drain Charge	$I_D = 10A$		19				
$t_{d(on)}$	Turn-On Delay Time	$V_{DD} = 466V$ $V_{GS} = 0/20V$ $I_D = 10A$ $R_G = 3.0 \Omega$ <sup>③</sup> $L = 115 \mu H$ $T_c = 25^{\circ}C$ Freewheeling Diode = APT10SCE65B		8		ns		
$t_r$	Current Rise Time			4				
$t_{d(off)}$	Turn-Off Delay Time			24				
$t_f$	Current Fall Time			18				
$E_{on2}$	Turn-On Switching Energy <sup>④</sup>				71		$\mu J$	
$E_{off}$	Turn-Off Switching Energy				23			
$t_{d(on)}$	Turn-On Delay Time		$V_{DD} = 466V$ $V_{GS} = 0/20V$ $I_D = 10A$ $R_G = 3.0 \Omega$ <sup>③</sup> $L = 115 \mu H$ $T_c = 150^{\circ}C$ Freewheeling Diode = APT10SCE65B		7			ns
$t_r$	Current Rise Time				4			
$t_{d(off)}$	Turn-Off Delay Time			27				
$t_f$	Current Fall Time			19				
$E_{on2}$	Turn-On Switching Energy <sup>④</sup>				67		$\mu J$	
$E_{off}$	Turn-Off Switching Energy				28			

### Source-Drain Diode Characteristics

Symbol	Parameter	Test Conditions	Min	Typ	Max	Unit
$V_{SD}$	Diode Forward Voltage	$I_{SD} = 10A, V_{GS} = 0V$		4.25		V
$t_{rr}$	Reverse Recovery Time	$I_{SD} = 10A, V_{DD} = 466V$ $di/dt = -1000A/\mu s$		35		ns
$Q_{rr}$	Reverse Recovery Charge			115		nC
$I_{rrm}$	Reverse Recovery Current			6.6		A

$T_J = 25^{\circ}C$  unless otherwise specified

- ① Repetitive Rating: Pulse width and case temperature limited by maximum junction temperature  
 ② Pulse test: Pulse Width < 380 $\mu s$ , duty cycle < 2%.  
 ③  $R_G$  is total gate resistance including internal gate driver impedance.  
 ④  $E_{on2}$  includes energy of APT10SCE65B free wheeling diode.

# APT35SM70B

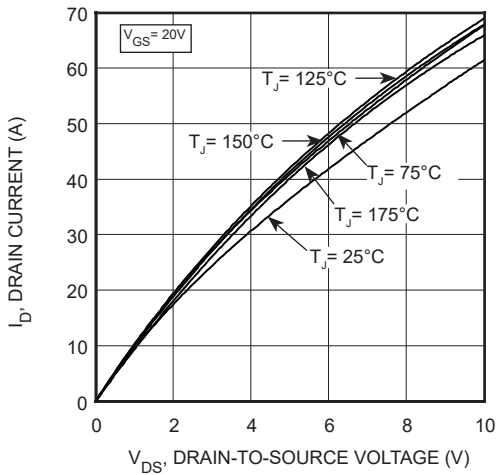

Figure 1, Output Characteristics

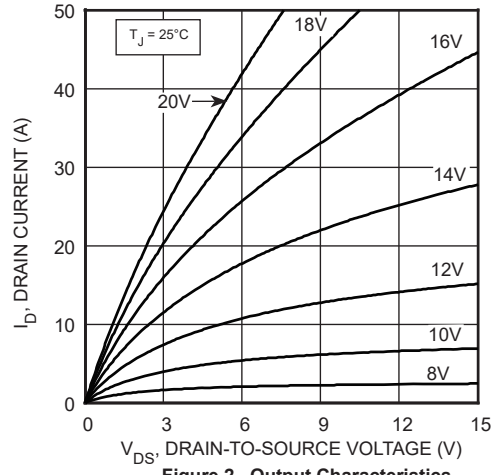

Figure 2, Output Characteristics

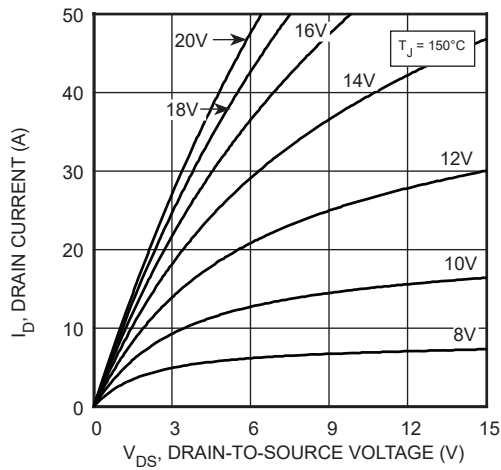

Figure 3, Output Characteristics

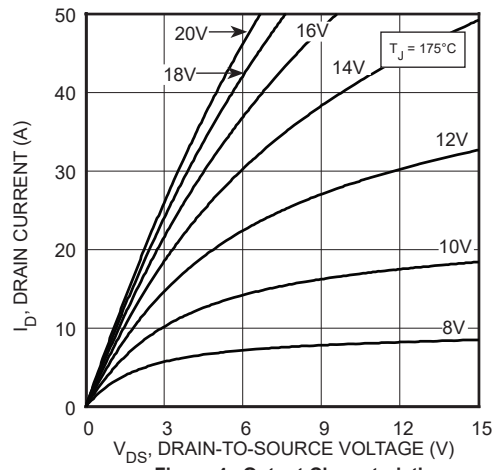

Figure 4, Output Characteristics

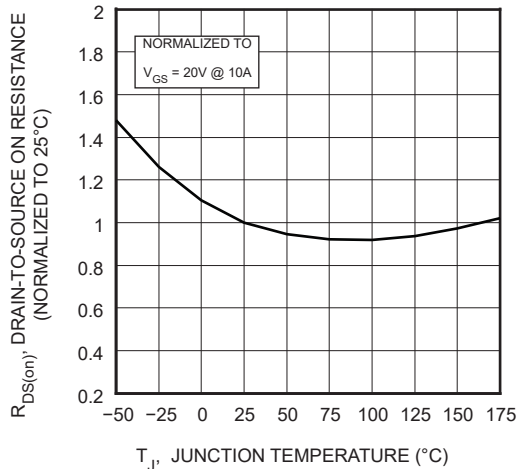

Figure 5,  $R_{DS(on)}$  vs Junction Temperature

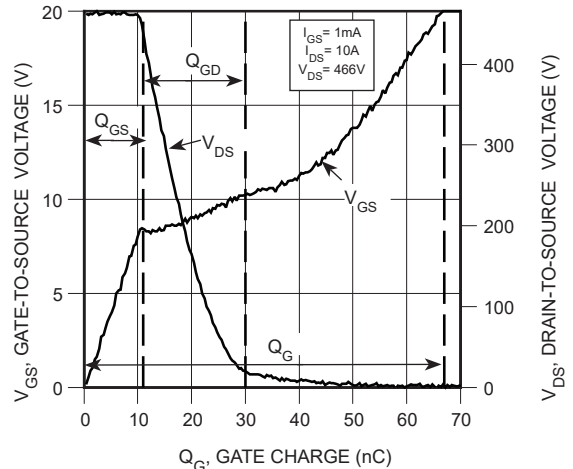

Figure 6, Gate Charge Characteristics

# APT35SM70B

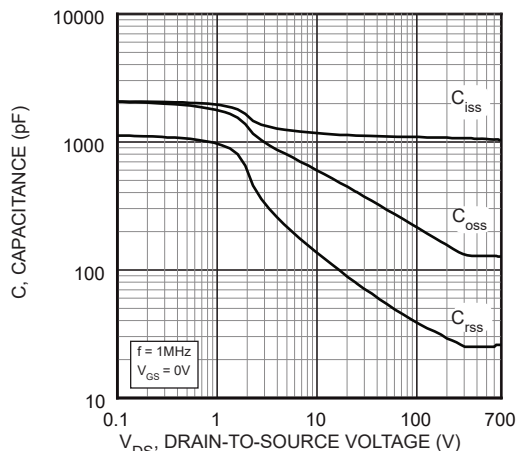

Figure 7, Capacitance vs Drain-to-Source Voltage

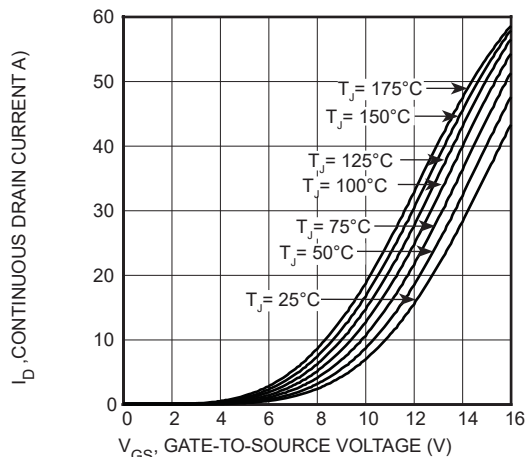

Figure 8, Output Characteristics  $I_D$  vs  $V_{GS}$  Temperature

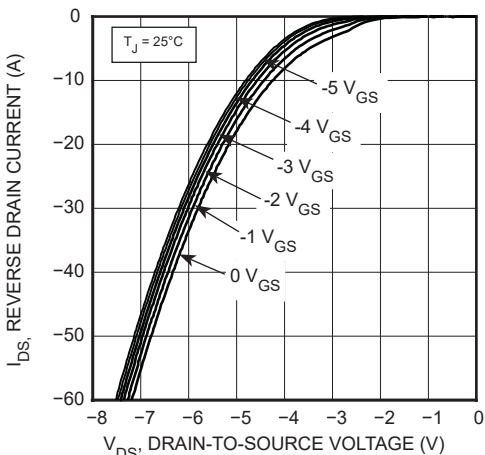

Figure 9, Reverse Drain Current vs Drain-to-Source Voltage Third Quadrant Conduction

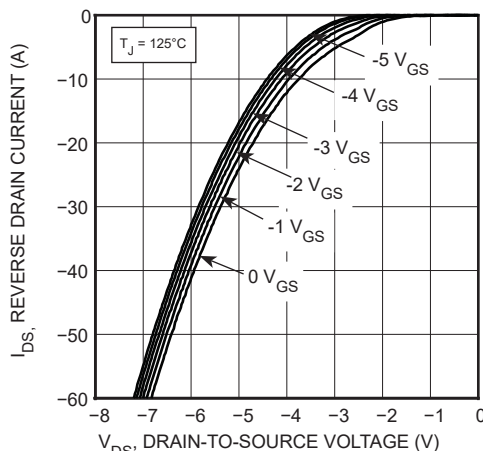

Figure 10, Reverse Drain Current vs Drain-to-Source Voltage Third Quadrant Conduction

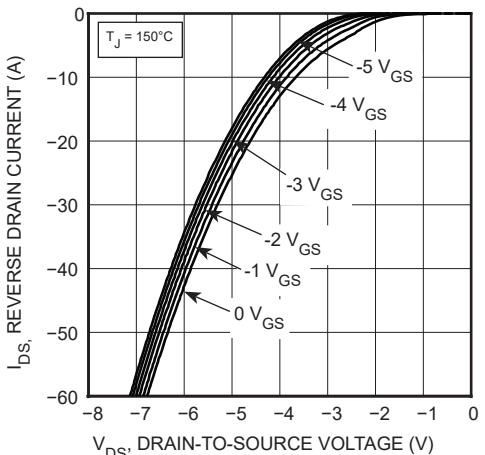

Figure 11, Reverse Drain Current vs Drain-to-Source Voltage Third Quadrant Conduction

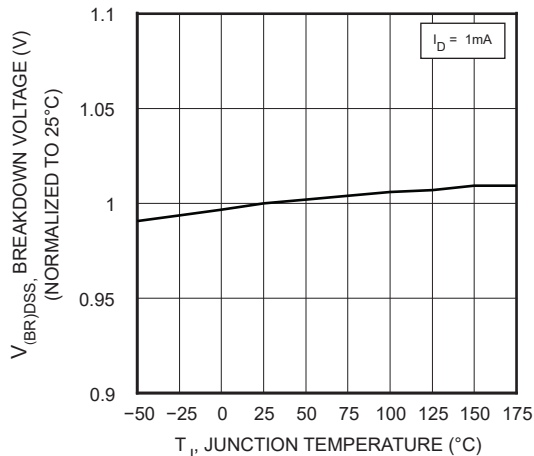

Figure 12, Breakdown Voltage vs Temperature

# APT35SM70B

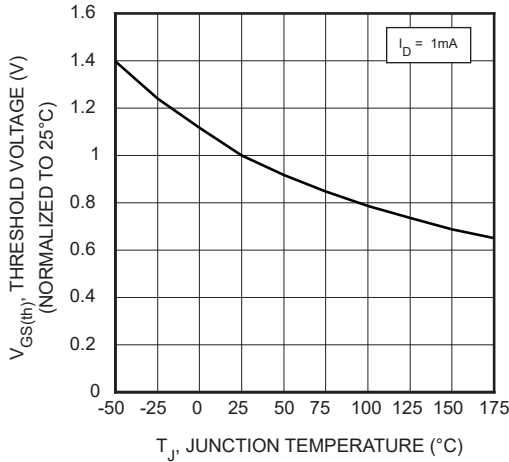

Figure 13, Threshold Voltage vs Temperature

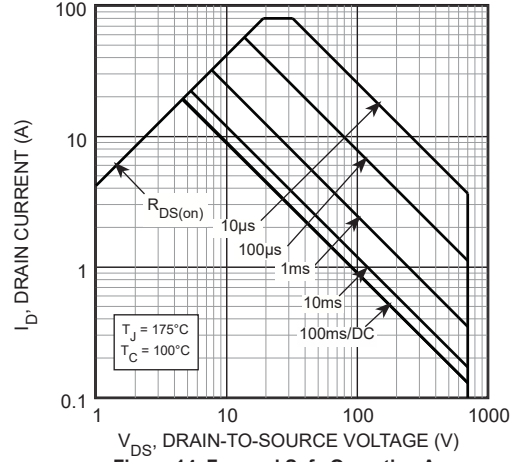

Figure 14, Forward Safe Operating Area

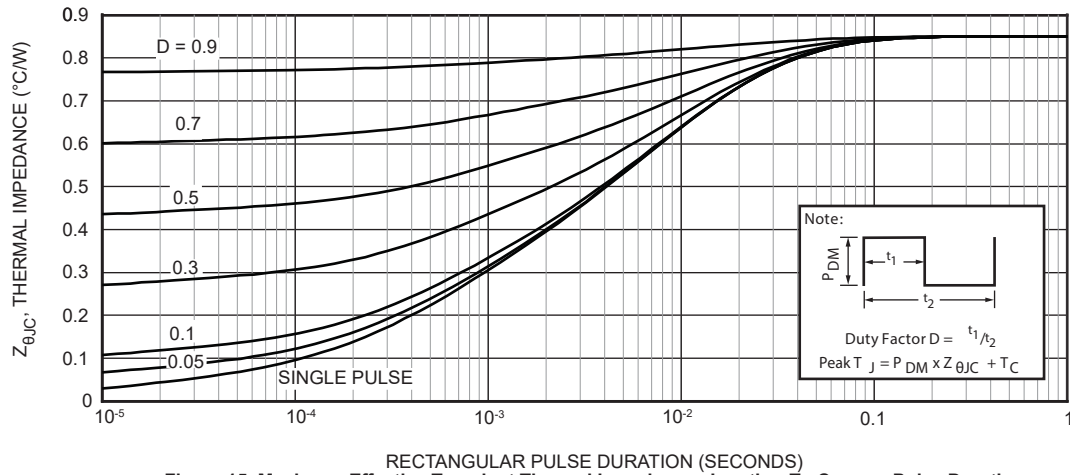
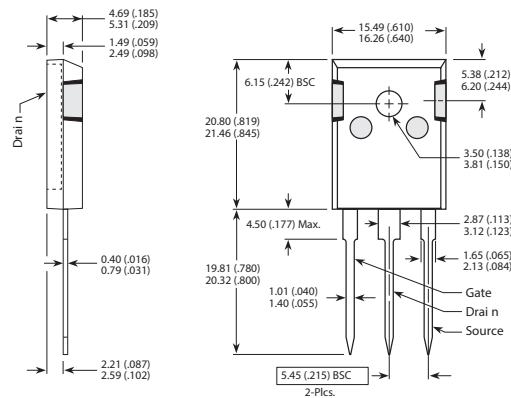

Figure 15, Maximum Effective Transient Thermal Impedance, Junction-To-Case vs Pulse Duration

## TO-247 (B) Package Outline



Dimensions in Millimeters (Inches)

Microsemi makes no warranty, representation, or guarantee regarding the information contained herein or the suitability of its products and services for any particular purpose, nor does Microsemi assume any liability whatsoever arising out of the application or use of any product or circuit. The products sold hereunder and any other products sold by Microsemi have been subject to limited testing and should not be used in conjunction with mission-critical equipment or applications. Any performance specifications are believed to be reliable but are not verified, and Buyer must conduct and complete all performance and other testing of the products, alone and together with, or installed in, any end-products. Buyer shall not rely on any data and performance specifications or parameters provided by Microsemi. It is the Buyer's responsibility to independently determine suitability of any products and to test and verify the same. The information provided by Microsemi hereunder is provided "as is, where is" and with all faults, and the entire risk associated with such information is entirely with the Buyer. Microsemi does not grant, explicitly or implicitly, to any party any patent rights, licenses, or any other IP rights, whether with regard to such information itself or anything described by such information. Information provided in this document is proprietary to Microsemi, and Microsemi reserves the right to make any changes to the information in this document or to any products and services at any time without notice.



Microsemi Corporate Headquarters  
One Enterprise, Aliso Viejo, CA 92656 USA  
Within the USA: +1 (800) 713-4113  
Outside the USA: +1 (949) 380-6100  
Sales: +1 (949) 380-6136  
Fax: +1 (949) 215-4996  
email: [sales.support@microsemi.com](mailto:sales.support@microsemi.com)  
[www.microsemi.com](http://www.microsemi.com)

Microsemi Corporation (Nasdaq: MSCC) offers a comprehensive portfolio of semiconductor and system solutions for communications, defense & security, aerospace and industrial markets. Products include high-performance and radiation-hardened analog mixed-signal integrated circuits, FPGAs, SoCs and ASICs; power management products; timing and synchronization devices and precise time solutions, setting the world's standard for time; voice processing devices; RF solutions; discrete components; security technologies and scalable anti-tamper products; Ethernet Solutions; Power-over-Ethernet ICs and midspans; as well as custom design capabilities and services. Microsemi is headquartered in Aliso Viejo, Calif., and has approximately 4,800 employees globally. Learn more at [www.microsemi.com](http://www.microsemi.com).

©2016 Microsemi Corporation. All rights reserved. Microsemi and the Microsemi logo are registered trademarks of Microsemi Corporation. All other trademarks and service marks are the property of their respective owners.