

STM8L1528-EVAL evaluation board

Introduction

The STM8L1528-EVAL evaluation board is designed as a complete demonstration and development platform for the STM8 core based STM8L152M8T6 microcontroller with I2C, two SPI channels 3 USART channels, 12-bit ADC, two 12-bit DACs, LCD driver, internal 4 KByte SRAM, 2 Kbyte data EEPROM and 64 KByte Flash program memory as well as SWIM debugging support.

The full range of hardware features on the board is provided to help you evaluate all the MCU peripherals (motor control, USART, microphone, audio DAC, LCD, IR LED, IrDA, SPI Flash, MicroSD card, temperature sensor, EEPROM... etc.) and develop your own applications. Extension headers make it possible to easily connect a daughter board or wrapping board for your specific application.

An ST-LINK/V2 is integrated on the board as embedded in-circuit debugger and programmer for the STM8 MCU.

Figure 1. STM8L1528-EVAL evaluation board



Contents

- 1 Overview 4**
 - 1.1 Features 4
 - 1.2 Demonstration software 4
 - 1.3 Order code 4

- 2 Hardware layout and configuration 5**
 - 2.1 Development and debug support 6
 - 2.2 Power supply 7
 - 2.3 Clock source 9
 - 2.4 Reset source 9
 - 2.5 LCD glass module 10
 - 2.6 Audio 11
 - 2.7 EEPROM 11
 - 2.8 RS232 & IrDA 12
 - 2.9 Motor control 12
 - 2.10 MicroSD card 13
 - 2.11 Analog input 13
 - 2.12 Serial Flash 14
 - 2.13 Temperature sensor 14
 - 2.14 Display and input devices 14
 - 2.15 IDD measurement 15
 - 2.15.1 Run mode 15
 - 2.15.2 Low power mode 15
 - 2.16 IR LED & IR receiver 16
 - 2.17 Touch sensing buttons 17

- 3 Connectors 18**
 - 3.1 Motor control connector CN1 18
 - 3.2 BNC connector CN2 19
 - 3.3 Daughter board extension connector CN3 and CN4 19
 - 3.4 SWIM connectors CN5 and CN8 25
 - 3.5 LCD Glass connector CN6 and CN10 26

3.6	RS232 connector CN7	26
3.7	USB Type B connector CN9	26
3.8	ST-LINK/V2 programming connector CN11	27
3.9	Power connector CN12	27
3.10	MicroSD connector CN15	28
4	Schematics	29
	Appendix A STM8L1528-EVAL IO pin assignment	42
	Revision history	45

1 Overview

1.1 Features

- Three 5 V power supply options: Power jack, ST-LINK/V2 USB connector or daughter board
- Audio speaker and microphone connected to DAC and ADC of STM8L152M8T6
- 1G Byte (or more) SPI interface MicroSD card
- 128 Mbit SPI serial Flash
- I²C compatible serial interface 64 Kbit EEPROM and SMBus temperature sensor
- RS232 communication
- IrDA transceiver
- Inductor Motor Control connector
- SWIM debug support, embedded ST-LINK/V2
- 122x32 Dot matrix LCD connected to SPI interface of STM8L152M8T6
- Joystick with 4-direction control and selector
- Reset, Tamper and User button
- Two touch-sensing buttons
- 4 color LEDs and one bi-color LED
- MCU consumption measurement circuit
- LCD glass (40seg x 8com) connected to STM8L152M8T6's on-chip LCD driver
- Extension connector for daughter board or wrapping board
- MCU voltage selectable 3.3 V or adjustable from 1.65 V to 3.6 V
- IR LED and receiver

1.2 Demonstration software

Demonstration software is preloaded in the board's Flash memory for easy demonstration of the device peripherals in stand-alone mode. For more information and to download the latest version available, please refer to STM8L1528-EVAL demonstration software available on the ST website: www.st.com.

1.3 Order code

To order the STM8L152M8T6 MCU evaluation board, use the order code STM8L1528-EVAL.

2 Hardware layout and configuration

The STM8L1528-EVAL evaluation board is designed around the STM8L152M8T6 (80-pin LQFP package). The hardware block diagram [Figure 2](#) illustrates the connection between STM8L152M8T6 and peripherals (LCD glass, dot matrix LCD, serial Flash, EEPROM, temperature sensor, USART, IrDA, audio, MicroSD card, Motor Control and embedded ST-LINK/V2) and [Figure 3](#) will help you locate these features on the actual evaluation board.

Figure 2. Hardware block diagram

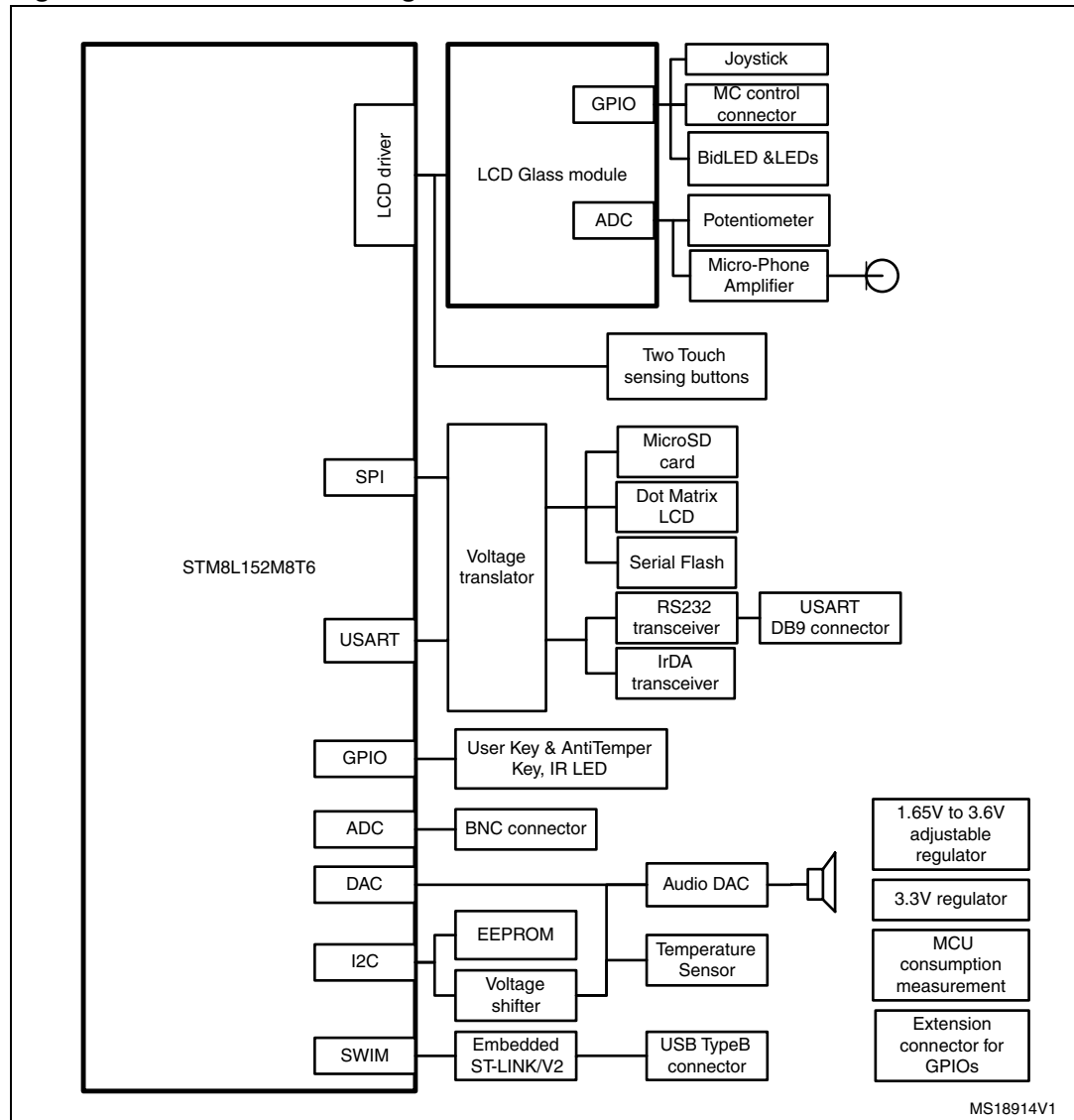
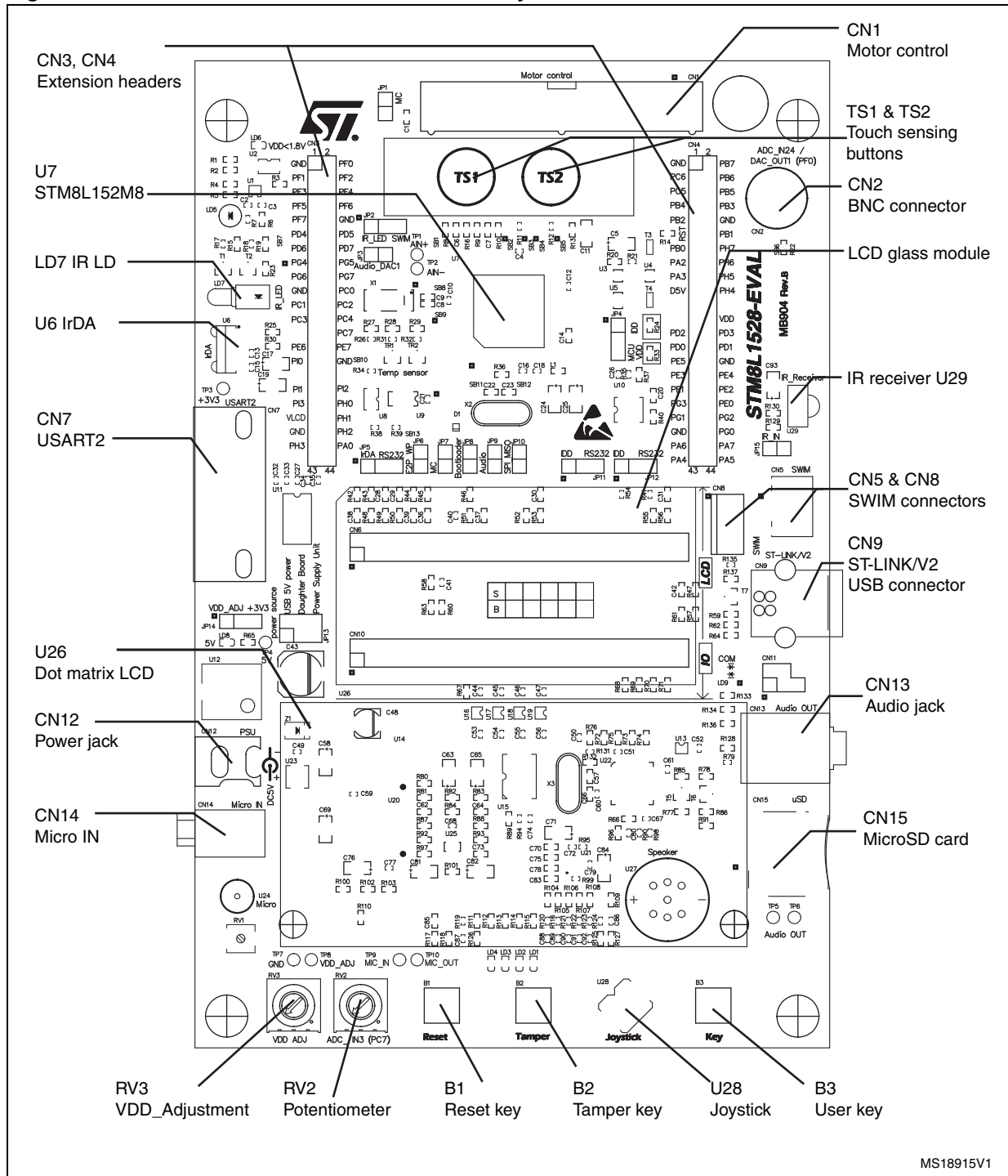

Figure 3. STM8L1528-EVAL evaluation board layout



2.1 Development and debug support

Version 2 of the ST-LINK known as ST-LINK/V2 is embedded on the board. This tool allows program loading and debugging of the STM8L on board using the SWIM interface. Third-

party debug tools are also supported by using external ERNI SWIM connector CN5 or low cost SWIM connector CN8.

A specific driver needs to be installed on your PC for communication with the embedded ST-LINK/V2. The InstallShield package ST-LINK_V2_USBdriver.exe is available from the ST website. To download and install this driver, please refer to Software and development tools page for ultra low power STM8L family available on www.st.com.

The embedded ST-LINK/V2 is connected to the PC via a standard USB cable connected to connector CN9. The bicolor LED LD9 (COM on silkscreen) advises on the status of the communication as follows:

- Slow blinking Red/Off : At power on before USB init
- Fast blinking Red/Off : After the first correct communication between PC and ST-Link/V2 (enumeration)
- Red Led On: When initialisation between PC and ST-LINK/V2 is successfully finished
- Green Led On: After successful target communication initialisation
- Blinking Red/Green: During communication with target
- Red On: Communication finished and OK
- Orange On: Communication failure

Note: It is possible to power the board via CN9 (Embedded ST-LINK/V2 USB connector) even if an external tool is connected to CN5 (ERNI connector) or CN8 (Low cost connector).

The SWIM connector or embedded ST-LINK/V2 can be enabled by setting jumper JP2.

Table 1. SWIM debugging -related jumpers

Jumper	Description	Jumper setting						
JP2	PA0 is connected to SWIM connector CN5, CN8 and embedded ST-LINK/V2 when JP2 is set as shown to the right (Default setting):	<table style="border: none; text-align: center;"> <tr> <td>1</td> <td>2</td> <td>3</td> </tr> <tr> <td>●</td> <td>●</td> <td>●</td> </tr> </table>	1	2	3	●	●	●
	1	2	3					
●	●	●						
PA0 is connected to IR LED, LD7 when JP2 is set as shown to the right.	<table style="border: none; text-align: center;"> <tr> <td>1</td> <td>2</td> <td>3</td> </tr> <tr> <td>●</td> <td>●</td> <td>●</td> </tr> </table>	1	2	3	●	●	●	
1	2	3						
●	●	●						





2.2 Power supply

STM8L1528-EVAL evaluation board is designed to be powered by a 5 V DC power supply and to be protected by PolyZen from a wrong power plug-in event. It's possible to configure the evaluation board to use any of following three sources for the power supply.

- 5 V DC power adapter connected to CN12, the Power Jack on the board (Power Supply Unit PSU in JP13 jumper description in [Table 2](#)).
- 5 V DC power with 500mA limitation from CN9, the USB type B connector for ST-LINK/V2 (USB 5 V power (USB in JP13 jumper description in [Table 2](#))).
- 5 V DC power from CN4, the extension connector for daughter board (Daughter Board power source (DTB in JP13 jumper description in [Table 2](#))).

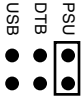
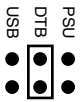
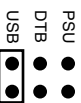
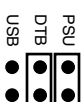
The power supply is configured by setting the related jumpers JP4, JP13 and JP14 as described in [Table 2](#).

Table 2. Power related jumpers

Jumper	Description	Jumper setting
JP13 (selects one of the three possible power supply resources)	For power supply jack (CN12) to the STM8L1528-EVAL <u>only</u> , JP13 is set as shown to the right.	
	For power supply from the daughter board connectors (CN4) to STM8L1528-EVAL <u>only</u> , JP13 is set as shown to the right:	
	For power supply from ST-LINK/V2 connector (CN9) to STM8L1528-EVAL <u>only</u> , JP13 is set as shown to the right: (Default Setting)	
	For power supply from power supply jack (CN12) to both STM8L1528-EVAL and daughter board connected on CN3 and CN4, JP13 is set as shown to the right (daughter board must not have its own power supply connected)	
JP14	VDD is connected to fixed +3.3V DC power when JP14 is set as shown (default setting).	
	VDD is connected to adjustable DC power from 1.65 V to 3.6 V when JP13 is set as shown.	
JP4	VDD power is directly connected to MCU VDD when JP4 is set as shown (default setting). <i>Note: For manual IDD measurement the jumper on JP4 must be removed and replaced by an ammeter connected between pin 2 and 3 of JP4.</i>	
	Connect VDD power to MCU with current-sampling resistor, 2 Ohm or 2 KOhm, in series for IDD current measurement when JP4 is set as shown to the right.	

The LED LD8 is lit when the STM8L1528-EVAL evaluation board is powered by the 5 V correctly, LED LD6 will be lit when MCU is powered by low voltage (VDD < 1.8 V).

Note: The recommended AC220V to DC5V power adapter is the PSU-5V2A. It is not included with the board but can be ordered from ST as a separate item. You can also use another equivalent 5V power adapter (polarity compatible with CN12) to power STM8L1528-EVAL board via the CN12 power jack on the board.

2.3 Clock source

Two clock sources are available on STM8L1528-EVAL evaluation board for STM8L152M8T6 and the embedded RTC.

- X1, 32 KHz crystal for embedded RTC
- X2, 16 MHz crystal with socket for STM8L152M8T6 microcontroller, it can be removed from its socket when the internal RC oscillator is used.

Table 3. Clock source related solder bridges

Solder bridge	Description
SB8	PC5 is connected to 32 KHz crystal when SB8 is set as pad1 (dot mark on silkscreen) connected to pad2 (default setting).
	PC5 is connected to extension connector CN4 when SB8 is set as pad2 connected to pad3.
SB9	PC6 is connected to 32KHz crystal when SB9 is set as pad2 connected to pad3 (default setting).
	PC6 is connected to extension connector CN4 when SB9 is set as pad1 (dot mark on silkscreen) connected to pad2.
SB11,SB12	IO port PA2 and PA3 can be used as GPIO on extension connector by closing solder bridges SB11 and SB12 when crystal X2 was removed from its socket. The solder bridges SB11 and SB12 should be kept open by default.

2.4 Reset source

The reset signal of STM8L1528-EVAL evaluation board is low active and the reset sources include:

- Reset button B1
- Debugging tools from SWIM connector CN5 and CN8
- Daughter board from CN4
- Embedded ST-LINK/V2
- RS232 connector CN7 for ISP.

Table 4. Reset related jumpers

Jumper	Description
JP8	The board Reset is managed by pin 8 of connector CN7 (RS232 CTS signal) when JP8 is closed. This configuration is used for boot loader application only. Default Setting: Not fitted.

2.5 LCD glass module

A LCD glass module (MB905) with Liquid Crystal Display is mounted on STM8L1528-EVAL evaluation board. It can be connected to LCD driver of STM8L152M8T6 or work as a set of jumpers by mounting it on two possible positions, "IO position" or "LCD position".

- **IO position :** All peripherals (LEDs, Joystick, Bi-color LED, potentiometer, Motor control, MicroSD card and Microphone) shared with LCD glass are connected to STM8L152M8T6 and LCD glass is disconnected when LCD glass module is mounted in IO position as shown below (default setting).

Figure 4. LCD glass module in IO position

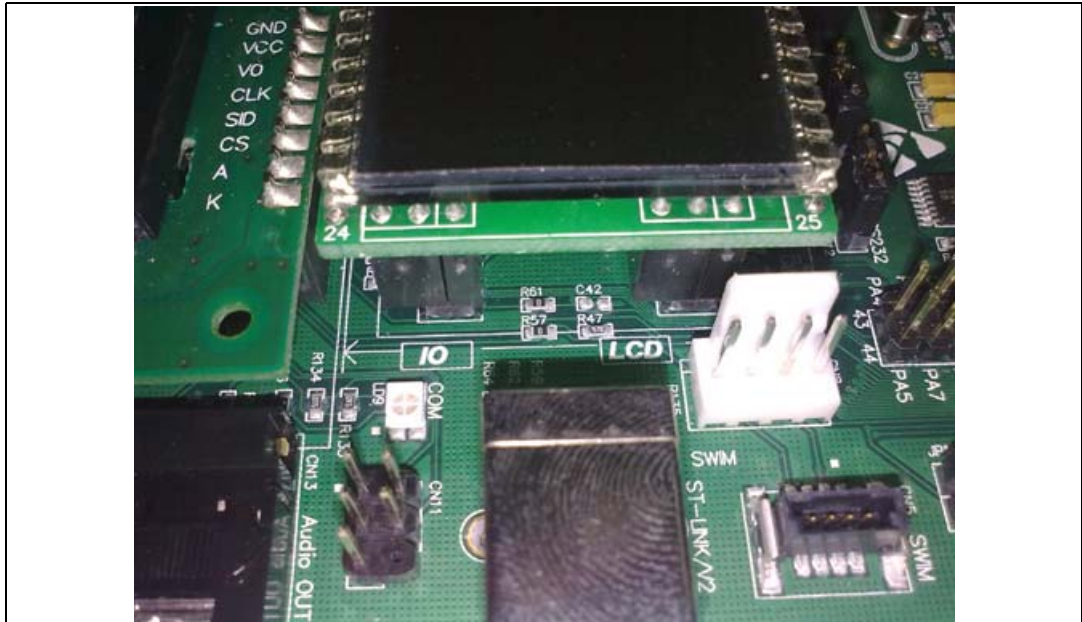

- **LCD position:** LCD glass is connected to LCD driver of STM8L152M8T6 and all peripherals shared with LCD glass are disconnected when LCD glass module is mounted on position LCD as shown below.

Figure 5. LCD glass module in LCD position



2.6 Audio

STM8L1528-EVAL evaluation board supports the following audio jacks

- A speaker and stereo audio jack which is connected to the DAC outputs of STM8L152M8T6 through an audio amplifier
- An audio IN jack which is connected to ADC input of STM8L152M8T6 through a microphone amplifier.

The speaker can be enabled by setting of JP3 to close and the Microphone output can be connect or disconnect to STM8L152M8T6 by setting of JP9 to close or open, refer to [Table 5](#) for details.

Table 5. Audio related jumpers

Jumper	Description
JP9	The microphone is enabled when JP9 is closed. JP9 must be kept open for Motor control operation. Default setting: Fitted
JP3	PF0 is connected to audio amplifier when JP3 is closed. For BNC connector operation, JP3 must be kept open. Default setting: Fitted

The LCD glass module has to be mounted in "IO" position for Microphone and headphone plug event detection. Refer to [Section 2.5: LCD glass module on page 10](#) for details.

2.7 EEPROM

A 64 Kbit EEPROM connected to I2C bus of STM8L152M8T6.

Table 6. EEPROM related jumper and solder bridge

Jumper	Description
JP6	The I2C interface EEPROM U8 is in write protection mode when JP6 is not fitted. Default setting: Fitted
SB10	The device address of EEPROM can be changed by setting of SB10, the address is 0xA0 when SB10 is open while the address is 0xA2 when SB10 is closed. Default setting: Open

Note: The E2PROM used on the board (ref M24C64-DFW5TP) has a specified VDD range of 1.7 V to 5.5 V therefore its behavior is not guaranteed in the VDD range 1.65 V to 1.7 V.

2.8 RS232 & IrDA

Both RS232 and IrDA communication are supported by D-type 9-pin RS232 connectors CN7 and IrDA transceiver U6 which is connected to the USART of the STM8L152M8T6 on STM8L1528-EVAL evaluation board. The Bootloader_RESET signal is added to the RS232 connector for ISP support.

Table 7. RS232 & IrDA related jumpers

Jumper	Description	Setting
JP5	USART2_RX is connected to RS-232 transceiver and RS-232 communication is enabled when JP5 is set as shown to the right (default setting).	1 2 3 ● ● ●
	USART2_RX is connected to IrDA transceiver and IrDA communication is enabled when JP5 is set as shown to the right.	1 2 3 ● ● ●
JP11	PH4 is connected to RS232 or IrDA when JP11 is set as shown to the right (Default setting):	1 2 3 ● ● ●
	PH4 is connected to IDD current measurement circuit as IDD_CNT_EN signal when JP11 is set as shown to the right:	1 2 3 ● ● ●
JP12	PH5 is connected to RS232 and IrDA when JP12 is set as shown to the right (Default setting):	1 2 3 ● ● ●
	PH5 is connected to IDD current measurement circuit as LP_WAKEUP signal when JP12 is set as shown to the right:	1 2 3 ● ● ●

2.9 Motor control

The STM8L1528-EVAL evaluation board supports three-phase brushless motor control via a 34-pin connector CN1, which provides all required control and feedback signals to and from a motor power-driving board. Available signals on this connector include emergency stop, motor speed, 3 phase motor current, bus voltage, heatsink temperature coming from the motor driving board and 6 channels of PWM control signal going to the motor driving circuit.

The IO pins used on the Motor control connector CN1 are multiplexed with some of the on-board peripherals. The motor control application can be enabled by setting the related jumpers and solder bridges.

Table 8. Motor control related jumpers and solder bridges

Jumper	Description
JP7	JP7 can be used to redirect a PFC synchronization signal to the timer 3 input capture 2 pin, and to the timer3 external trigger input. Default setting: Not Fitted
JP1	JP1 should be kept open when an encoder signal is input from pin31 of CN1 while it should be kept closed when an analog signal is input from pin31 of CN1 for special type of motors. Default setting: Not Fitted
JP9	For Motor control applications, JP9 need to be kept open to avoid conflict between Microphone and Motor control connector CN1.
SB2	PE5 is connected to MC_CurrentB when SB2 is set to "pad2 connected to pad3". PF1 is connected to MC_CurrentB when SB2 is set to "pad1 connected to pad2" (Dot mark on silkscreen). Default setting: pad2 connected to pad3

Some board reworks are also needed as listed below:

- Remove 0 ohm resistors R55 to release IO which used by the Motor control and shared with Bid-LED (if Bidir LED needs to remain OFF when motor is running).
- Solder resistor 0 ohm resistors R51 and R60.

The LCD glass module has to be mounted in "IO" position for Motor control. Refer to [Section 2.5: LCD glass module on page 10](#) for details.

2.10 MicroSD card

The 1 GByte (or more) MicroSD card connected to SPI port of STM8L152M8T6 is available on the board. MicroSD card detection is managed by GPIO port PG6. Jumper JP10 must be kept closed for MicroSD card operation, refer to [Table 9](#) for details.

The LCD glass module has to be mounted in "IO" position for MicroSD card. Refer to [Section 2.5: LCD glass module on page 10](#) for details.

2.11 Analog input

The BNC connector CN2 is connected to PF0 of STM8L152M8T6 through solder bridge SB1 as external analog input or DAC output. The 50 ohm terminal resistor can be enabled by closing solder bridge SB6. A low pass filter can be implemented for the BNC connector by replacing R8 and C6 for ADC input or replacing R16 and C6 for DAC output with the resistor and capacitor values appropriate for the target application.

There are also 3 analog signals available on the board:

1. 10K ohm potentiometer RV2 connected to PC7.
2. IDD measurement output signal connected to PF3 for MCU power consumption test.
3. External ADC input which can be connected to TP1 (AIN+) and TP2 (AIN-), solder bridge SB1 should be kept open for this Analog input.

The LCD glass module has to be mounted on the "IO" position for potentiometer RV2. Refer to [Section 2.5: LCD glass module on page 10](#) for details.

2.12 Serial Flash

An M25P128 Serial Flash is connected to the SPI bus of the STM8L152M8T6. The chip select is managed by standard IO port PH7.

Table 9. Serial Flash related jumper

Jumper	Description
JP10	All SPI interface devices, microSD card, SPI Flash and LCD are connected to SPI_MISO of STM8L152M8T6 when JP10 is closed. JP10 should be kept open for SPI bootloader operation. Default setting: Fitted

2.13 Temperature sensor

An STLM75M2E temperature sensor is connected to the I2C bus of the STM8L152M8T6 through two transistors to support a wide voltage range from 1.65 V to 3.3 V on the I2C bus.

The device address of the temperature sensor can be changed by setting solder bridge SB13. the address is 0x90 when SB13 is open while address is 0x91 when SB13 is closed.

The LCD glass module has to be mounted in "IO" position for I2C_SMB signal. Refer to [Section 2.5: LCD glass module on page 10](#) for details.

2.14 Display and input devices

The 122x32 dot-matrix LCD is connected to the SPI port of the STM8L152M8T6, 4 general purpose color LED's (LD 1,2,3,4), and one bi-color LED LD5 are available as display devices. A 4-direction joystick (U28) with selection key, an anti-tamper button (B2) and a general purpose button (B3) are available as input devices.

Table 10. LCD module (122x32 dot-matrix LCD U26)

Pin no.	Signal	Description	Pin no.	Signal	Description
1	Vss	GND	5	SID	PI2
2	Vcc	+3.3V	6	CS	PF2
3	VO	-	7	A	+5V
4	CLK	PI1	8	K	GND

The LCD glass module has to be mounted in "IO" position for LEDs and joystick. Refer to [Section 2.5: LCD glass module on page 10](#) for details.

2.15 IDD measurement

For IDD measurement the circuit below is implemented on STM8L1528-EVAL. The jumpers JP4, JP11 and JP12 need to be set correspondingly for IDD measurement, please refer to [Table 2](#) and [Table 7](#) for details.

Figure 6. STM8L1528-EVAL IDD measurement circuit

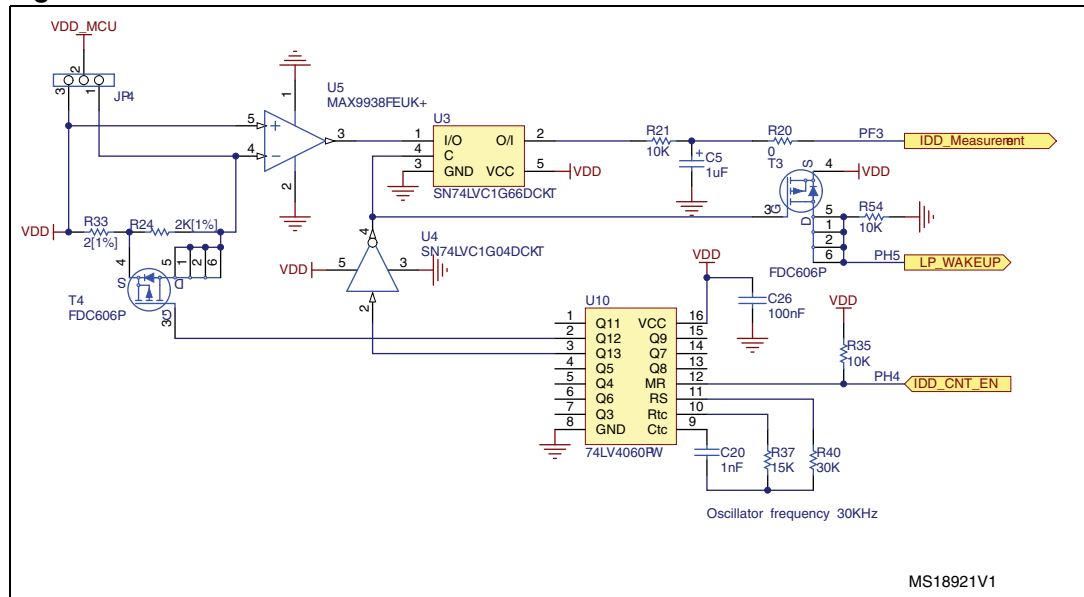

2.15.1 Run mode

In Run mode, IDD current is measured thanks to MAX9938FEUK+ (U5) connected to the 2 ohm shunt resistor. In this case IDD_CNT_EN remains at high level during measurement and jumper JP4 must be connected between pin 1 and pin 2.

2.15.2 Low power mode

In low power mode (Halt or active Halt modes), the operational amplifier MAX9938FEUK+ (U5) is connected on the 2 Kohm shunt resistor (R24). In this case the counter (U10) enabled by IDD_CNT_EN manages the measurement timing according to [Figure 7](#).

To measure a current corresponding to the low power mode the procedure is:

1. Configure ADC to measure voltage on IDD_measurement pin (PF3).
2. Configure LP_WAKEUP (PH5) as interrupt input on rising edge
3. Configuring IDD_CNT_EN (PH4) as output low level to start counting
4. Enter in Halt or active Halt mode
5. LP_WAKEUP rising edge wakeup the MCU after around 300ms
6. start ADC conversion as soon as possible after wakeup in order to measure the voltage corresponding to halt mode memorised on 1uF capacitor (C5)
7. Reset the counter by programming IDD_CNT_EN High in less than 150 ms after the wakeup to avoid 2 Kohm being connected later on VDD_MCU

In low power mode, the 2K resistor is connected when T4 goes off after entering in Halt mode. Q12 output of the counter (U10) allows connection of the 2K resistor when the current IDD becomes very low. The measurement timing is given below:

Figure 7. STM8L1528-EVAL IDD low power mode measurement timing diagram

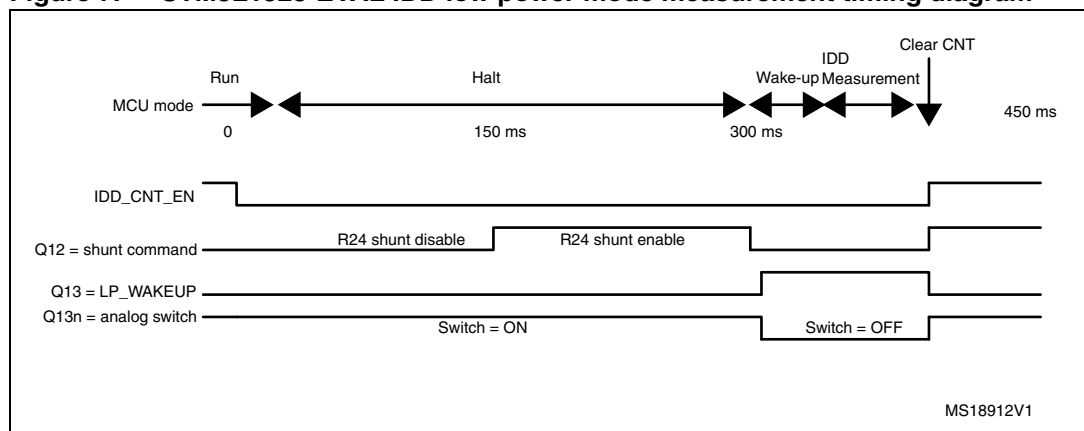

The low power mode measurement procedure can be used in Halt mode and slow or fast active Halt modes if the IDD current doesn't exceed 30uA when VDD = 3.3 V or 15 µA when VDD = 1.8 V else the Run measurement procedure need to be used up to 30 mA.

In low power mode the bias current of the operational amplifier input (U5 pin 4) is not negligible compared to IDD current (Typical I bias is ~200 nA). To improve the IDD measurement accuracy it is mandatory to subtract the I bias current to IDD measure since this current isn't sink by the MCU. It is possible to measure I bias and to subtract this value to MCU current. The procedure for precision IDD measurement is:

1. Place a jumper on JP4 pins 2 and 3
2. Follow the Halt mode procedure to measure I1 = I bias
3. Remove jumper JP4 pins 2 and 3 and place it on JP4 pins 1 and 2
4. Follow the Halt mode procedure to measure I2 = IDD + I bias
5. Calculate actual IDD: $IDD = I2 - I1$

2.16 IR LED & IR receiver

One IR LED LD7 is driven by either PA0 through two transistors T1 and T2 or PA0 directly depending on setting of solder bridge SB7. One IR receiver is connected to PB2 which shared by motor control connector through jumper JP15.

Table 11. IR LED & receiver related Solder Bridges & jumper

Solder bridge/jumper	Description
SB7	LD7 is driven by PA0 through two transistors T1 and T2 when SB7 is set as pad1 (Dot mark on silkscreen) connected to pad2. With this configuration the current driven through LD7 is around 40 mA (default setting)
	LD7 is driven by PA0 directly when SB7 is set as pad2 connected to pad3. In this configuration a current of around 10mA through LD7 is driven directly by the MCU IO PA0.
JP15	IR receiver is connected to PB2 when JP15 is closed. JP15 should be kept open for motor control application. Default setting: Fitted

Note: Jumper JP2 needs to be set correspondingly for IR LED, please refer to [Table 1](#) for details.

2.17 Touch sensing buttons

Two touch sensing buttons, TS1 and TS2, can be connected to the STM8L152M8T6 by setting the related solder bridges.

Table 12. Touch Sensing button related solder bridges

Solder bridge	Description
SB3,4,5	PB4, PB5 and PB6 are connected to LCD glass when solder bridges SB3,4 and 5 are set to pad1 (Dot mark on silkscreen) connected to pad2 (default setting)
	PB4, PB5 and PB6 are connected to Touch sensing buttons when solder bridges SB3,4 and 5 are set to pad2 connected to pad3.

3 Connectors

3.1 Motor control connector CN1

Figure 8. Motor control connector CN1

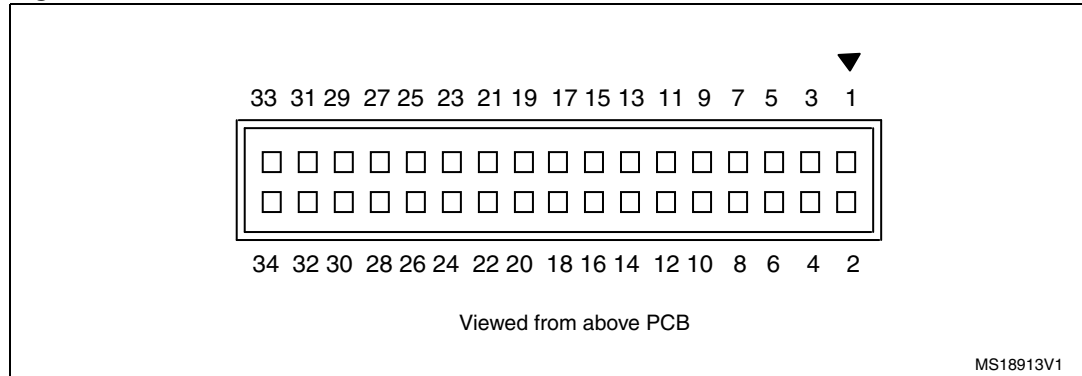

Table 13. Motor control connector CN1 pin assignments

Description	Pin of STM8L152M8T6	Pin number of CN17	Pin number of CN17	Pin of STM8L152M8T6	Description
EMERGENCY STOP	PD6	1	2		GND
PWM-UH	PD2	3	4		GND
PWM-UL	PD7	5	6		GND
PWM-VH	PD4	7	8		GND
PWM-VL	PE1	9	10		GND
PWM-WH	PD5	11	12		GND
PWM-WL	PE2	13	14	PC3	BUS VOLTAGE
PHASE A CURRENT	PA4	15	16		GND
PHASE B CURRENT	PE5 or PF1	17	18		GND
PHASE C CURRENT	PA6	19	20		GND
NTC BYPASS RELAY	PE0	21	22		GND
DISSIPATIVE BRAKE PWM	PB1	23	24		GND
+5 V power	+5 V	25	26	PB3	Heatsink temperature
PFC SYNC	PD0 and PD1	27	28		VDD_Micro
PFC PWM	PB1	29	30		GND
Encoder A	PB0	31	32		GND
Encoder B	PB2	33	34	PA7	Encoder Index

3.2 BNC connector CN2

Figure 9. Analog input connector CN2 (viewed from bottom)

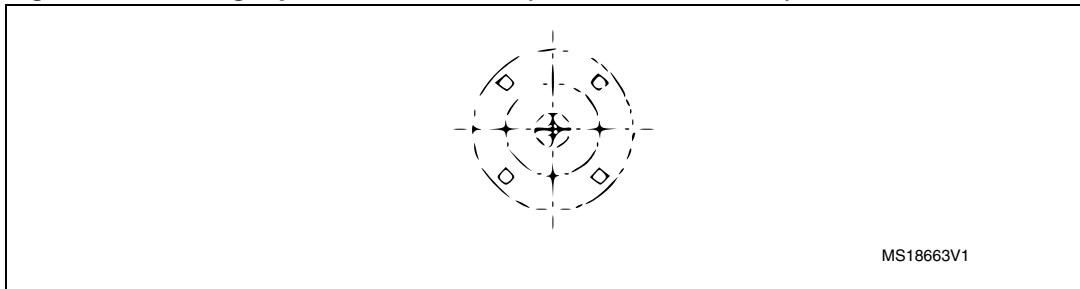

Table 14. Analog input connector CN2

Pin number	Description	Pin number	Description
1	GND	4	GND
2	GND	5	Analog input PF0
3	GND		

3.3 Daughter board extension connector CN3 and CN4

Two 44-pin male headers CN3 and CN4 can be used to connect the daughter board or a standard wrapping board to STM8L1528-EVAL evaluation board. All GPIOs are available on the connectors. The space between these two connectors and the position of power, GND and RESET pins are defined as a standard which allows to develop common daughter boards for several evaluation boards. The standard width between CN3 pin1 and CN4 pin1 is 2700mils (68.58mm). This standard has been implemented on most of the ST evaluation boards.

Each pin on CN3 and CN4 can be used by a daughter board after disconnecting it from the corresponding function block on STM8L1528-EVAL evaluation board. Please refer to [Table 15](#) and [Table 16](#) for details.

Table 15. Daughter board extension connector CN3

Pin	Description	Alternative Function	How to disconnect with function block on STM8L1528-EVAL board
1	GND	-	-
3	PF1	Audio_DAC2	Set SB2 to 2<->3
5	PF3	IDD measurement	Remove R20
7	PF5	LCD glass	Put MB905 in "IO" position
9	PF7	LCD glass	Put MB905 in "IO" position

Table 15. Daughter board extension connector CN3 (continued)

Pin	Description	Alternative Function	How to disconnect with function block on STM8L1528-EVAL board
11	PD4	LCD glass & MC	Put MB905 in "IO" position Disconnect power driver board from Motor control connector
13	PD6	LCD glass & MC	Put MB905 in "IO" position Disconnect power driver board from Motor control connector
15	PG4	LCD glass & JOY	Put MB905 in "IO" position Remove R105
17	PG6	LCD glass & SD detect	Put MB905 in "IO" position Remove SD card from CN15
19	GND	-	-
21	PC1	I2C_SCL	Remove R28
23	PC3	LCD glass & MC	Put MB905 in "IO" position Disconnect power driver board from Motor control connector
25	-	-	-
27	PE6	LCD glass	Put MB905 in "IO" position
29	PI0	Anti-temper button	Remove R111
31	-	-	-
33	PI1	SPI2_SCK	-
35	PI3	SPI2_MISO	Keep JP10 open
37	VLCD	-	-
39	GND		
41	PH3	LCD glass & LD4	Put MB905 in "IO" position Remove R68
43	-	-	-
2	PF0	Audio_DAC1 & BNC	Keep JP3 open
4	PF2	LCD_CS	-

Table 15. Daughter board extension connector CN3 (continued)

Pin	Description	Alternative Function	How to disconnect with function block on STM8L1528-EVAL board
6	PF4	LCD glass	Put MB905 in "IO" position
8	PF6	LCD glass	Put MB905 in "IO" position
10	GND	-	-
12	PD5	LCD glass & MC	Put MB905 in "IO" position Disconnect power driver board from Motor control connector
14	PD7	LCD glass & MC	Put MB905 in "IO" position Disconnect power driver board from Motor control connector
16	PG5	LCD glass & HP_Plug	Put MB905 in "IO" position remove R128
18	PG7	LCD glass & MicroSD_CS	Put MB905 in "IO" position
20	PC0	I2C_SDA	Remove R29
22	PC2	LCD glass	Put MB905 in "IO" position
24	PC4	LCD glass & I2C_SMB	Put MB905 in "IO" position Remove R27
26	PC7	LCD glass & potentiometer	Put MB905 in "IO" position Remove R110
28	PE7	LCD glass	Put MB905 in "IO" position
30	GND	-	-
32	-	-	-
34	PI2	SPI2_MOSI	-
36	PH0	LCD glass & LD1	Put MB905 in "IO" position Remove R71
38	PH1	LCD glass & LD2	Put MB905 in "IO" position Remove R70

Table 15. Daughter board extension connector CN3 (continued)

Pin	Description	Alternative Function	How to disconnect with function block on STM8L1528-EVAL board
40	PH2	LCD glass & LD3	Put MB905 in "IO" position Remove R69
42	PA0	SWIM & IR LED	Keep JP2 open
44	-	-	-

Table 16. Daughter board extension connector CN4

Pin	Description	Alternative Function	How to disconnect with function block on STM8L1528-EVAL board
1	GND	-	-
3	PC6	32KHz OSC	Set SB9 to 1<->2
5	PC5	32KHz OSC	Set SB8 to 2<->3
7	PB4	LCD glass & TS	Put MB905 in "IO" position
9	PB2	LCD glass & MC	Put MB905 in "IO" position Disconnect power driver board from Motor control connector Keep JP15 open
11	RESET	-	-
13	PB0	LCD glass & MC	Put MB905 in "IO" position Disconnect power driver board from Motor control connector
15	PA2	16MHz OSC	Remove X2 Keep SB11 closed
17	PA3	16MHz OSC	Remove X2 Keep SB12 closed
19	D5V	-	-
21	-	-	-
23	-	-	-

Table 16. Daughter board extension connector CN4 (continued)

Pin	Description	Alternative Function	How to disconnect with function block on STM8L1528-EVAL board
25	PD2	LCD glass & BidLED/MC	Put MB905 in "IO" position Remove R55 or R6 Disconnect power driver board from Motor control connector
27	PD0	LCD glass & MC	Put MB905 in "IO" position Disconnect power driver board from Motor control connector or remove JP7
29	PE5	LCD glass & MC	Put MB905 in "IO" position Disconnect power driver board from Motor control connector
31	PE3	LCD glass	Put MB905 in "IO" position
33	PE1	LCD glass & MC	Put MB905 in "IO" position Disconnect power driver board from Motor control connector
35	PG3	LCD glass & JOY	Put MB905 in "IO" position Remove R108
37	PG1	LCD glass & JOY	Put MB905 in "IO" position Remove R104
39	GND	-	-
41	PA6	LCD glass & MC	Put MB905 in "IO" position Disconnect power driver board from Motor control connector
43	PA4	LCD glass & MC	Put MB905 in "IO" position Disconnect power driver board from Motor control connector
2	PB7	LCD glass	Put MB905 in "IO" position

Table 16. Daughter board extension connector CN4 (continued)

Pin	Description	Alternative Function	How to disconnect with function block on STM8L1528-EVAL board
4	PB6	LCD glass & TS	Put MB905 in "IO" position
6	PB5	LCD glass & TS	Put MB905 in "IO" position
8	PB3	LCD glass & MC	Put MB905 in "IO" position Disconnect power driver board from Motor control connector and remove JP9
10	GND	-	-
12	PB1	LCD glass & MC	Put MB905 in "IO" position Disconnect power driver board from Motor control connector
14	PH7	Flash_CS	Remove R89
16	PH6	User Button	Remove R109
18	PH5	LP_WAKEUP & RS232	Keep JP12 in open
20	PH4	IDC_CNT_EN & RS232	Keep JP11 in open
22	-	-	-
24	VDD	-	-
26	PD3	LCD glass	Put MB905 in "IO" position
28	PD1	LCD glass & MC	Put MB905 in "IO" position Disconnect power driver board from Motor control connector
30	GND	-	-
32	PE4	LCD glass	Put MB905 in "IO" position
34	PE2	LCD glass & MC	Put MB905 in "IO" position Disconnect power driver board from Motor control connector

Table 16. Daughter board extension connector CN4 (continued)

Pin	Description	Alternative Function	How to disconnect with function block on STM8L1528-EVAL board
36	PE0	LCD glass & MC	Put MB905 in "IO" position Disconnect power driver board from Motor control connector
38	PG2	LCD glass & JOY	Put MB905 in "IO" position Remove R106
40	PG0	LCD glass & JOY	Put MB905 in "IO" position Remove R107
42	PA7	LCD glass & MC	Put MB905 in "IO" position Disconnect power driver board from Motor control connector
44	PA5	LCD glass	Put MB905 in "IO" position

Note: All IOs marked in with grey shading can be disconnected from the function block on STM8L1528-EVAL board by removing the LCD glass module (MB904) board.

3.4 SWIM connectors CN5 and CN8

Figure 10. SWIM debugging connectors CN5 and CN8

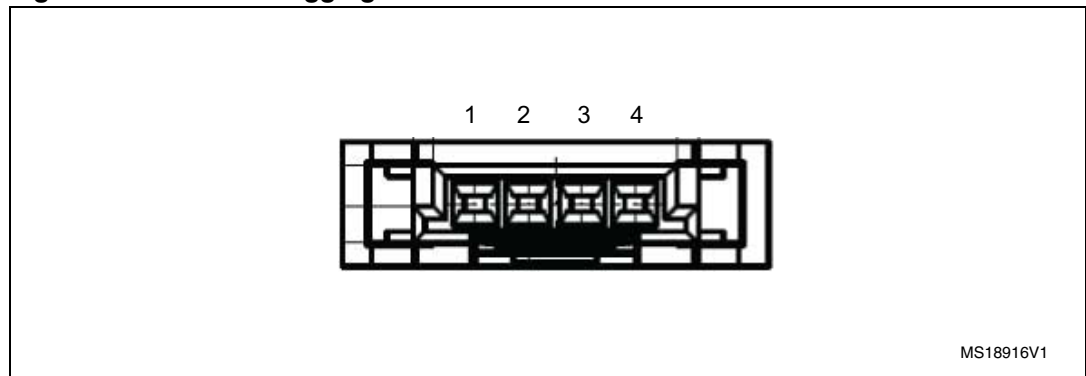

Table 17. SWIM debugging connector CN5 and CN8

Pin number	Description	Pin number	Description
1	VDD	2	SWIM line (PA0)
3	GND	4	RESET#

3.5 LCD Glass connector CN6 and CN10

Two 48-pins male headers CN6 and CN10 can be used to mount LCD glass module (MB905) on it. Two possible mount positions may be selected by user for either LCD glass demonstration or other peripherals on STM8L1528-EVAL board.

3.6 RS232 connector CN7

Figure 11. RS232 connector CN7 with ISP support (viewed from front)

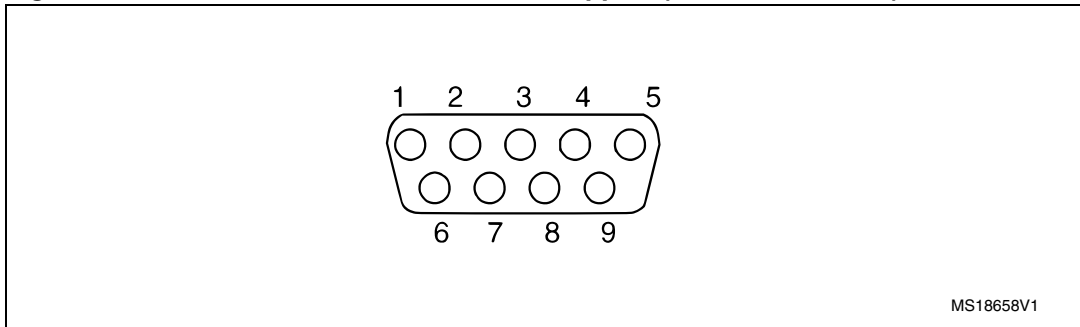

Table 18. RS232 connector CN7 with ISP support

Pin number	Description	Pin number	Description
1	NC	6	NC
2	RS232_RX (PH4)	7	NC
3	RS232_TX (PH5)	8	Bootloader_RESET
4	NC	9	NC
5	GND		

3.7 USB Type B connector CN9

The USB connector CN9 is used to connect the embedded ST-LINK/V2 to a PC for debugging.

Figure 12. USB type B connector CN9 (viewed from front)

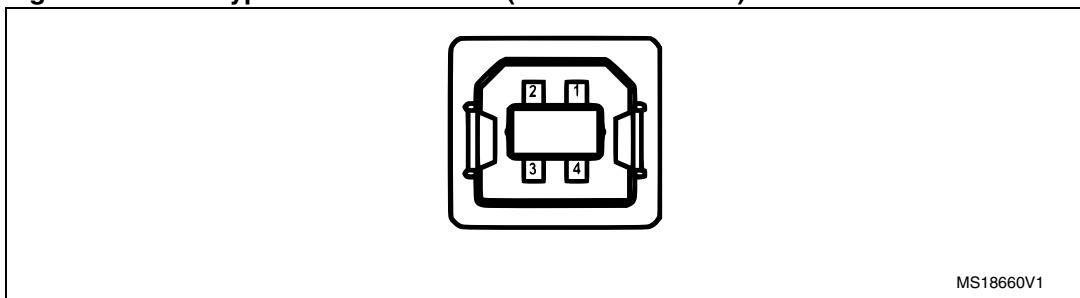

Table 19. USB type B connector CN9

Pin number	Description	Pin number	Description
1	VBUS (power)	4	GND
2	DM	5,6	Shield
3	DP		

3.8 ST-LINK/V2 programming connector CN11

The connector CN11 is used only for embedded ST-LINK/V2 programming during board manufacture. It is not populated by default and not intended for customer use.

3.9 Power connector CN12

Your STM8L1528-EVAL evaluation board can be powered from a DC 5V power supply via the external power supply jack (CN12) shown in [Figure 13](#). The central pin of CN12 must be positive.

Figure 13. Power supply connector CN12 (viewed from front)

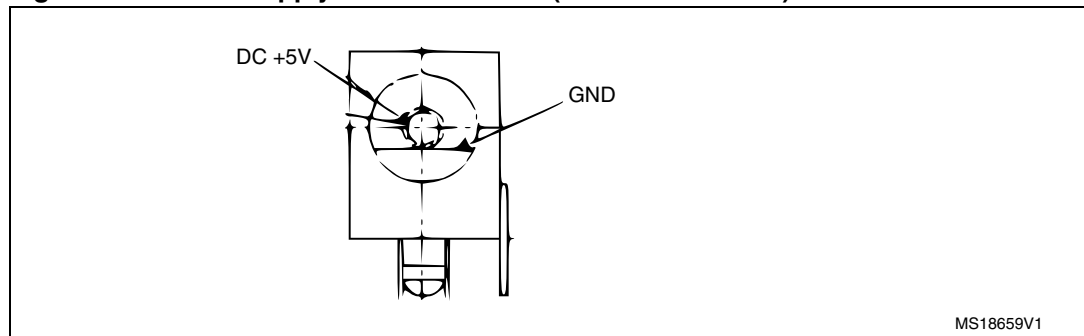

MS18659V1

3.10 MicroSD connector CN15

Figure 14. MicroSD Card connector CN15 (viewed from front)

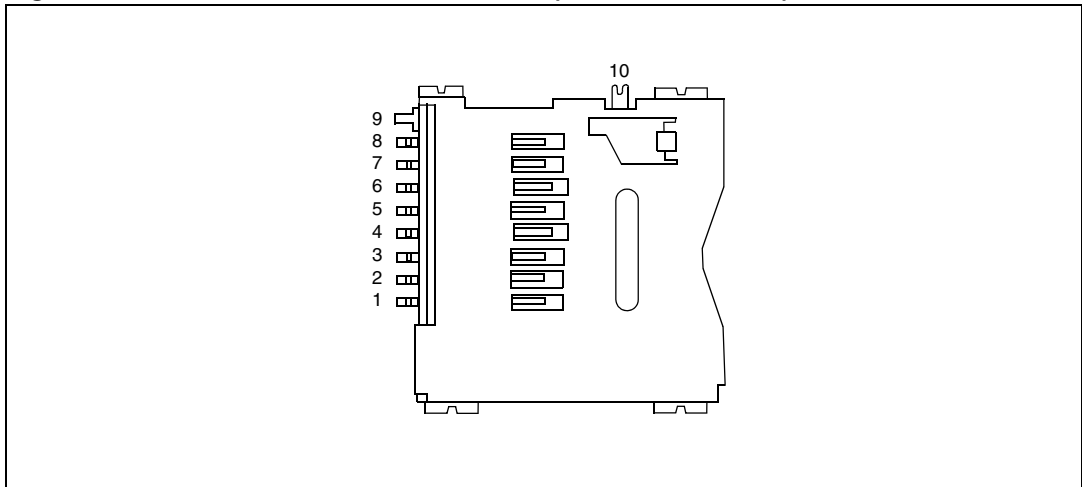
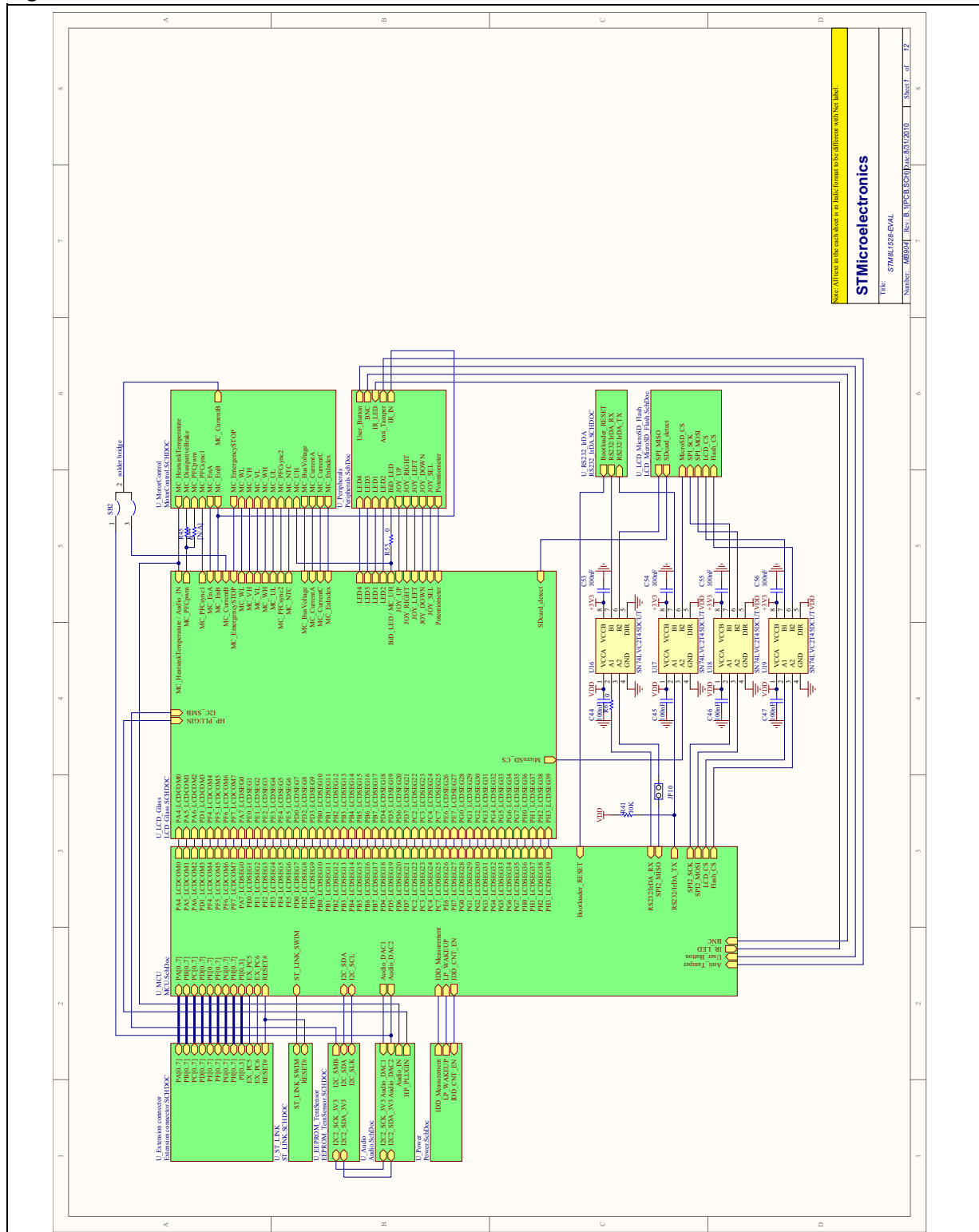

Table 20. MicroSD connector CN15

Pin number	Description	Pin number	Description
1		6	Vss/GND
2	MicroSDcard_CS (PG7)	7	MicroSDcard_DOUT (PI3)
3	MicroSDcard_DIN(PI2)	8	
4	+3V3	9	GND
5	MicroSDcard_CLK (PI1)	10	MicroSDcard_detect (PG6)

4 Schematics

Figure 15. STM8L1528-EVAL schematics sheet 1 of 12



Note: All text on this sheet is in English unless otherwise specified.

STMicroelectronics

Doc ID: 02682 Rev 10

Number: 48692 Rev 10

Page: 1 of 12



Figure 16. STM8L1528-EVAL schematics sheet 2 of 12

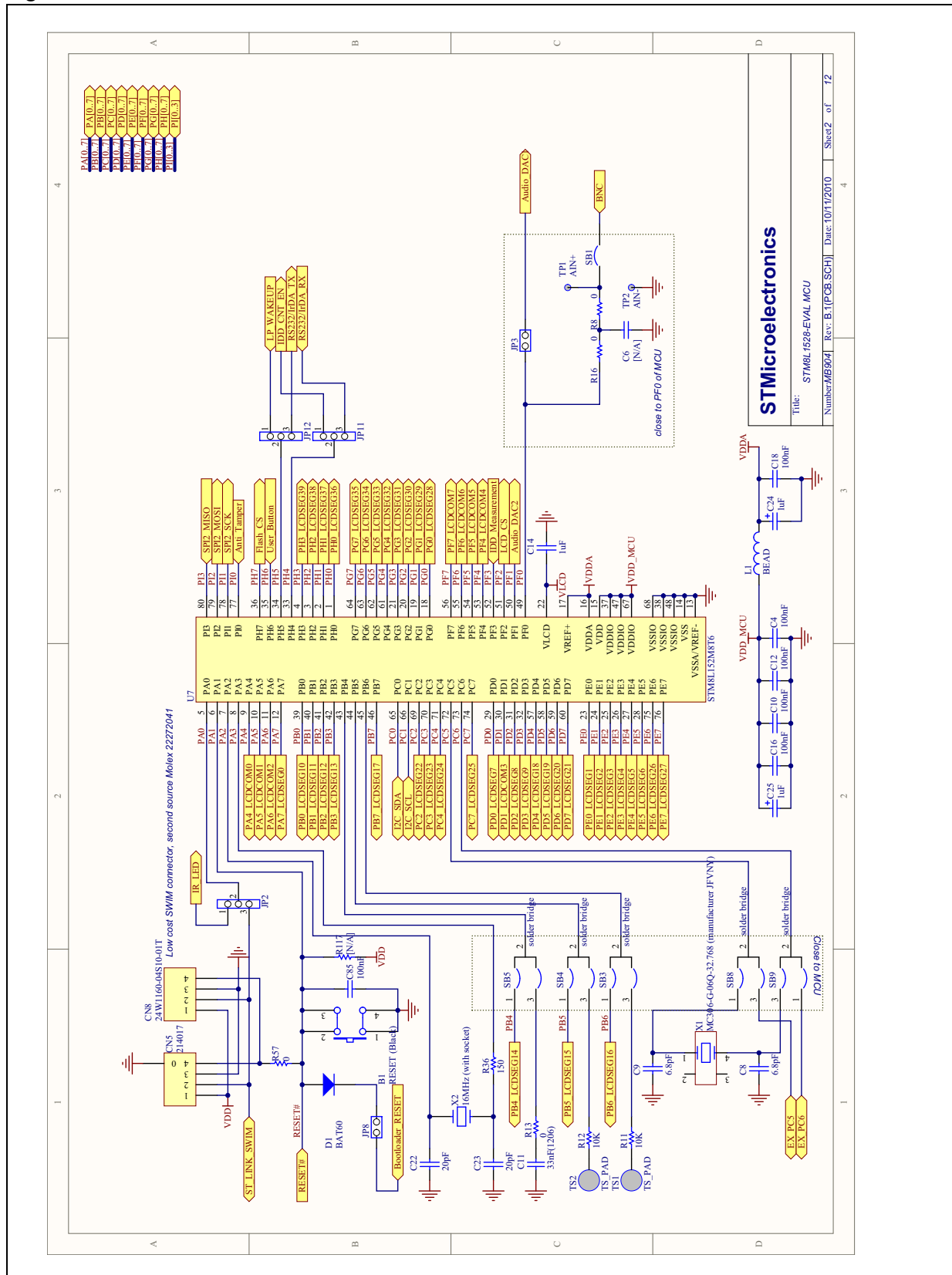
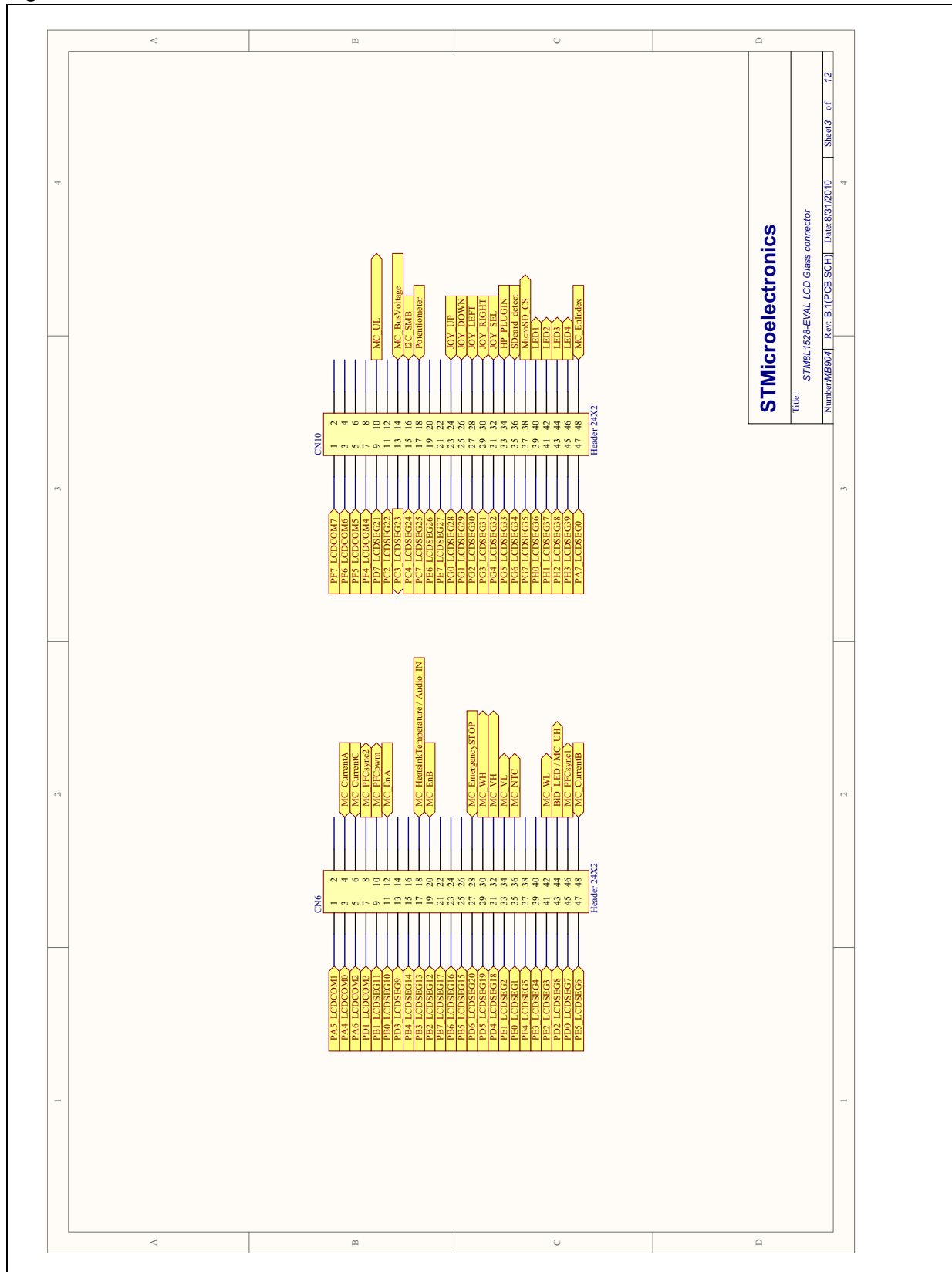

Figure 17. STM8L1528-EVAL schematics sheet 3 of 12



STMicroelectronics

Title: STM8L1528-EVAL LCD Glass connector
Number: MB904 Rev: B.1 (PCB SCH) Date: 8/31/2010
Sheet 3 of 12

Figure 18. STM8L1528-EVAL schematics sheet 4 of 12

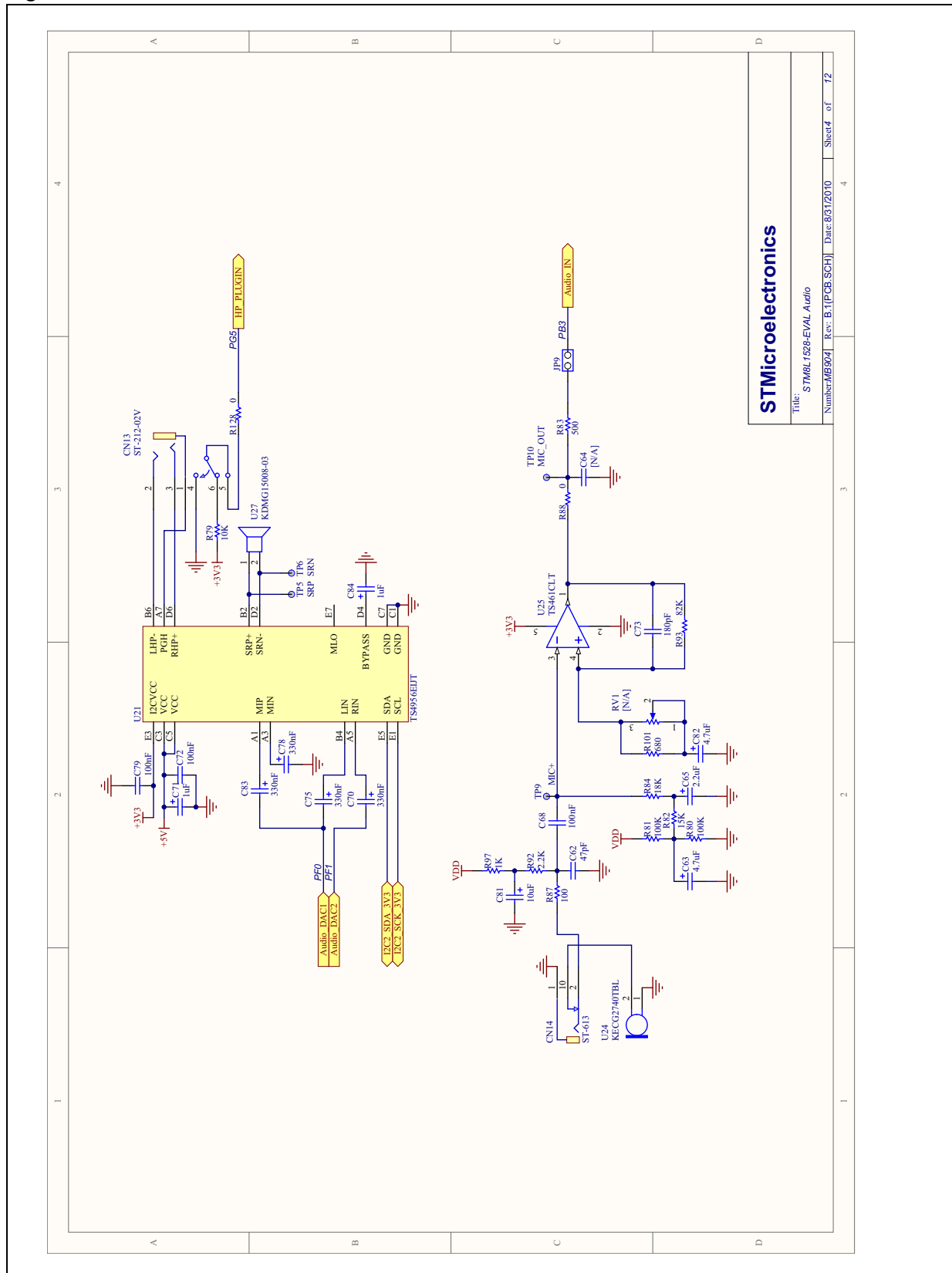

STMicroelectronics

Title: STM8L1528-EVAL Audio

Number/MS004 | Rev: B.1(PCB SCH) | Date:8/31/2010 | Sheet4 of 12

Figure 19. STM8L1528-EVAL schematics sheet 5 of 12

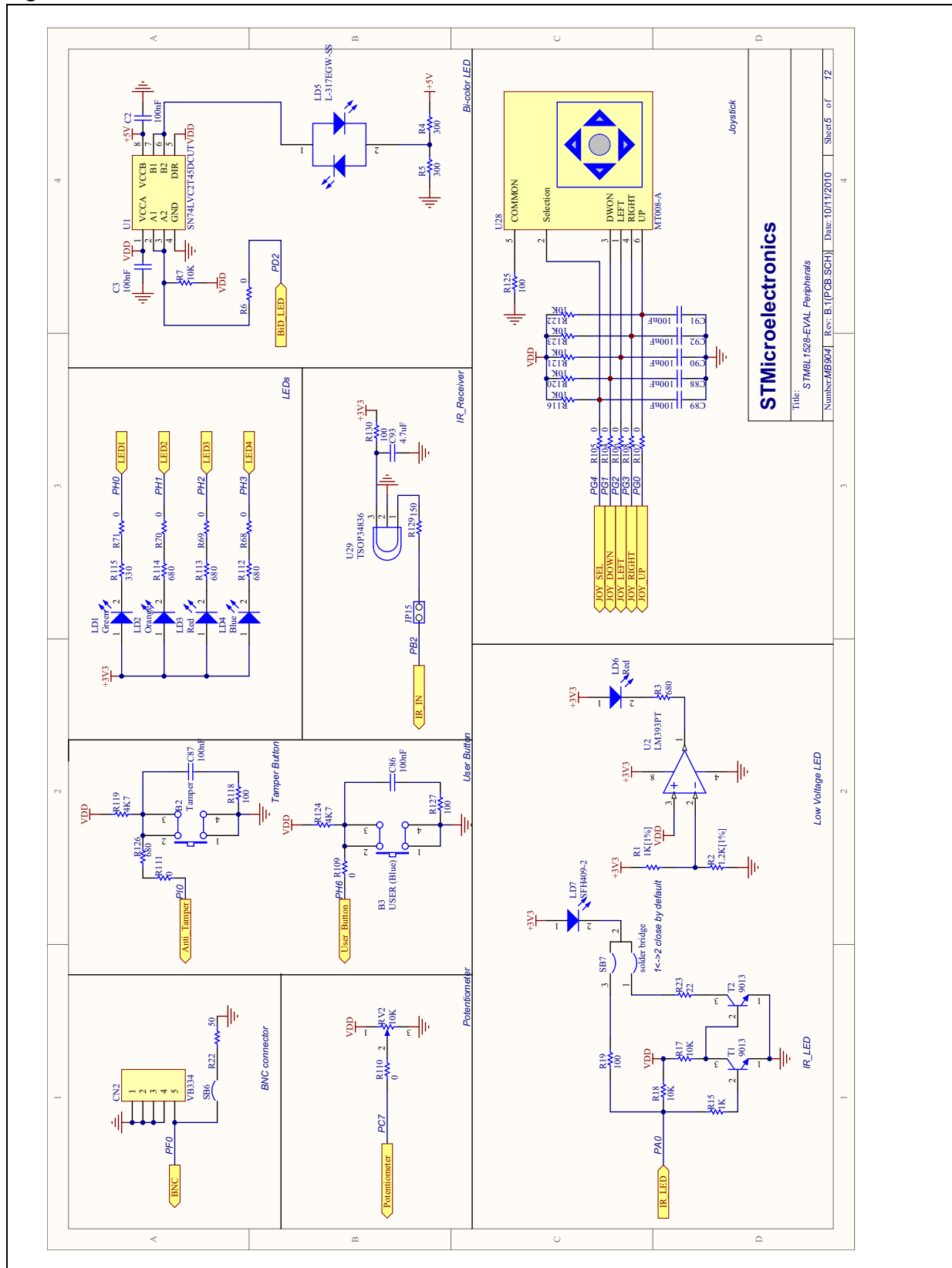

Figure 20. STM8L1528-EVAL schematics sheet 6 of 12

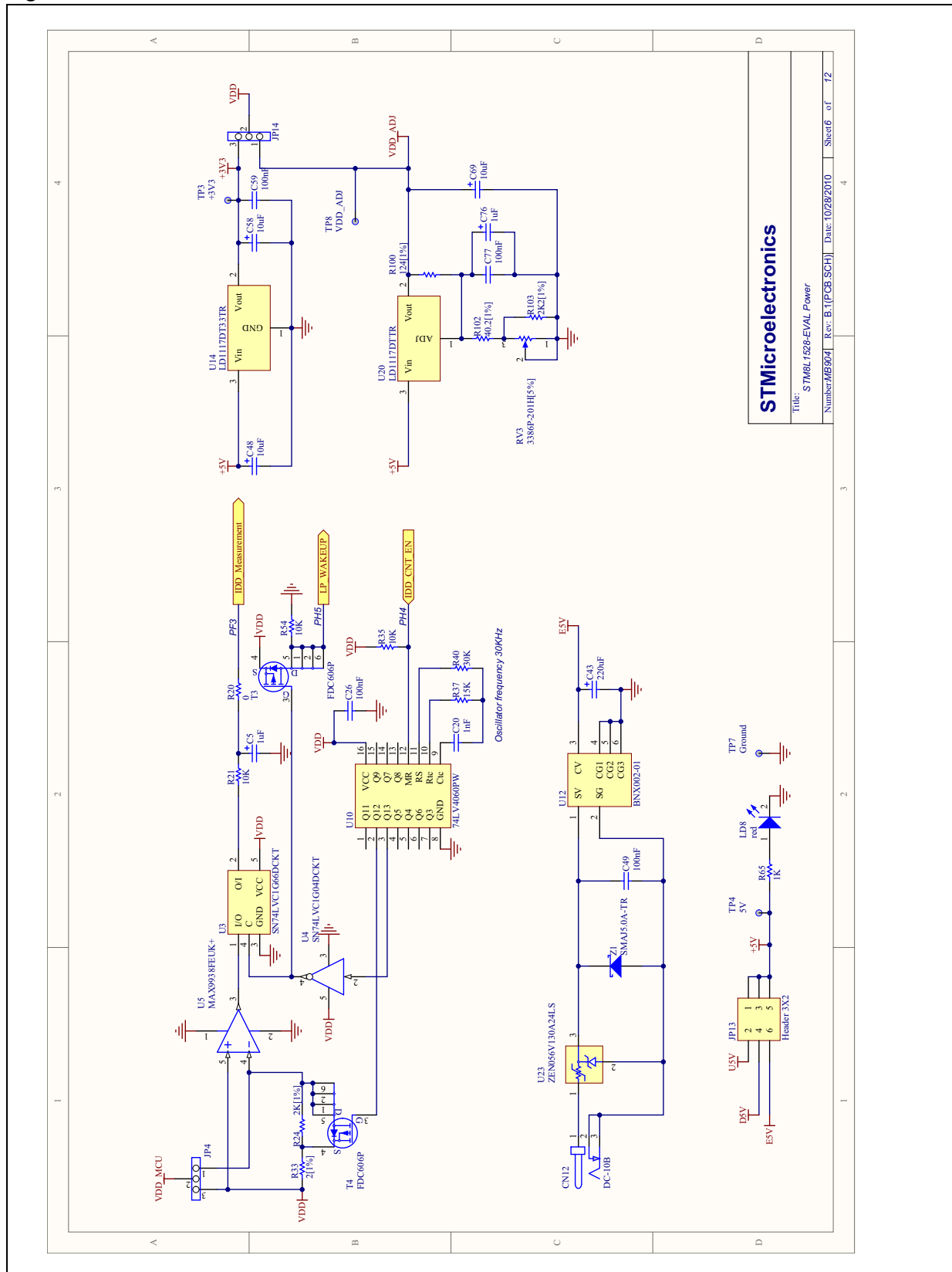

Figure 22. STM8L1528-EVAL schematics sheet 8 of 12

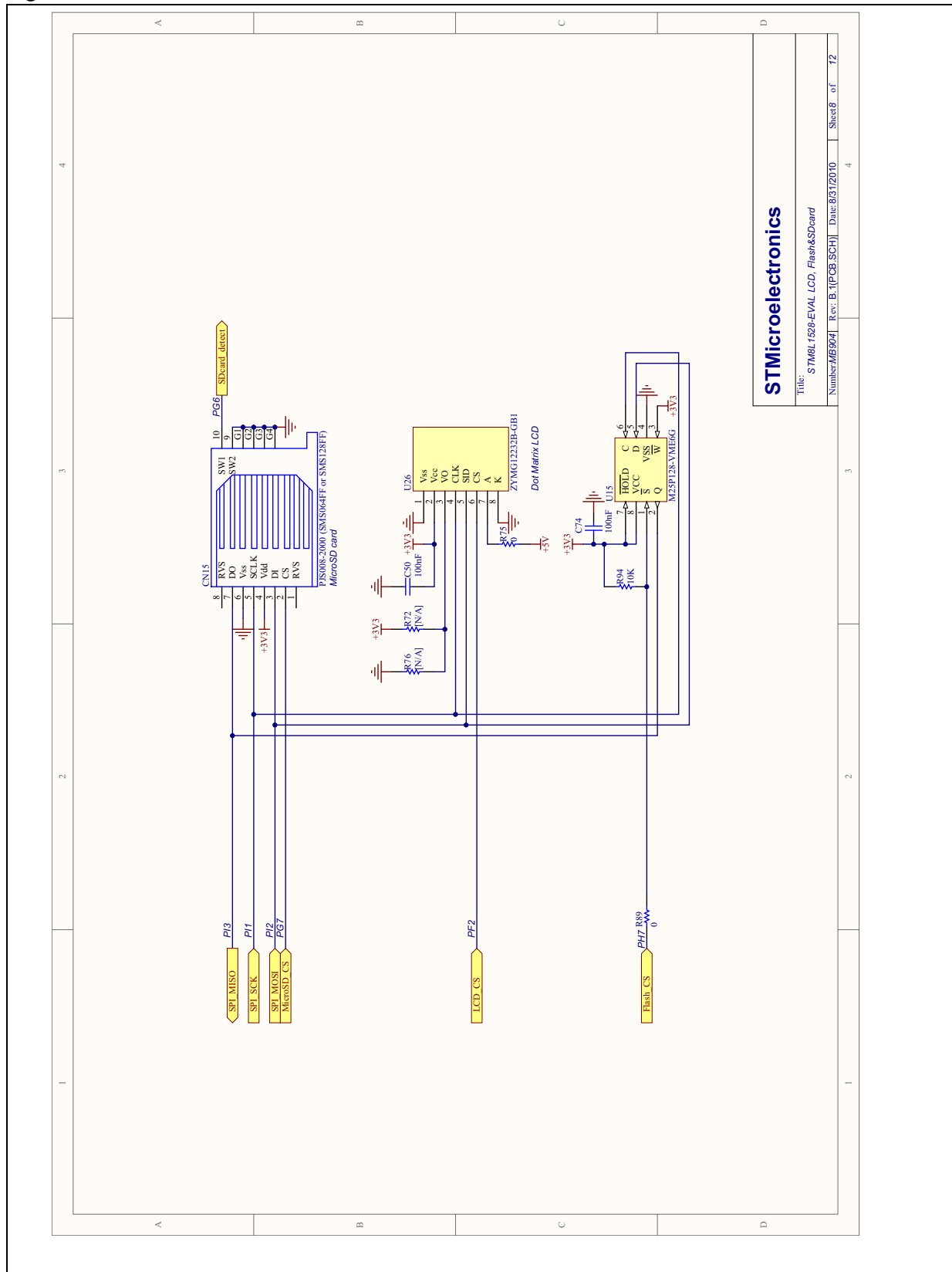

Figure 23. STM8L1528-EVAL schematics sheet 9 of 12

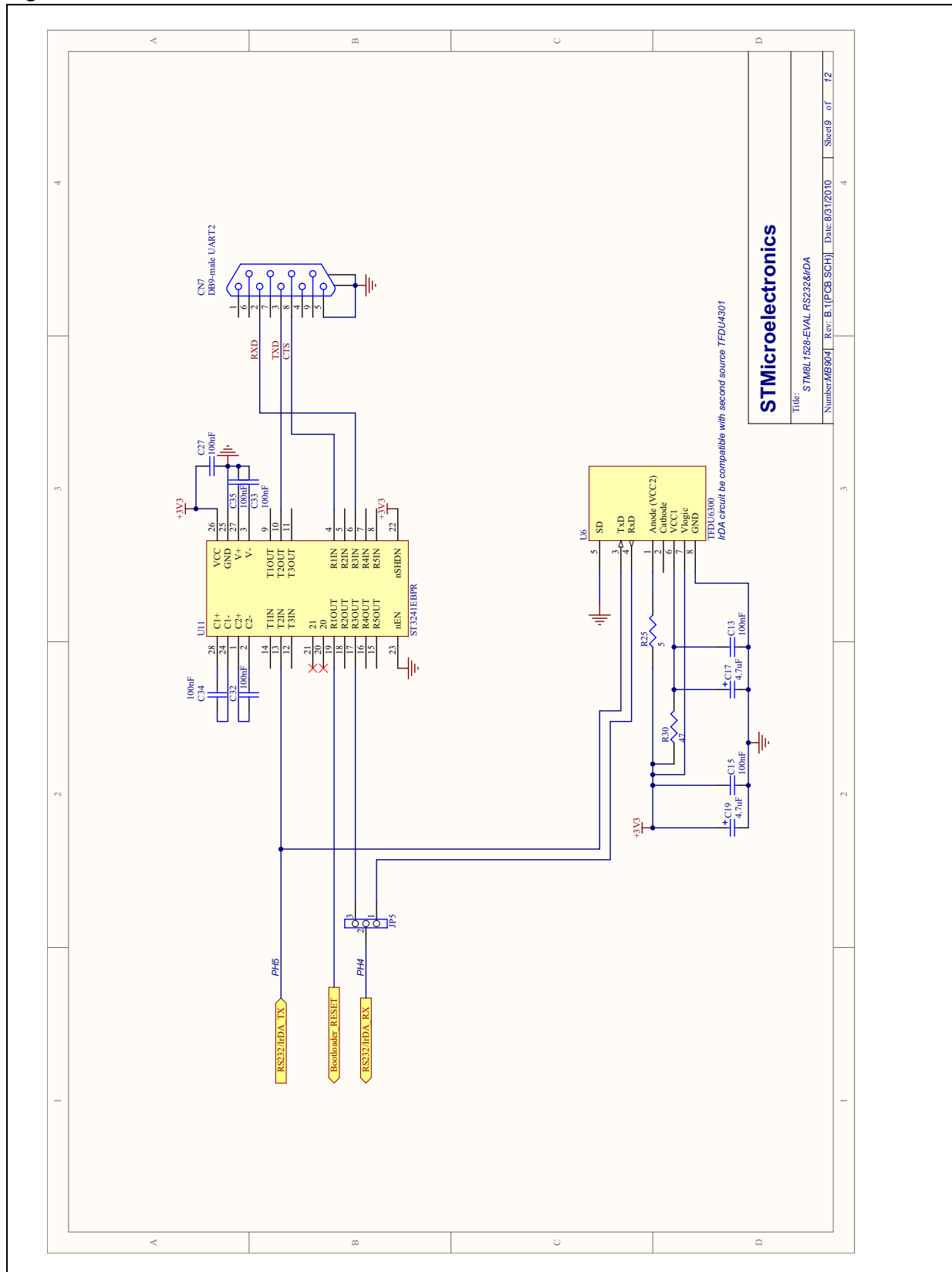
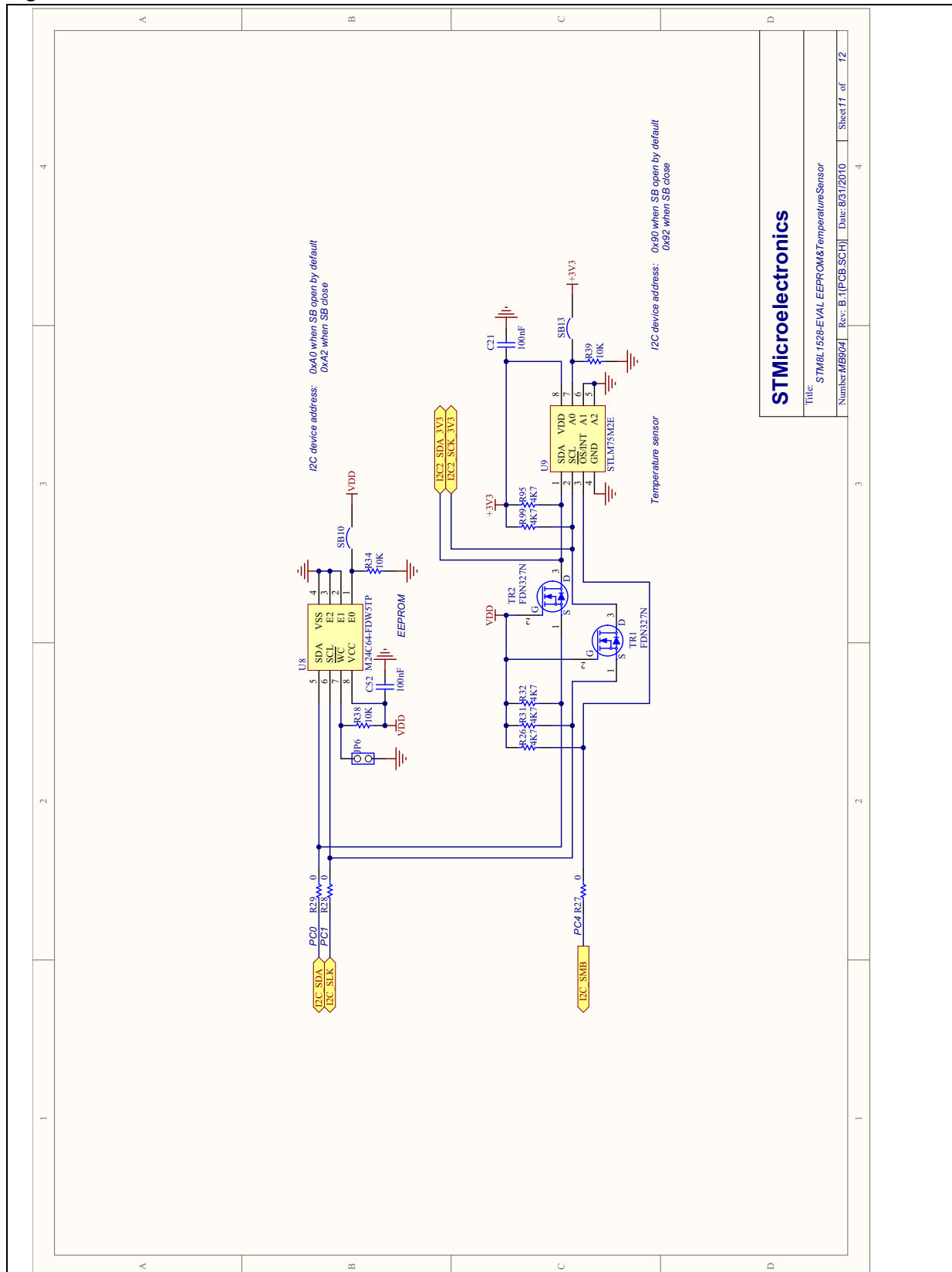

Figure 25. STM8L1528-EVAL schematics sheet 11 of 12



STMicroelectronics			
Title: STM8L1528-EVAL-EEPROM&TemperatureSensor			
Number: MB904	Rev: B.1[PCB_SCH]	Date: 8/31/2010	Sheet 11 of 12

Figure 26. STM8L1528-EVAL schematics sheet 12 of 12

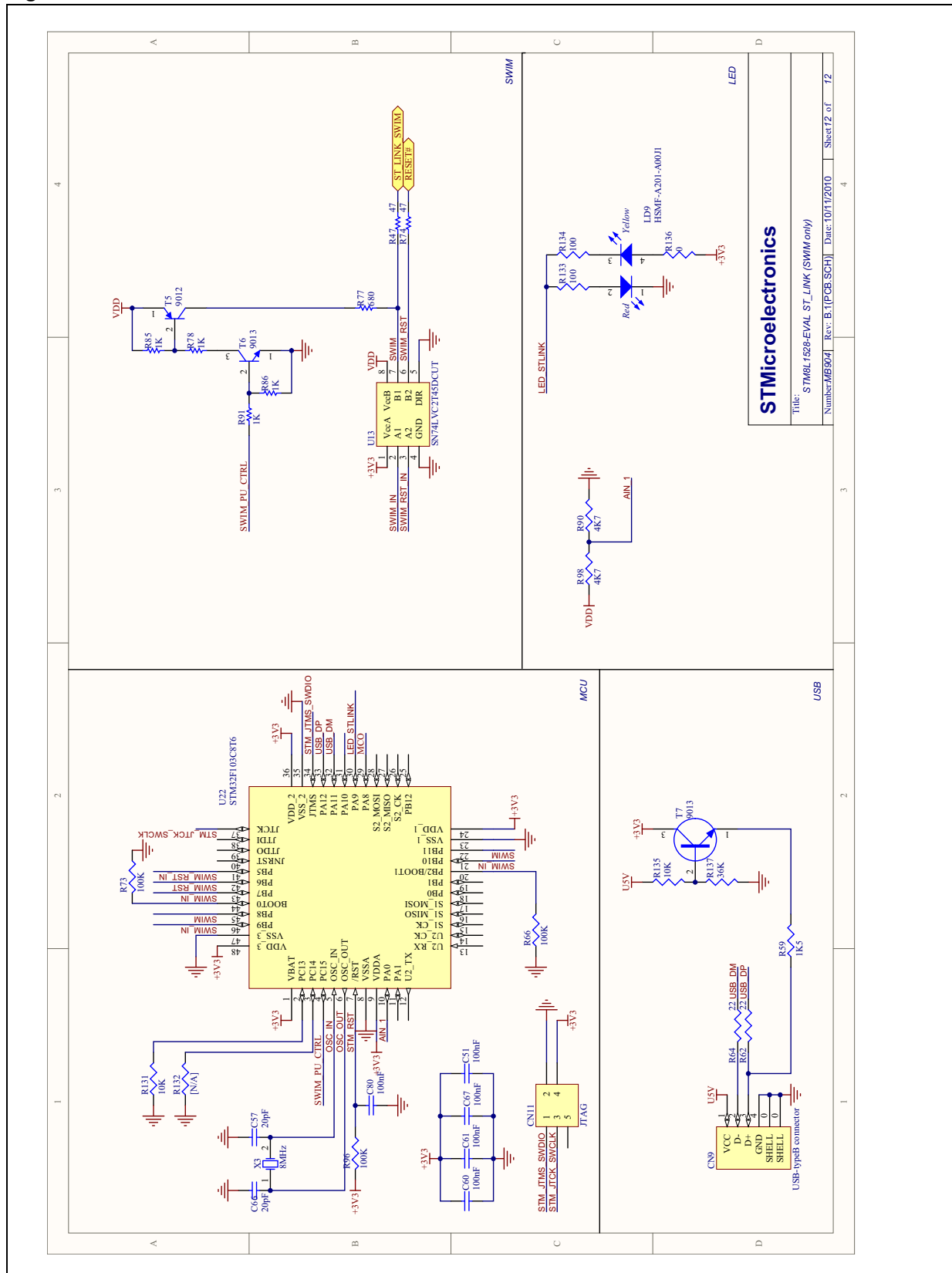
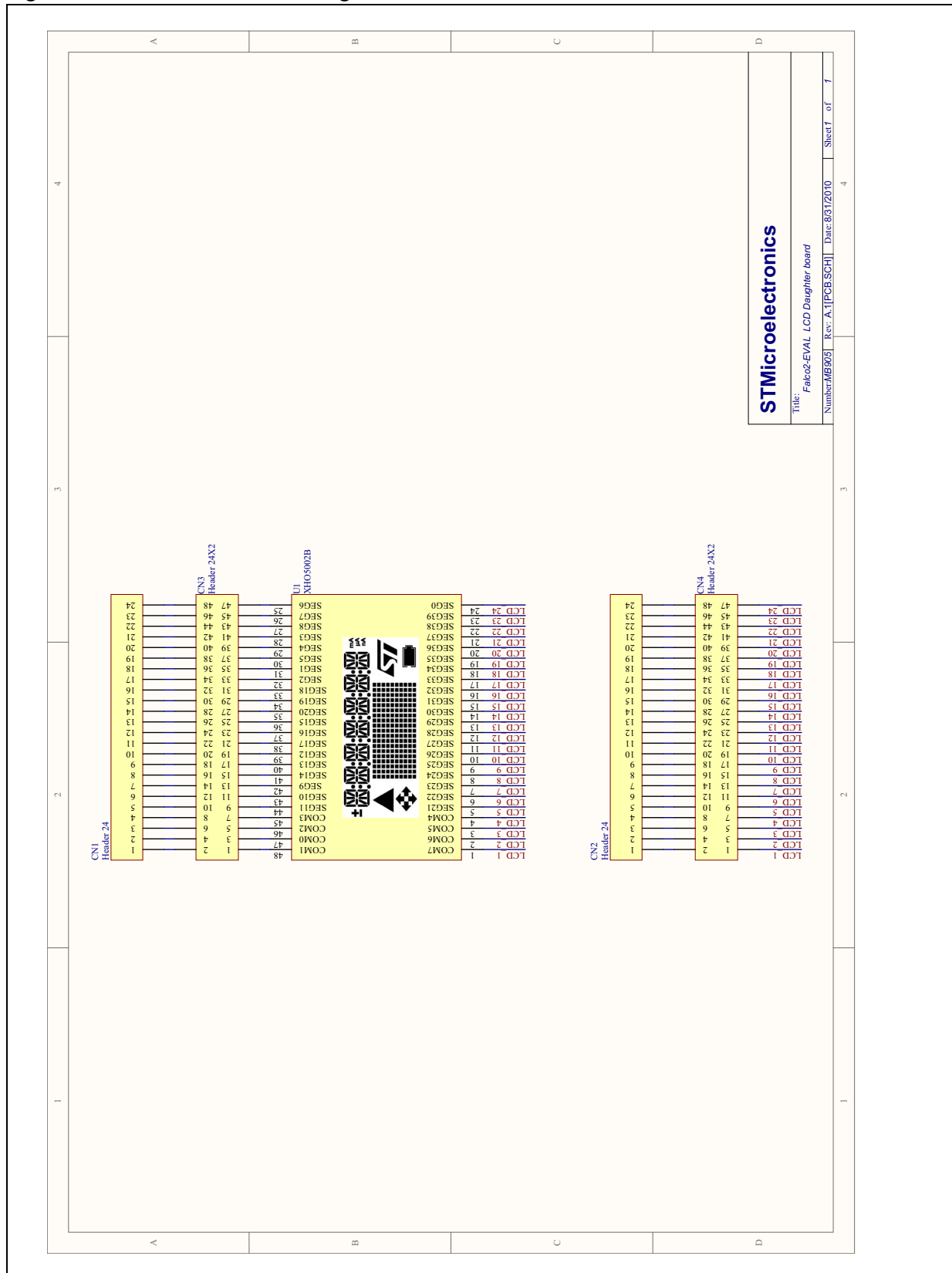

Figure 27. STM8L1528-EVAL daughter board schematics sheet 1 of 1



STMicroelectronics
Title: Falco2-EVAL LCD Daughter board
Number/MB905 | Rev: A1[PCB.SCH] | Date:8/31/2010 | Sheet 1 of 1

Appendix A STM8L1528-EVAL IO pin assignment

Table 21. IO pin assignment

Pin No.	Pin name	STM8L1528-EVAL IO assignment
1	PH0	LCD_SEG36
2	PH1	LCD_SEG37
3	PH2	LCD_SEG38
4	PH3	LCD_SEG39
5	PA0	SWIM / IR_LED
6	PA1	NRST
7	PA2	HSE_IN
8	PA3	HSE_OUT
9	PA4	LCD_COM0 / MC_CurrentA
10	PA5	LCD_COM1
11	PA6	LCD_COM2 / MC_CurrentC
12	PA7	LCD_SEG0 / MC_EnIndex
13	VSSA/VREF-	GND
14	VSS	GND
15	VDD	VDD
16	VDDA	VDDA
17	VREF+ / VREF+_DAC	VDDA
18	PG0	LCD_SEG28 / JOY_UP
19	PG1	LCD_SEG29 / JOY_DOWN
20	PG2	LCD_SEG30 / JOY_LEFT
21	PG3	LCD_SEG31 / JOY_RIGHT
22	VLCD	
23	PE0	LCD_SEG1 / MC_NTC
24	PE1	LCD_SEG2 / MC_VL
25	PE2	LCD_SEG3 / MC_WL
26	PE3	LCD_SEG4
27	PE4	LCD_SEG5
28	PE5	LCD_SEG6 / MC_CurrentB
29	PD0	LCD_SEG7 / MC_PFCsync1
30	PD1	LCD_COM3 / MC_PFCsync2
31	PD2	LCD_SEG8 / MC_UH / BidLED
32	PD3	LCD_SEG9

Table 21. IO pin assignment (continued)

Pin No.	Pin name	STM8L1528-EVAL IO assignment
33	PH4	USART2_RX / IDD_CNT_EN
34	PH5	USART2_TX / LP_WAKEUP
35	PH6	User button
36	PH7	CS_Flash
37	VDDIO	
38	VSSIO	
39	PB0	LCD_SEG10 / MC_Encoder A
40	PB1	LCD_SEG11 / MC_Dissipative brake & MC_PFC PWM
41	PB2	LCD_SEG12 / MC_Encoder B / IR_receiver
42	PB3	LCD_SEG13 / MC_headsink temperature / Microphone input
43	PB4	LCD_SEG14 / TS_Cap or Bootloader_SPI1_NSS
44	PB5	LCD_SEG15 / TS2_button or Bootloader_SPI1_SCK
45	PB6	LCD_SEG16 / TS1_button or Bootloader_SPI1_MOSI
46	PB7	LCD_SEG17 / Bootloader_SPI1_MISO
47	VDDIO	
48	VSSIO	
49	PF0	Audio_DAC1 / BNC
50	PF1	Audio_DAC2 / MC_ADC_IN25 (Current B2)
51	PF2	CS_LCD
52	PF3	IDD_measurement
53	PF4	LCD_COM4
54	PF5	LCD_COM5
55	PF6	LCD_COM6
56	PF7	LCD_COM7
57	PD4	LCD_SEG18 / MC_VH
58	PD5	LCD_SEG19 / MC_WH
59	PD6	LCD_SEG20 / MC_EmergencySTOP
60	PD7	LCD_SEG21 / MC_UL
61	PG4	LCD_SEG32 / JOY_SEL
62	PG5	LCD_SEG33 / headphone_detect
63	PG6	LCD_SEG34 / MicroSD detect
64	PG7	LCD_SEG35 / MicroSD_CS
65	PC0	I ² C SDA

Table 21. IO pin assignment (continued)

Pin No.	Pin name	STM8L1528-EVAL IO assignment
66	PC1	I ² C SCL
67	VDDIO	
68	VSSIO	
69	PC2	LCD_SEG22
70	PC3	LCD_SEG23 / MC_BusVoltage
71	PC4	LCD_SEG24 / I ² C_SMB
72	PC5	LSE_IN
73	PC6	LSE_OUT
74	PC7	LCD_SEG25 / potentiometer
75	PE6	LCD_SEG26
76	PE7	LCD_SEG27
77	PI0	Anti-tamper button / SPI2_Bootloader_NSS
78	PI1	LCD-uSD-Flash_SPI2_SCK
79	PI2	LCD-uSD-Flash_SPI2_MOSI
80	PI3	uSD-Flash_SPI2_MISO

Revision history

Table 22. Document revision history

Date	Revision	Changes
10-Dec-2010	1	Initial release.

Please Read Carefully:

Information in this document is provided solely in connection with ST products. STMicroelectronics NV and its subsidiaries ("ST") reserve the right to make changes, corrections, modifications or improvements, to this document, and the products and services described herein at any time, without notice.

All ST products are sold pursuant to ST's terms and conditions of sale.

Purchasers are solely responsible for the choice, selection and use of the ST products and services described herein, and ST assumes no liability whatsoever relating to the choice, selection or use of the ST products and services described herein.

No license, express or implied, by estoppel or otherwise, to any intellectual property rights is granted under this document. If any part of this document refers to any third party products or services it shall not be deemed a license grant by ST for the use of such third party products or services, or any intellectual property contained therein or considered as a warranty covering the use in any manner whatsoever of such third party products or services or any intellectual property contained therein.

UNLESS OTHERWISE SET FORTH IN ST'S TERMS AND CONDITIONS OF SALE ST DISCLAIMS ANY EXPRESS OR IMPLIED WARRANTY WITH RESPECT TO THE USE AND/OR SALE OF ST PRODUCTS INCLUDING WITHOUT LIMITATION IMPLIED WARRANTIES OF MERCHANTABILITY, FITNESS FOR A PARTICULAR PURPOSE (AND THEIR EQUIVALENTS UNDER THE LAWS OF ANY JURISDICTION), OR INFRINGEMENT OF ANY PATENT, COPYRIGHT OR OTHER INTELLECTUAL PROPERTY RIGHT.

UNLESS EXPRESSLY APPROVED IN WRITING BY AN AUTHORIZED ST REPRESENTATIVE, ST PRODUCTS ARE NOT RECOMMENDED, AUTHORIZED OR WARRANTED FOR USE IN MILITARY, AIR CRAFT, SPACE, LIFE SAVING, OR LIFE SUSTAINING APPLICATIONS, NOR IN PRODUCTS OR SYSTEMS WHERE FAILURE OR MALFUNCTION MAY RESULT IN PERSONAL INJURY, DEATH, OR SEVERE PROPERTY OR ENVIRONMENTAL DAMAGE. ST PRODUCTS WHICH ARE NOT SPECIFIED AS "AUTOMOTIVE GRADE" MAY ONLY BE USED IN AUTOMOTIVE APPLICATIONS AT USER'S OWN RISK.

Resale of ST products with provisions different from the statements and/or technical features set forth in this document shall immediately void any warranty granted by ST for the ST product or service described herein and shall not create or extend in any manner whatsoever, any liability of ST.

ST and the ST logo are trademarks or registered trademarks of ST in various countries.

Information in this document supersedes and replaces all information previously supplied.

The ST logo is a registered trademark of STMicroelectronics. All other names are the property of their respective owners.

© 2010 STMicroelectronics - All rights reserved

STMicroelectronics group of companies

Australia - Belgium - Brazil - Canada - China - Czech Republic - Finland - France - Germany - Hong Kong - India - Israel - Italy - Japan - Malaysia - Malta - Morocco - Philippines - Singapore - Spain - Sweden - Switzerland - United Kingdom - United States of America

www.st.com