

# NB3L202KMNGEVB

## NB3L202K Evaluation Board User's Manual



ON Semiconductor®

[www.onsemi.com](http://www.onsemi.com)

### Introduction

The NB3L202K is a differential 1:2 HCSL Clock Fanout Buffer. Inputs can directly accept differential LVPECL, LVDS and HCSL signals. This evaluation board was designed to provide a flexible and convenient platform to quickly evaluate and characterize the operation of the NB3L202K.

This manual should be used in conjunction with the device datasheet which contains full technical details on the device specifications and operation.

### EVAl BOARD USER'S MANUAL

This evaluation board manual contains:

- Information on the NB3L202K Evaluation Board
- Block Diagram and Board Schematic
- Test and Measurement Setup Procedures
- Bill of Materials

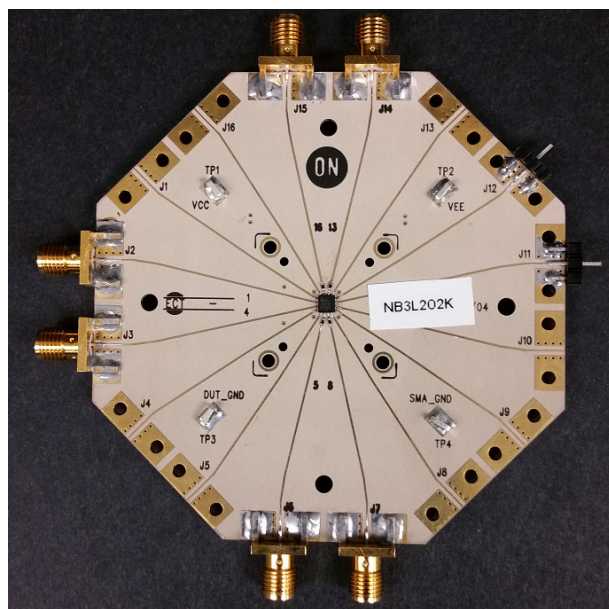

Top View

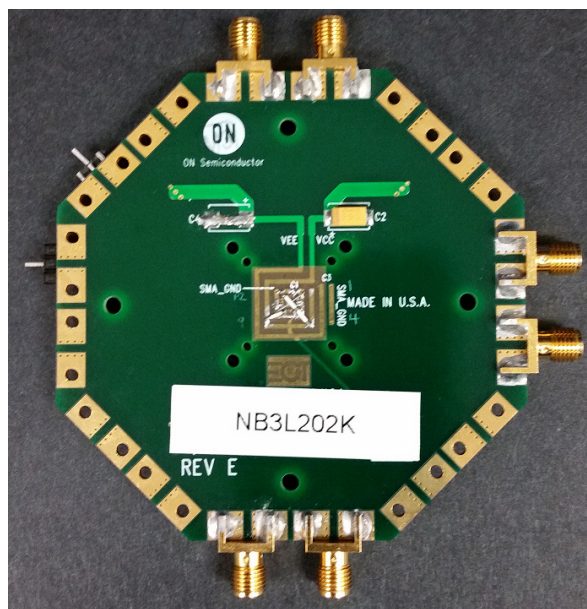

Bottom View

Figure 1. NB3L202K Evaluation Board

# NB3L202KMNGEVB

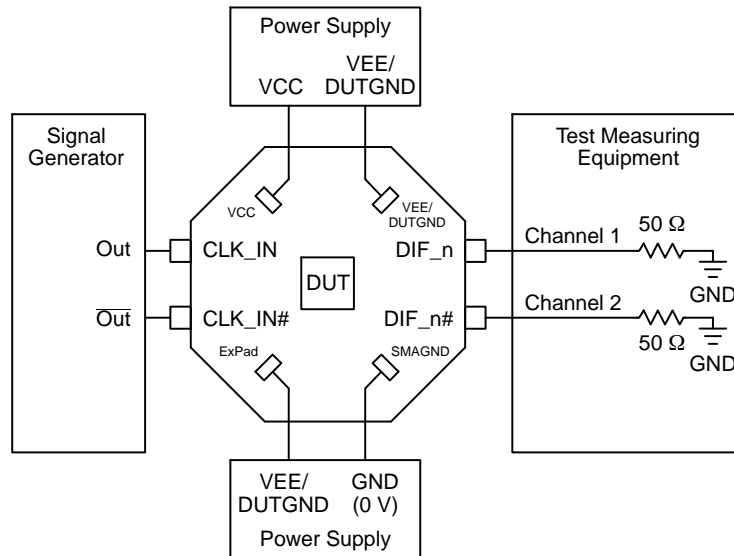

**Figure 2. Basic Lab Setup**

### Equipment Required

- DC Power Supply
- Oscilloscope
- Signal Generator
- 50-Ω Cables

### Power Supplies and Ground

On the top side of the evaluation board, there are four test points electrically connected to:

- TP1 = VCC
- TP2 = DUTGND
- TP3 = Exposed Pad
- TP4 = SMAGND = 0 V

TP1 is connected to VDD and VDDO. TP2, TP3 and TP4 are connected to GND.

**Table 1. NB3L202K, HCSL OUTPUTS POWER SUPPLY CONFIGURATION**

Device Pin Power Supply Connector	Power Supply
VDD	VCC = +3.3 V
DUTGND & SMAGND	0 V

### Single Power Supply Connections

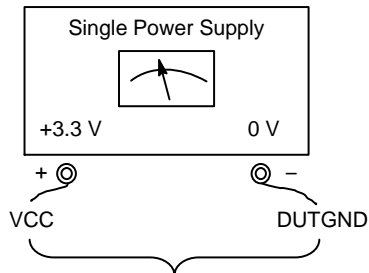

**Figure 3. Single Power Supply Configuration**

### HCSL Output Loading/Termination

HCSL outputs are typically loaded and terminated with a series resistor ( $R_{Series}$ ) = 33-Ω and 50-Ω to ground. This can be easily accomplished by connecting the HCSL outputs to the 50-Ω internal impedance in the oscilloscope. There are  $R_{Series}$  33-Ω termination resistors installed for each HCSL output.

### Output Enables – OE#

The OE# pins default Low when left open and will enable the outputs. To disable the outputs, connect the OE# pin to VDD.

### CLK\_IN & CLK\_IN#

The CLK\_IN and CLK\_IN# inputs can be driven by a signal generator through the SMA connectors provided. To terminate the signal generator, 50-Ω resistors to GND are installed on the board.

### Quick Start Lab Set-Up User's Guide

#### Test and Measurement Procedures

1. Connect TP1 (VCC) to the positive power supply.
2. Connect TP2 (DUTGND), TP3 (Exposed Pad) or TP4 (SMAGND) to GND power supply; they are all connected together.
3. Connect the outputs of the signal generator to the CLK\_IN and CLK\_IN# inputs with 50-Ω cables. There are 50-Ω resistors installed and connected to GND to terminate the outputs of the signal generator.
4. Connect the DIF\_n and DIF\_n# outputs to the appropriate 50-Ω oscilloscope head/channel. The board does not have 50-Ω output termination, thus use of the 50-Ω scope head is required. As an option, 50-Ω resistors can be carefully installed on each output on the board, and then use of a high impedance probe is required to measure outputs.

# NB3L202KMNGEVB

## Power-Up Sequence

1. Turn on DUT power supply.
2. Setup the signal generator output levels and frequency for the CLK\_IN & CLK\_IN# inputs.  
For differential HCSL inputs,  $V_{IL} = 0\text{ V}$  and  $V_{IH} = 700\text{ mV}$ .
3. Monitor DIF\_n & DIF\_n# outputs on the oscilloscope.

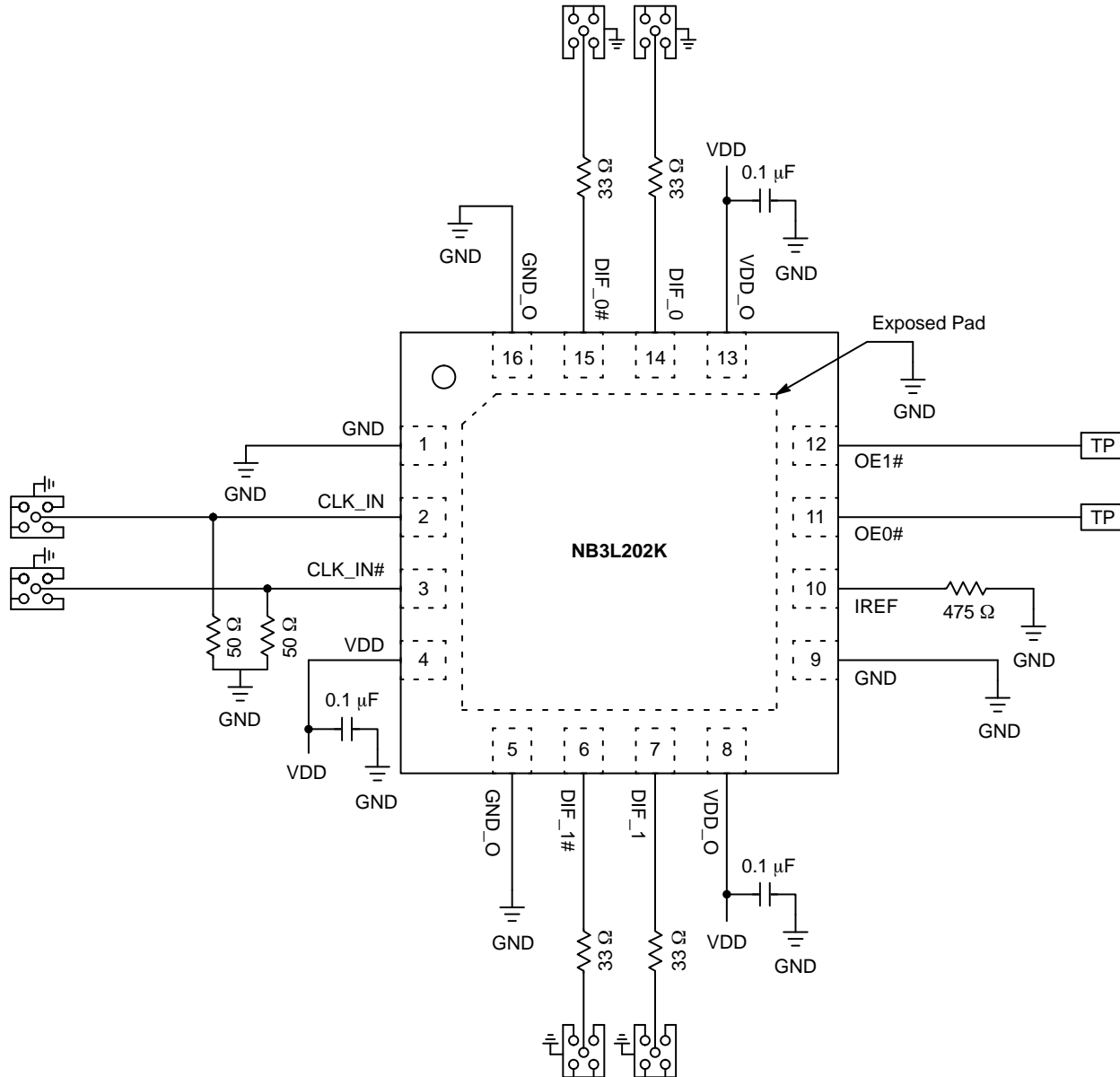

Figure 4. NB3L202KGEVB Schematic

# NB3L202KMNGEVB

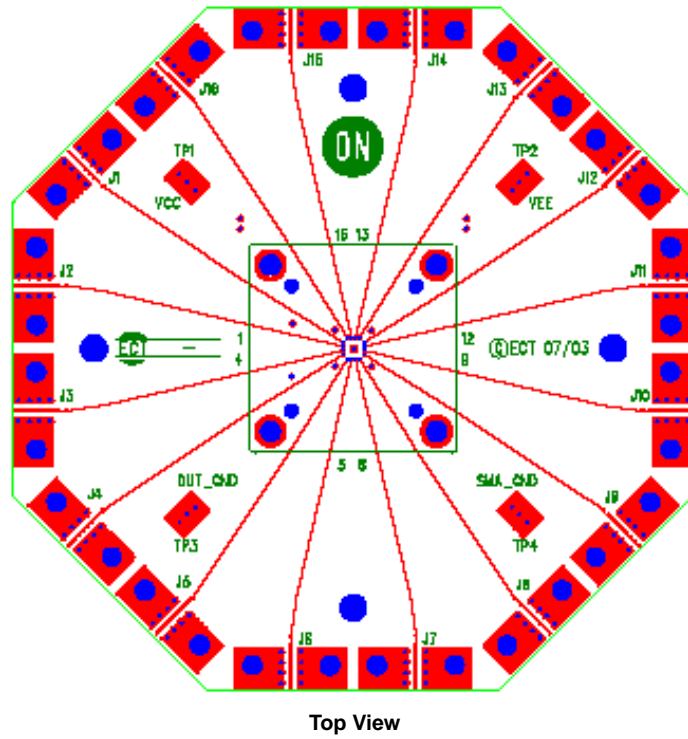

Figure 5. NB3L202KGEVB On-board Resistor Locations

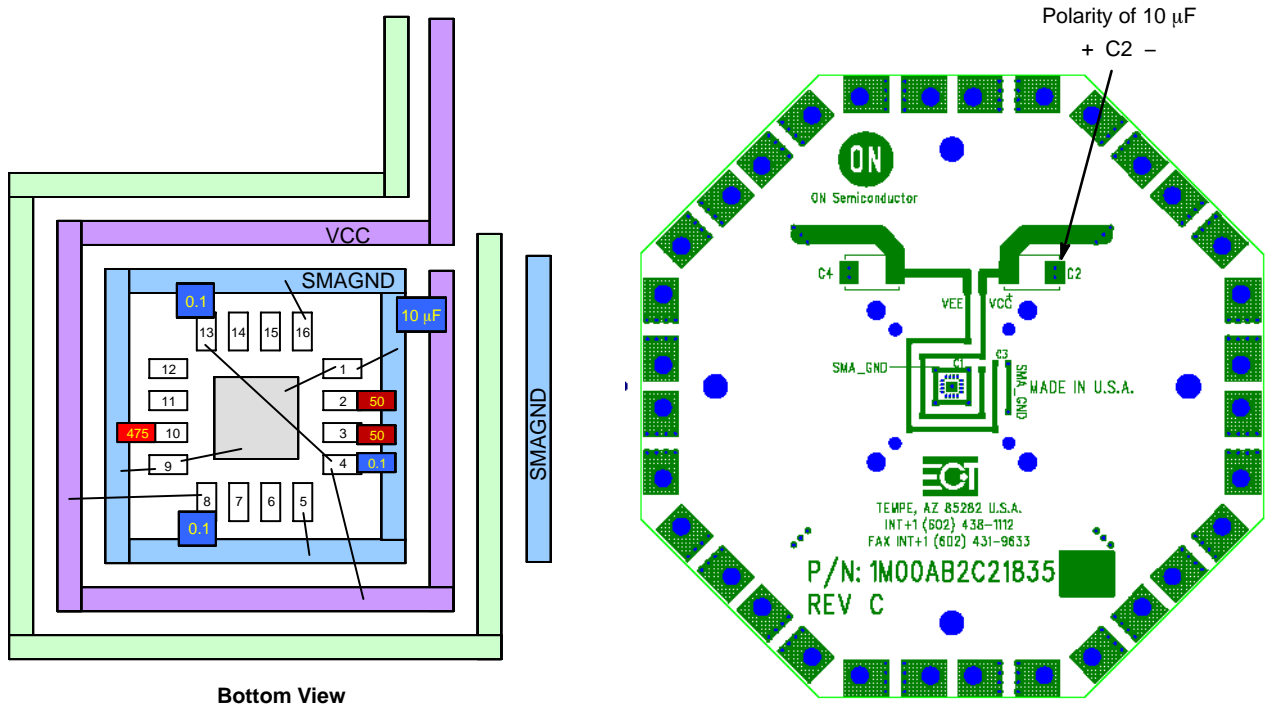



Figure 6. Configuration for NB3L202K

# NB3L202KMNGEVB

**Table 2. BILL OF MATERIALS**

Components	Qty.	Description	Manufacturer	Part Number
SMA Connector	6	SMA Connector, Side Launch, Gold Plated	Johnson	142-0701-801
Surface Mount Test Points	4	SMT Miniature Test Point	Keystone*	5015
Chip Capacitor	3	0.1 $\mu$ F $\pm$ 10% 0603	AVX Corporation*	0402ZD104KAT2A Digi-Key 478-1129-1-ND
Chip Capacitor	1	10 $\mu$ F $\pm$ 10%	AVX Corporation*	
Chip Resistor	2	50- $\Omega$ $\pm$ 1% 0603 Precision Thick Film Chip Resistor	Vishay	FC0603-50BFTR-ND
Chip Resistor	4	33- $\Omega$ 0402 Chip Resistor	Panasonic	
Chip Resistor	1	475- $\Omega$ 0402 Precision Thick Film Chip Resistor	Vishay	
Evaluation Board	1	QFN 16 Evaluation Board	ON Semiconductor	ECLQFN16EVB
Device Under Test	1	DUT	ON Semiconductor	NB3L202KMNG

\*Components are available through most distributors, i.e. [www.newark.com](http://www.newark.com), [www.digikey.com](http://www.digikey.com).

ON Semiconductor and the  are registered trademarks of Semiconductor Components Industries, LLC (SCILLC) or its subsidiaries in the United States and/or other countries. SCILLC owns the rights to a number of patents, trademarks, copyrights, trade secrets, and other intellectual property. A listing of SCILLC's product/patent coverage may be accessed at [www.onsemi.com/site/pdf/Patent-Marking.pdf](http://www.onsemi.com/site/pdf/Patent-Marking.pdf). SCILLC reserves the right to make changes without further notice to any products herein. SCILLC makes no warranty, representation or guarantee regarding the suitability of its products for any particular purpose, nor does SCILLC assume any liability arising out of the application or use of any product or circuit, and specifically disclaims any and all liability, including without limitation special, consequential or incidental damages. "Typical" parameters which may be provided in SCILLC data sheets and/or specifications can and do vary in different applications and actual performance may vary over time. All operating parameters, including "Typicals" must be validated for each customer application by customer's technical experts. SCILLC does not convey any license under its patent rights nor the rights of others. SCILLC products are not designed, intended, or authorized for use as components in systems intended for surgical implant into the body, or other applications intended to support or sustain life, or for any other application in which the failure of the SCILLC product could create a situation where personal injury or death may occur. Should Buyer purchase or use SCILLC products for any such unintended or unauthorized application, Buyer shall indemnify and hold SCILLC and its officers, employees, subsidiaries, affiliates, and distributors harmless against all claims, costs, damages, and expenses, and reasonable attorney fees arising out of, directly or indirectly, any claim of personal injury or death associated with such unintended or unauthorized use, even if such claim alleges that SCILLC was negligent regarding the design or manufacture of the part. SCILLC is an Equal Opportunity/Affirmative Action Employer. This literature is subject to all applicable copyright laws and is not for resale in any manner.

## PUBLICATION ORDERING INFORMATION

### LITERATURE FULFILLMENT:

Literature Distribution Center for ON Semiconductor  
19521 E. 32nd Pkwy, Aurora, Colorado 80011 USA  
**Phone:** 303-675-2175 or 800-344-3860 Toll Free USA/Canada  
**Fax:** 303-675-2176 or 800-344-3867 Toll Free USA/Canada  
**Email:** [orderlit@onsemi.com](mailto:orderlit@onsemi.com)

**N. American Technical Support:** 800-282-9855 Toll Free  
USA/Canada  
**Europe, Middle East and Africa Technical Support:**  
Phone: 421 33 790 2910  
**Japan Customer Focus Center**  
Phone: 81-3-5817-1050

**ON Semiconductor Website:** [www.onsemi.com](http://www.onsemi.com)

**Order Literature:** <http://www.onsemi.com/orderlit>

For additional information, please contact your local Sales Representative