

Connector - SACC-MINMS-3CON-PG 9 - 1521287

Please be informed that the data shown in this PDF Document is generated from our Online Catalog. Please find the complete data in the user's documentation. Our General Terms of Use for Downloads are valid (<http://phoenixcontact.com/download>)



Connector, 3-position, Plug straight 7/8"-16UNF, Screw connection, knurl material: Zinc die-cast, nickel-plated, cable gland Pg9, external cable diameter 6 mm ... 8 mm, Contact 1 leading

Why buy this product

- Safe use in the field, thanks to a high degree of protection
- Flexible: connectors for on-site assembly
- Screw connection: proven connection technology for a large selection of different conductors

RoHS

Key Commercial Data

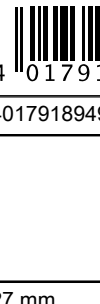
Packing unit	1 STK
GTIN	 4 017918 949747
GTIN	4017918949747

Technical data

Dimensions

Diameter housing	27 mm
Length	83 mm
External cable diameter	6 mm ... 8 mm
Stripping length of the sheath	30 mm
Stripping length of the individual wire	7 mm

Ambient conditions

Ambient temperature (operation)	-25 °C ... 85 °C (Plug / socket)
Degree of protection	IP67

General

Rated current at 40°C	12 A
Rated voltage	300 V
Number of positions	3

Connector - SACC-MINMS-3CON-PG 9 - 1521287

Technical data

General

Insulation resistance	≥ 100 MΩ
Coding	A - standard
Status display	No
Overvoltage category	III
Degree of pollution	3
Connection method	Screw connection
Conductor cross section	0.34 mm ² ... 1.5 mm ² (without ferrule)
	0.34 mm ² ... 1.5 mm ² (with ferrule)
	0.34 mm ² ... 1.5 mm ² (solid)
Conductor cross section AWG	22 ... 16 (without ferrule)
	22 ... 16 (with ferrule)
Insertion/withdrawal cycles	≥ 100
Torque	0.8 Nm (7/8" connectors)
	0.4 Nm (Screw terminal blocks)
	0.8 Nm ... 1 Nm (Pressure screw)
Tightening torque	Screw plug insert with sleeve housing as far it will go
Assembly instructions	The wires can be connected both with ferrules and without ferrules

Material

Flammability rating according to UL 94	HB
Contact material	CuZn
Contact surface material	Au
Contact carrier material	PUR / PA 6.6
Material of grip body	PBT
Material, knurls	Zinc die-cast, nickel-plated

Standards and Regulations

Connection in acc. with standard	CUL
Flammability rating according to UL 94	HB

Environmental Product Compliance

REACH SVHC	Lead 7439-92-1
China RoHS	Environmentally Friendly Use Period = 50
	For details about hazardous substances go to tab "Downloads", Category "Manufacturer's declaration"

Drawings

Connector - SACC-MINMS-3CON-PG 9 - 1521287

Schematic diagram

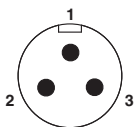

Pin assignment, plug, 7/8"-16UNF, 3-pos., view of male side

Functional drawing

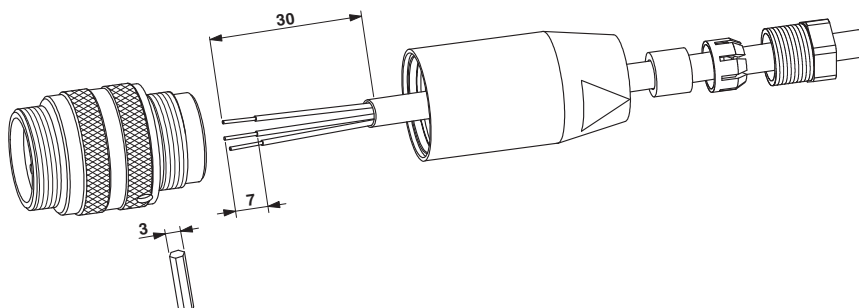

Dimensional drawing

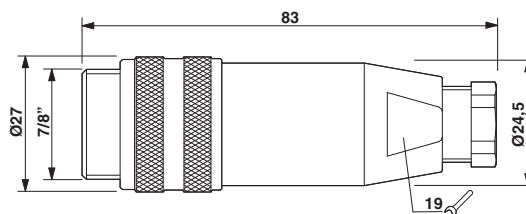

Plug 7/8"-16UNF, straight, Pg9

Approvals

Approvals

Approvals

UL Recognized / cUL Recognized / EAC / cULus Recognized

Ex Approvals

Approval details

UL Recognized		http://database.ul.com/cgi-bin/XYV/template/LISEXT/1FRAME/index.htm	FILE E 221474
Nominal voltage UN	600 V		
Nominal current IN	12 A		

Connector - SACC-MINMS-3CON-PG 9 - 1521287

Approvals

cUL Recognized		http://database.ul.com/cgi-bin/XYV/template/LISEXT/1FRAME/index.htm	FILE E 221474
Nominal voltage UN		600 V	
Nominal current IN		12 A	

EAC		RU C- DE.AI30.B.01102
-----	---	--------------------------

cULus Recognized		http://database.ul.com/cgi-bin/XYV/template/LISEXT/1FRAME/index.htm
------------------	---	---

Phoenix Contact 2018 © - all rights reserved
<http://www.phoenixcontact.com>

PHOENIX CONTACT GmbH & Co. KG
Flachsmarktstr. 8
32825 Blomberg
Germany
Tel. +49 5235 300
Fax +49 5235 3 41200
<http://www.phoenixcontact.com>