

DELPHI SERIES



Delphi Series DIM, 300W Dual Input Power Processing DC/DC Power Modules

The Delphi DIM series, 300W dual redundant input power processing isolated DC/DC converter is the latest offering from a world leader in power system and technology and manufacturing — Delta Electronics, Inc. This product family provides up to 300 watts of power in an industry standard footprint and pinout. The DIM series is designed to simplify the task and reduce the board space of implementing dual redundant, hot swappable 48Vdc power distribution with EMI filtering and inrush current limiting for an ATCA (Advanced Telecommunications Computing Architecture) or other telecom boards. In addition to processing the dual redundant 48V bus, the DIM module also provides isolated auxiliary 3.3V (8W), and/or 5V (100mA) BLUE_LED power for other housekeeping functions. With creative design technology and optimization of component placement, these converters possess outstanding electrical and thermal performances, as well as extremely high reliability under highly stressful operating conditions. All models are fully protected from abnormal input/output voltage, current, and temperature conditions. The Delphi DIM series converters meet all safety requirements with basic insulation.

FEATURES

- ♦ High efficiency 98% @ 48Vin, 300W
- ♦ Size: 70.6x36.8x12.7mm (2.78"x1.45"x0.5")
- ♦ Standard footprint
- ♦ Industry standard pin out
- ♦ Input OVP, UVLO, Output OCP, OTP
- ♦ 8W (3.3Vdc) of isolated management power for module self or other housekeeping functions
- ♦ 5V/100mA BLUE_LED power
- ♦ Input OR'ing for the A/B dual input power feeds as well as A/B Enable signals
- ♦ Inrush protection and hot swap capability
- ♦ Integral EMI filter designed for the ATCA board to meet CISPR Class B
- ♦ Independent 72Vdc output for charging the external holdup capacitors resulting in significant board real estate savings and bleed resistor power dissipation
- ♦ ISO 9001, TL 9000, ISO 14001, QS9000, OHSAS18001 certified manufacturing facility
- ♦ UL/cUL 60950-1 (US & Canada).

OPTIONS

- ♦ 3.3V management Power

APPLICATIONS

- ♦ Telecom / Datacom
- ♦ Wireless Networks
- ♦ Optical Network Equipment
- ♦ Server and Data Storage
- ♦ Industrial / Testing Equipment

TECHNICAL SPECIFICATIONS

(T_A=25°C, airflow rate=300 LFM, V_{in}=-48Vdc, nominal V_{out} unless otherwise noted;)

PARAMETER	NOTES and CONDITIONS	DIM3R3300 (Standard)			
		Min.	Typ.	Max.	Units
ABSOLUTE MAXIMUM RATINGS					
Input Voltage					
Continuous		0	-48	-75	Vdc
Transient	10μs			-100	Vdc
Operating Case Temperature	Please refer to Fig.13 for the measuring point, Tc	-40		117	°C
Storage Temperature		-55		125	°C
ISOLATION					
Input to MGMT_PWR Output Voltage				1500	Vdc
Input to SHELF_GND Voltage				1500	Vdc
Input to LOGIC_GND Voltage				1500	Vdc
LOGIC_GND to SHELF_GND Insulation Resistance	100Vdc	10			MΩ
GENERAL SPECIFICATIONS					
Calculated MTBF	Pin=300W, Vin=-48V		1,955		Mhours
Over-Temperature Shutdown	Refer to Figure 13 for the measuring point, Tc		130		°C
Weight			27		grams
MAIN INPUT (DUAL FEED) CHARACTERISTICS					
Operation Input Voltage Range		-36		-75	V
Input UVLO					
Turn-On Voltage Threshold	VRTN_OUT open load	-33.2	-34.6	-36	Vdc
Turn-Off Voltage Threshold	VRTN_OUT open load	-30.2	-31.6	-33	Vdc
Input OVP					
Turn-On Voltage Threshold	VRTN_OUT open load	-78	-79.8	-81.5	Vdc
Turn-Off Voltage Threshold	VRTN_OUT open load	-80	-81.8	-83.5	Vdc
Off Converter Input Current	Vin < UVLO voltage		10		mA
Maximum Input Current	Pin=300W, Vin=0 to -75V			9.5	A
POWER & MAIN OUTPUT (-48V output)					
Input Power, Maximum Allowable				300	W
Efficiency	Pin=300W, MGMT_PWR/BLUE_LED_PWR no load	97	98		%
Efficiency	Pin=300W, MGMT_PWR=8W, BLUE_LED_PWR=0.5W	96	97		%
Total Power Dissipation	Pin=300W, MGMT_PWR=8W, BLUE_LED_PWR=0.5W		10		W
Management Power, Maximum Deliverable				8	W
Module Standby Current					
Vin=-36V,	Pout=0W, MGMT_PWR=0W, BLUE_LED_PWR=0W		80		mA
Vin=-48V,			45		mA
Vin=-75V,			40		mA
Main Output External Output Filter Capacitance		200		330	μF
HOT SWAP					
Inrush Transient					
0-0.9mS	Pin=300W, Vin=-75V, MGMT_PWR=0, BLUE_LED_PWR=0W			42.5	A
0.9-3mS				17	A
3-100mS				8.5	A
INPUT A/B FEED LOSS / FUSE ALARM					
Alarm ON Input Voltage Threshold		-36	-36.8	-37.9	%
Alarm Off Input Voltage Threshold		-37.3	-37.5	-37.7	%
Opto Transistor Collector to Emitter Voltage				40	Vdc
Opto Transistor Collector to Emitter Dark Current	Opto Diode current, Id = 0A			100	nA
Opto Transistor Collector Saturation Voltage				0.3	V
HOLD UP CAPACITANCE INTERFACE					
Hold-up Capacitor Voltage Accuracy		-70	72	-74	V
Hold-up Capacitor Charge Current			24		mA
Minimum Hold-up Capacitance (C_HOLD)		47			μF
72V_CAP ON Input Voltage Threshold		-36	-37	-38	V
72V_CAP OFF Input Voltage Threshold		-36.6	-37.6	-38.6	V

TECHNICAL SPECIFICATIONS

($T_A=25^{\circ}\text{C}$, airflow rate=300 LFM, $V_{in}=48\text{Vdc}$, nominal V_{out} unless otherwise noted;)

PARAMETER	NOTES and CONDITIONS	DIM3R3300 (Standard)			
		Min.	Typ.	Max.	Units
MANAGEMENT POWER					
Operating Input Voltage	Continuous	-36	-48	-75	
Output Voltage Set-point	$I(\text{MGMT_PWR})=1.25\text{A}$	-1.5		+1.5	%Vo
Output Voltage (total)	Over V_{in} , load, temperature	-3		+3	%Vo
Output Regulation					
Line Regulation	$V_i = V_{i,\text{min}}$ to $V_{i,\text{max}}$		0.05	0.2	%Vo
Load Regulation	$I_o = I_{o,\text{min}}$ to $I_{o,\text{max}}$		0.05	0.2	%Vo
Temperature Regulation	$T_a = T_{a,\text{min}}$ to $T_{a,\text{max}}$			1	%Vo
Output Voltage Overshoot				3	%Vo
Back-Drive Current	NA		0		mA
Switching Frequency			450		KHz
MANAGEMENT POWER (3.3V)					
Output Ripple and Noise					
RMS	10 μF Tan cap and 1 μF ceramic cap			20	mV
Peak-to-peak	5Hz to 20 MHz bandwidth			70	mV
Output Current	5Hz to 20MHz bandwidth	0		2.4	A
Over Current Protection	Hiccup mode	3		6.5	A
Output Short-circuit Current (RMS)			2.2		A
Hiccup Mode Restart Time			10		mS
Output Over Voltage Protection	Voltage limitation mode		5	5.4	V
Dynamic Response (20 MHz bandwidth)	load step is 50%~100%~50%, slew rate is 0.1A/ μS				
Peak Deviation			3	5	%Vo
Settling Time			800		μS
Turn-On Delay Times	$I(\text{MGMT_PWR})=2.5\text{A}$		25		mS
Turn-On Rising Times	$I(\text{MGMT_PWR})=2.5\text{A}$		5		mS
External Load Capacitance	$I_o = I_{o,\text{min}}$ to $I_{o,\text{max}}$			1000	μF
BLUE LED POWER 5V					
Operating Input Voltage	Continuous	-36	-48	-75	Vdc
Total Output Voltage Range		4.9	5	5.1	Vdc
Output Regulation		-3		3	%Vo
Output Ripple and Noise			5		mV
Operating Output Current Range		0		0.1	A

DIM3R3 INTERNAL BLOCK DIAGRAM

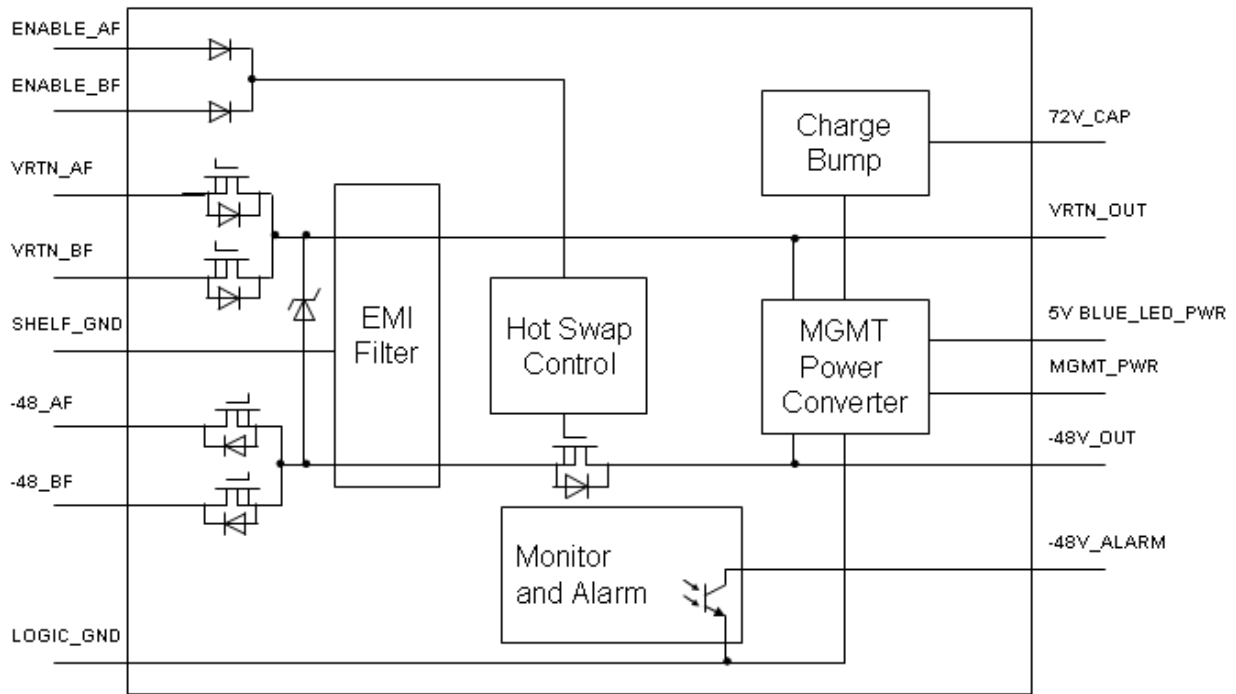

PIN FUNCTIONS

PIN NO.	PIN NAME	DESCRIPTION
1	-48_AF	-48V_A Feed (Externally Fused)
2	-48_BF	-48V_B Feed (Externally Fused)
3	VRTN_AF	VRTN_AF Feed (Externally Fused)
4	VRTN_BF	VRTN_BF Feed (Externally Fused)
5	ENABLE_AF	ENABLE_AF Feed (Externally Fused) (Short Pin, connected to VRTN_AF on the back plane)
6	ENABLE_BF	ENABLE_BF Feed (Externally Fused) (Short Pin, connected to VRTN_BF on the back plane)
7	SHELF_GND	Shelf / Chassis / Safety Ground
8	72V_CAP	Holdup/Bulk capacitor output voltage (Negative Connection to -48V_OUT)
9	-48V_OUT	OR'd and Inrush Protected -48V Output Bus
10	MGMT_PWR	3.3V Isolated Management Power Output (reference to LOGIC_GND)
11	5V BLUE_LED_PWR	This pin is optional for 5V Isolated Blue LED Power output (reference to LOGIC_GND)
12	LOGIC_GND	Logic / Secondary / Isolated Ground
13	-48V_ALARM	Opto-isolated -48V A/B Feed Loss or Open Fuse Alarm (reference to LOGIC_GND)
14	VRTN_OUT	OR'd and Inrush Protected VRTN Output Bus

ELECTRICAL CHARACTERISTICS CURVES

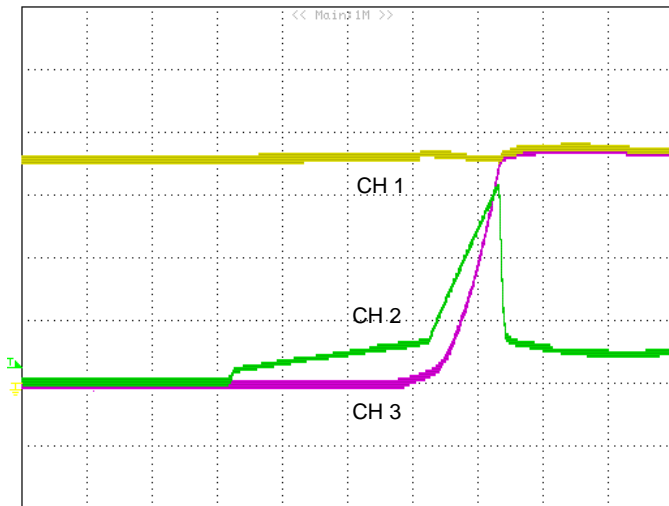

Figure 1: Input voltage turn-on threshold (2mS/div):
 CH1: Vin (VRTN_AF reference to -48V_AF, 10V/div).
 CH2: lin (-48V_AF, 2A/div).
 CH3: VRTN_OUT reference to -48V_OUT (10V/div).

Test conditions:

- (1) Feed A=37Vdc (Von slew rate= 0.1V/ms); Feed B=0Vdc
- (2) I(VRTN_OUT)=1A, I(3.3V)=0A, I(5V BLUE_LED_PWR)=0A.
- (3) C2=220uF, C_hold=220uF

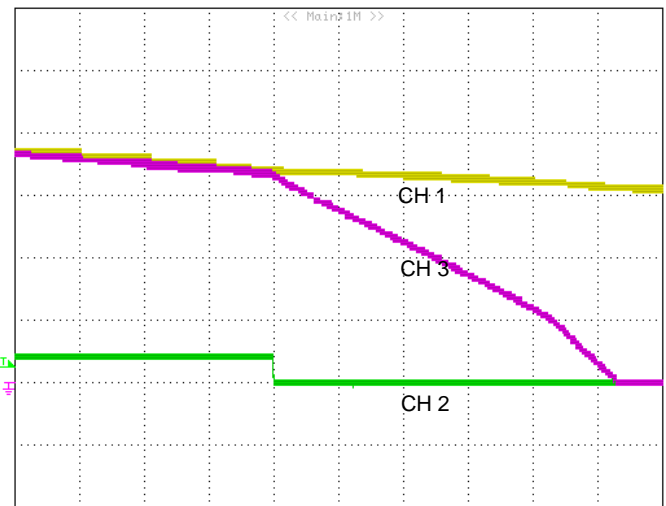

Figure 2: Input voltage turn-off threshold (2mS/div):
 CH1: Vin (VRTN_AF reference to -48V_AF, 10V/div).
 CH2: lin (-48V_AF, 2A/div).
 CH3: VRTN_OUT reference to -48V_OUT (10V/div).

Test conditions:

- (1) Feed A=37Vdc (Voff slew rate= 0.3V/ms); Feed B=0Vdc
- (2) I(VRTN_OUT)=1A, I(3.3V)=0A, I(5V BLUE_LED_PWR)=0A.
- (3) C2=220uF, C_hold=220uF

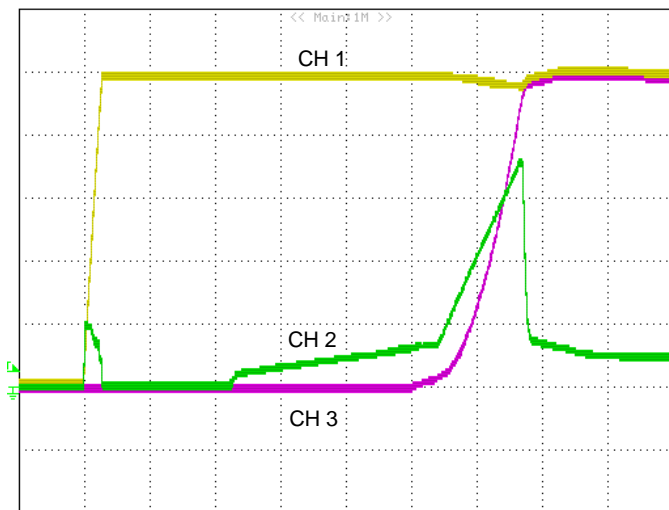

Figure 3: Inrush current (2mS/div):
 CH1: Vin (VRTN_AF reference to -48V_AF, 10V/div).
 CH2: lin (-48V_AF, 2A/div).
 CH3: VRTN_OUT reference to -48V_OUT (10V/div).

Test conditions:

- (1) Feed A=48Vdc, Feed B=0Vdc.
- (2) I(VRTN_OUT)=1A, I(3.3V)=0A, I(5V BLUE_LED_PWR)=0A.
- (3) C2=220uF, C_hold=220uF

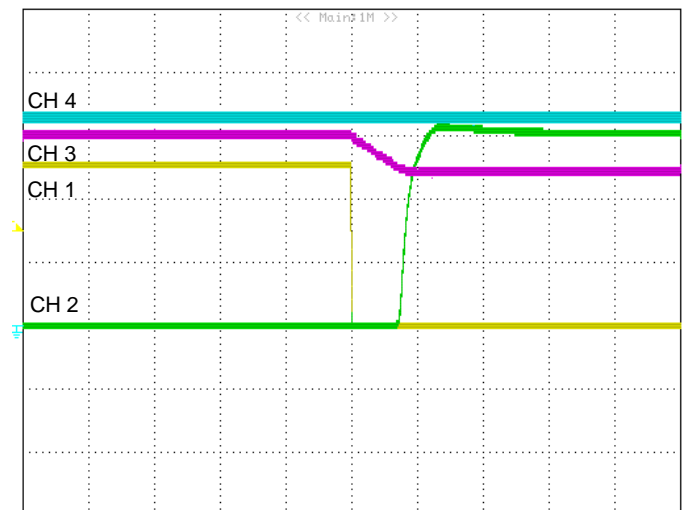

Figure 4: Oring for one feed loss (500µS/div):
 CH1: linA (2A/div)
 CH2: linB (2A/div).
 CH3: VRTN_OUT reference to -48V_OUT (10V/div).
 CH4: VMGMT_PWR (1V/div).

Test conditions:

- (1) Feed A=60V, Feed B=48V;
- (2) Q48SH12025: I(12 Vout)=22.5A, I(3.3V)=2.5A, I(5V BLUE_LED_PWR)=0A.
- (3) C2=220uF, C_hold=220uF

ELECTRICAL CHARACTERISTICS CURVES

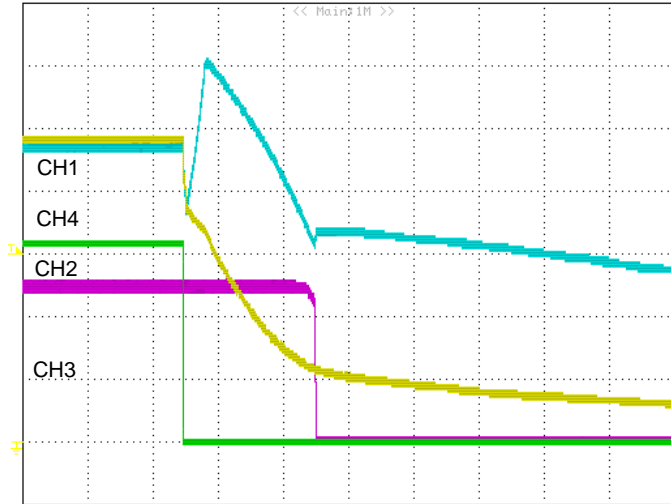

Figure 5: Hold up performance (5mS/div):
 CH1: Vin (VRTN_AF reference to -48V_AF, 10V/div).
 CH2: Iin (2A/div).
 CH3: 12V Vout (5V/div).
 CH4: VRTN_OUT reference to -48V_OUT (10V/div).

Test conditions:

- (1) Feed A=48Vdc; Feed B=0Vdc
- (2) Q48SH12025: I(12V Out)=22.5A, I(3.3V)=2.5A, I(5V BLUE_LED PWR)=0A.
- (3) C2=220uF, C_hold=470uF X4

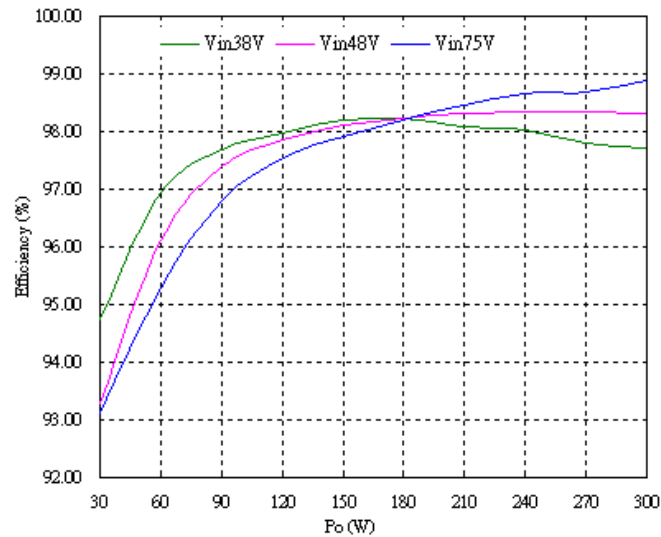

Figure 7: Efficiency vs. load current for minimum, nominal, and maximum input voltage at 25°C:

Test conditions:

- (1) I(MGMT_PWR)=0A; I(5V BLUE_LED PWR)=0A;
- (2) C2=220uF, C_hold=220uF
- (3) Po(VRTN_OUT ref to -48V_OUT)from 30W to 300W

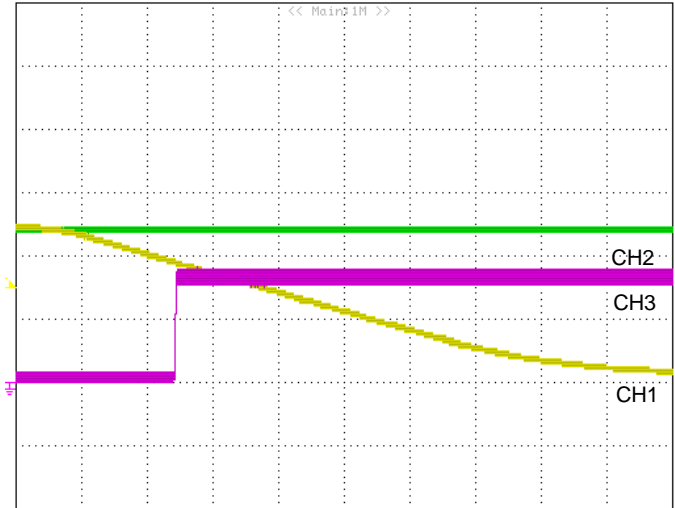

Figure 6: -48V_ALARM with loss of Feed (20mS/div):
 CH1: VinA (VRTN_AF reference to -48V_AF, 20V/div).
 CH2: VinB (VRTN_BF reference to -48V_BF, 20V/div).
 CH3: -48V_ALARM (2V/div)

Test conditions:

- (1) Feed A turn off from 48Vdc; Feed B=48Vdc.
- (2) Q48SH12025: I(12V Out)=22.5A, I(3.3V)=2.5A, I(5V BLUE_LED PWR)=0A.
- (3) C2=220uF, C_hold=220uF



Figure 8: MGMT_PWR (3.3V) and BLUE_LED_PWR (5V) start up waveform (10mS/div):

CH1: VinA (VRTN_AF referenced to -48V_AF, 50V/div).
 CH2: V(MGMT_PWR) (1V/div);
 CH3: V(5V BLUE_LED_PWR) (1V/div)

Test conditions:

- (1) Feed A=48Vdc; Feed B=0Vdc
- (2) I(VRTN_OUT)=1A, I(3.3V)=2.5A, I(5V BLUE_LED PWR)=0.1A
- (3) C2=220uF, C_hold=220uF

ELECTRICAL CHARACTERISTICS CURVES

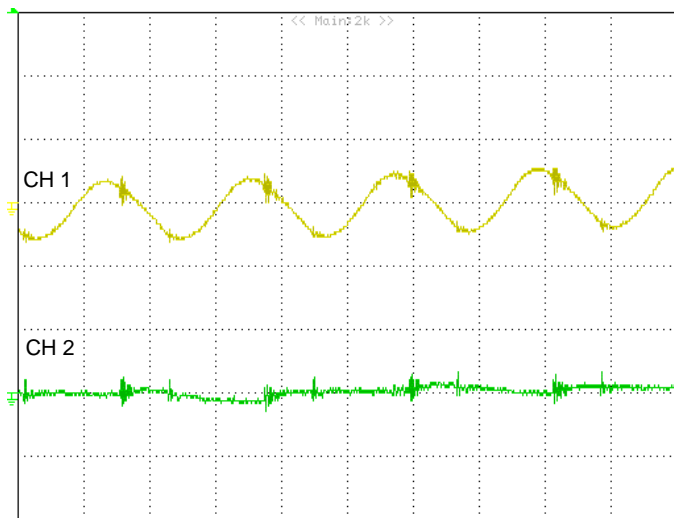

Figure 9: MGMT_PWR (3.3V) and BLUE_LED_PWR (5V) output ripple/noise (2uS/div):

CH1: Vo, MGMT_PWR (20mV/div).

CH2: Vo, 5V BLUE_LED_PWR (20mV/div).

Test conditions:

- (1) Feed A=48Vdc; Feed B=0Vdc
- (2) $I(3.3V)=1.25A$, $I(5V\ BLUE_LED_PWR)=0.1A$
 $I(VRTN_OUT)=6.3A$
- (3) $C2=220\mu F$, $C_hold=220\mu F$

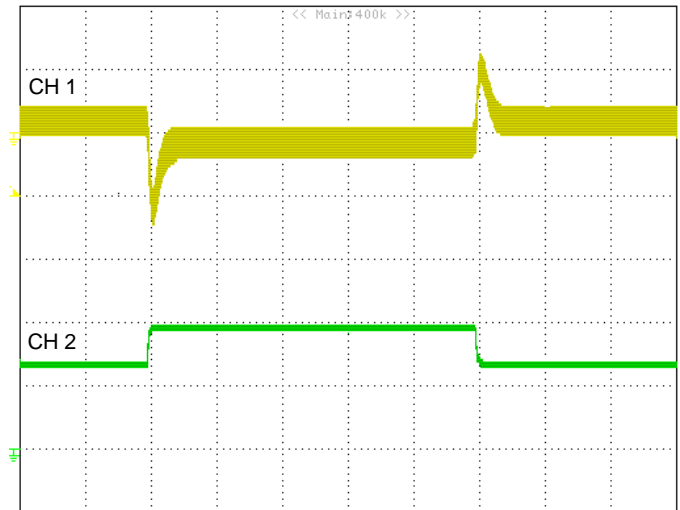

Figure 10: MGMT_PWR (3.3V) dynamic response (1mS/div):

CH1: Vo, MGMT_PWR (50mV/div).

CH2: Io, MGMT_PWR (1A/div)

Test conditions:

- (1) Feed A=48Vdc; Feed B=0Vdc
- (2) 3.3V MGMT_PWR load current (50%-75%-50% of $I_{o,max}$,
 $di/dt = 0.1A/\mu s$), $I(VRTN_OUT)=6.3A$.
- (3) $C2=220\mu F$, $C_hold=220\mu F$

APPLICATION CIRCUITS

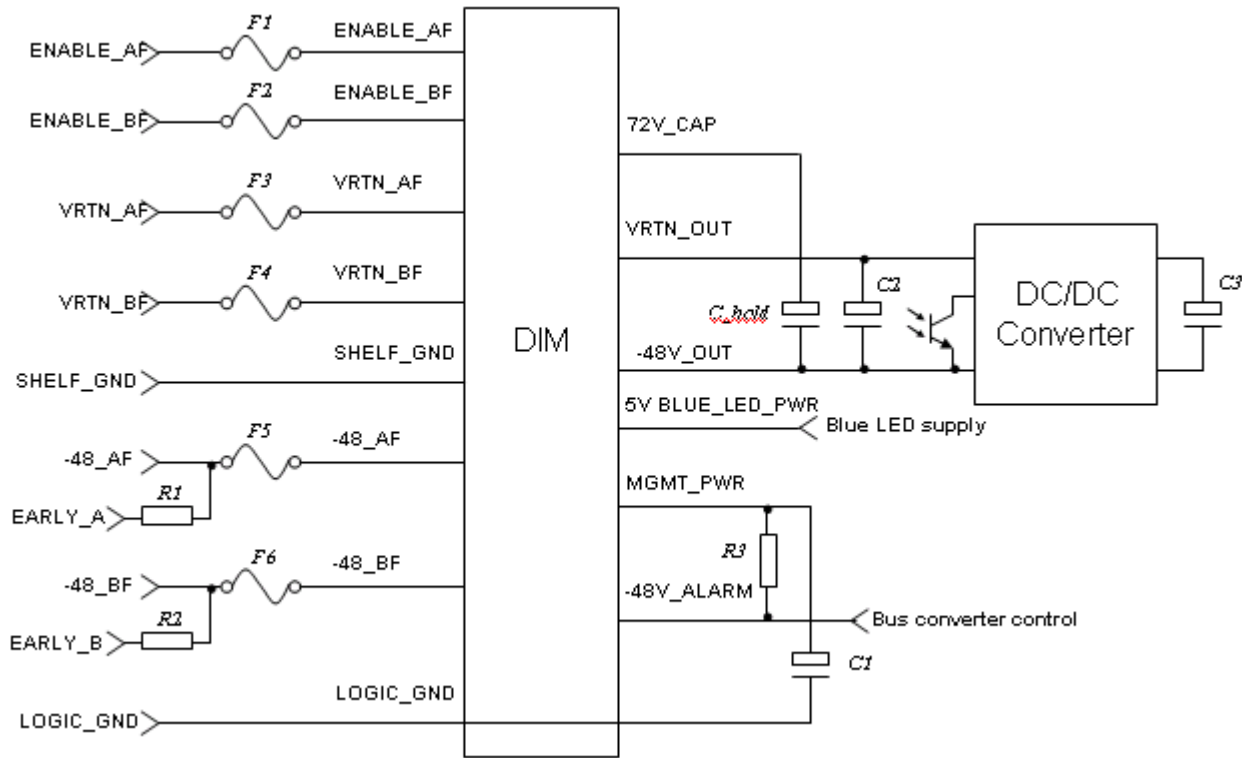

TYPICAL VALUES FOR ABOVE COMPONENTS:

POSITION	VALUE	NOTE
F1,F2	1A, FUSE	
F3,F4	15A, FUSE	
F5,F6	15A, FUSE	
R1,R2	15Ω, RESISTOR	
R3	7.5KΩ, RESISTOR	
C1	22μF, CAP	No additional output capacitors are required, this cap are highly recommended to reduce the switching ripple and noise.
C2	200~330μF, CAP	
C3		Defined by DC/DC converter application note
C_HOLD	$\frac{2 * Power * T_HLDP}{72V^2 - Vth^2}$	for the definition of parameters, please see page 10

FEATURES AND DESIGN CONSIDERATIONS

Introduction

The DIM3R3/050 module is designed to simplify the task and reduce the board space of an ATCA (Advanced Telecommunications Computing Architecture) power entry distribution requirements in the system board.

The main functionality of the module is to provide dual, redundant -48V A/B Feed OR'ing, inrush protection for hot swap capability, EMI filtering to attenuate the noise generated by the downstream DC/DC converters, and a 72V output voltage for charging the holdup capacitor. The module also has a management power supply which provides an 8W, 3.3V management power and/or a 5V/100mA output (optional) to power the blue LED per PICMG 3.0 requirement.

The module provides A/B feed/fuse open alarm, over current protection, over voltage protection, and over temperature protection. It also provides input under voltage lock-out and input reverse polarity protection.

A/B Feed OR'ing

To improve the total power distribution efficiency, four internal MOSFETs are used to function as the OR'ing diodes. A control circuit is designed to keep about 100mV voltage drop across MOSFET. During full load operation, the MOSFETs are fully turned on. During light load, the MOSFETs work under a high R_{ds(on)} condition. If the output current decreases to zero, the MOSFETs will be turned off. This design provides module a reverse voltage sustain function. The module shall not be damaged from reverse polarity connection in the event of mis-wiring of either input feeds at the shelf input terminals. Furthermore, a fast shut down circuit is designed for the negative current case. This design protects the common DC bus against hard short faults at the sourcing power supply output.

Hot Swap Functionality

The hot-swap function is designed to limit the inrush current charged to the bulk capacitor of the down stream bus converter. The current value and duration comply with the PICMG 3.0's Inrush Transient specs.

Although the inrush current for bulk capacitor is under control, special attentions need to be paid to the current for EMI filter because this circuit is in front of hot-swap circuit.

EMI Filtering

An internal EMI filter is designed for the ATCA board to meet the system conducted emission requirements of CISPR 22 Class B when used with Delta DC/DC converters.

Figure 17 shows the EMI performance of DIM3R3 when it worked with Delta power module Q48SH12025NRFA (36~75Vin, 12V/25A output Quarter brick). It meets CISPR 22 Class B requirement.

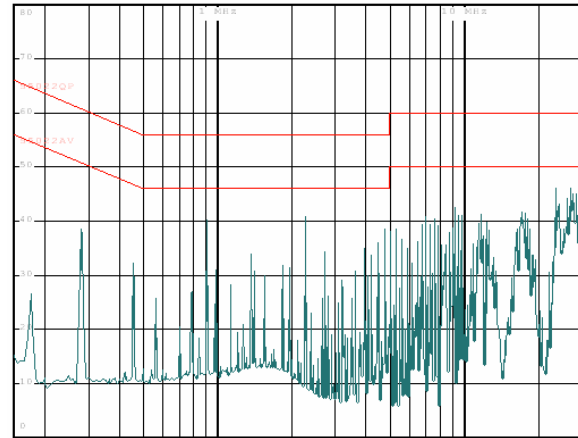

Figure 11: EMI test result with Q48SH12025NRFA:

Holdup Capacitor Charging Current (72V_CAP)

An off line holdup capacitor (C_HLDP) is needed to store energy for the holdup time requirement. C_HLDP is charged to 72V (+/- 3% tolerance). For a fixed energy storage requirement, high capacitor voltage reduces capacitor capacitance and size. A constant current circuit charges C_HLDP before its voltage reaches the high limitation and isolates it from power train circuit. The discharge switch will turn on if both A&B feeds have dropped below -38V (typical). C_HLDP will be connected to power train and provided the energy for system operation.

C_HLDP is calculated by the following equation:

$$C_{HLDP} = \frac{2 * Power * T_{HLDP}}{72V^2 - V_{th}^2}$$

Where Power is the input power to the downstream DC/DC converter; T_HLDP is the holdup time requirement; V_{th} is the minimum input voltage threshold of the downstream DC/DC converter.

FEATURES AND DESIGN CONSIDERATIONS (CONTINUED)

The PICMG 3.0's requirements for the 0 Vdc transient is 5mS with 50V/ms fall slew rate and 12.5 V/ms rise slew rate. This requirement will lead to a 9.3ms T_HLDP requirement assuming power is interrupted at -43Vdc (Vth).

Considering power output is 300W, Vth is 43V,

$$C_{HLDP} = \frac{2 * 300 * 9.3}{72^2 - 43^2} = 1672(\mu F)$$

When the input voltage is at the threshold of discharge, C_HLDP will go off line and the charge pump will recharge it to 72V.

The discharge resistor for C_HLDP is not required, because there is sufficient standby current in the module to bleed the holdup capacitors from 75V to 60V within 1 second as specified in the PICMG 3.0. Furthermore a bleed resistor will induce extra loss of the MOSFET of the charging circuit.

Over-Current Protection

DIM3R3/050 provides two over current protection levels to protect downstream DC/DC converter over power rating. When the downstream DC/DC converter over power rating and caused our output current exceeds the low current limit level, the current will be kept for a period of time before the module is shut down. After a fixed delay time, the module will try to restart. If the downstream DC/DC converter over power rating and caused our output current exceeds the high current limit level, the module will shut down immediately. Then it will go through the same restarting procedure.

A/B Feed / Fuse Alarm (-48V_ALARM)

The input feeds A and B are monitored. The module will send an opto-isolated signal if any of the feed is below the voltage threshold (typical 35V). Therefore, the loss of any A or B feed can be detected. The opto coupler transistor on state indicates a normal status and off state indicates a fault condition.

Input Under Voltage Lockout

The input under-voltage lockout prevents the module from being damaged by low input voltage. When the input voltage is lower than its threshold voltage, the module will be turned off. The lockout occurs between -33.3V to -35.3V.

Transient Over Voltage Protection

The PICMG 3.0 requires the module work normally under 200V/5μS and 100V/10μS input voltage transient. DIM3R3/050 can meet the requirement. An internal TVS with 80V/1500W peak pulse power rating will suppress the 200V transient voltage. For the 100V pulse voltage, the power train impedance will damp it below internal components rating without shut down the module. When input voltage of the module is higher than 81.8V, the module will be turned off. The module will restart when the input voltage drop down to 79.8V.

Management Power and Blue_LED Power

The module contains two isolated DC output. The first output provides up to 8W of 3.3V (DIM3R3) management power (reference to LOGIC_GND). This power is used to power the IPM controller for the ATCA board or to power up system controller for other applications. The second isolated output, 5V/100mA, is used to power the Blue LED per PICMG 3.0 requirement.

The management power is available as soon as the input voltage levels are within -36Vdc to -75Vdc. The output is short circuit and over voltage protected. The module is in a hiccup mode under an OCP or short output condition. The output voltage will keep constant under over voltage status. No additional output capacitors are required, but a 22μF tantalum/ceramic and a 0.01μF to 0.1μF ceramic capacitors are highly recommended to reduce the switching ripple and noise. Higher output capacitance may be required in case of large input line or output load transient conditions.

THERMAL CONSIDERATIONS

Thermal management is an important part of the system design. To ensure proper, reliable operation, sufficient cooling of the power module is needed over the entire temperature range of the module. Convection cooling is usually the dominant mode of heat transfer.

Hence, the choice of equipment to characterize the thermal performance of the power module is a wind tunnel.

Thermal Testing Setup

Delta's DC/DC power modules are characterized in heated vertical wind tunnels that simulate the thermal environments encountered in most electronics equipment. This type of equipment commonly uses vertically mounted circuit cards in cabinet racks in which the power modules are mounted.

The following figure shows the wind tunnel characterization setup. The power module is mounted on a test PWB and is vertically positioned within the wind tunnel. The space between the neighboring PWB and the top of the power module is constantly kept at 6.35mm (0.25").

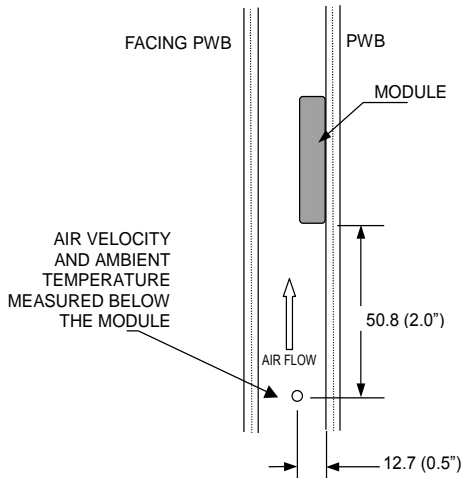

Note: Wind Tunnel Test Setup Figure Dimensions are in millimeters and (Inches)

Figure 12: Wind tunnel test setup

Thermal Derating

Heat can be removed by increasing airflow over the module. To enhance system reliability, the power module should always be operated below the maximum operating temperature. If the temperature exceeds the maximum module temperature, reliability of the unit may be affected.

THERMAL CURVES

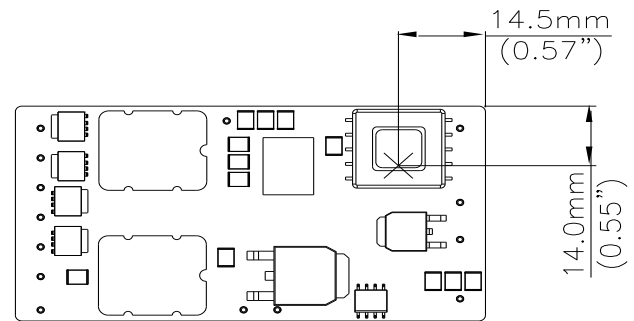

Figure 13: Temperature measurement location

* The allowed maximum hot spot temperature is defined at 117°C

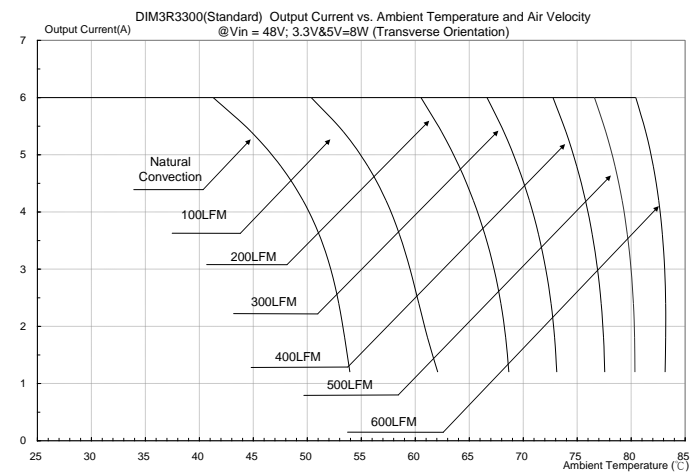

Figure 14: Output current vs. ambient temperature and air velocity @Vin=48V (Transverse Orientation, Pout2 = 8 W (Vout2=3.3V), Pout3 = 0.5 W (Vout3=5V)

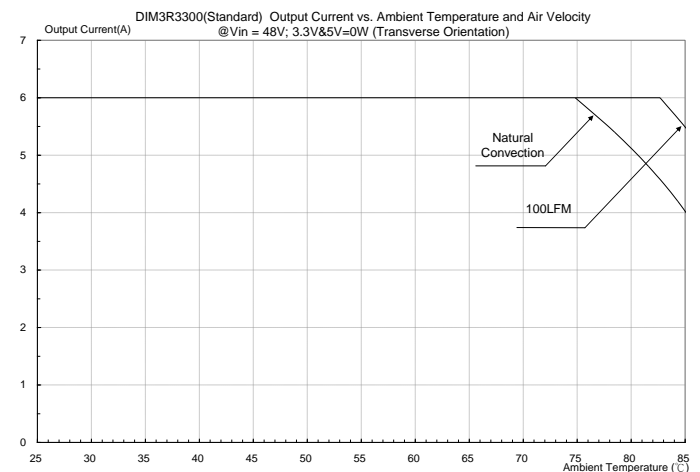
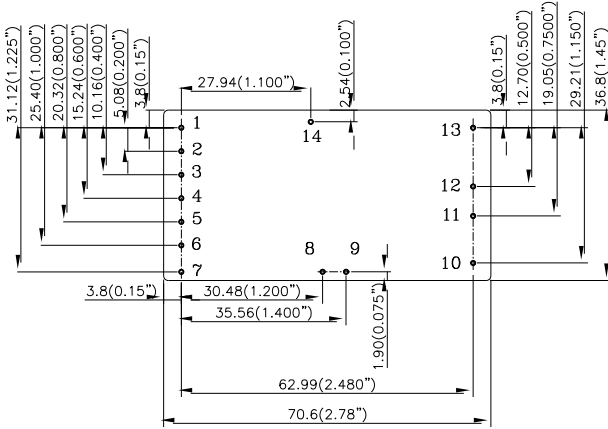
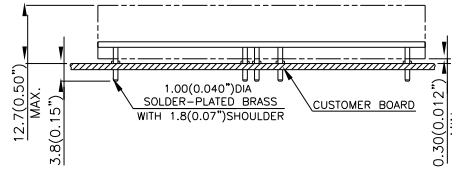

Figure 15: Output current vs. ambient temperature and air velocity @Vin=48V (Transverse Orientation, Pout2 = 0 W (Vout2=3.3V), Pout3 = 0 W (Vout3=5V)

MECHANICAL DRAWING



TOP VIEW



SIDE VIEW

PIN ASSIGNMENT

PIN NO.	FUNCTION
1	-48V_AF
2	-48V_BF
3	VRTN_AF
4	VRTN_BF
5	ENABLE_AF
6	ENABLE_BF
7	SHELF_GND
8	72V_CAP
9	-48V_OUT
10	MGMT_PWR
11	5V BLUE LED_PWR *
12	LOGIC_GND
13	-48V_ALARM
14	VRTN_OUT

* PIN 11 IS OPTIONAL

NOTES:

DIMENSIONS ARE IN MILLIMETERS AND (INCHES)
 TOLERANCES: X.Xmm±0.5mm(X.XX in.±0.02 in.)
 X.XXmm±0.25mm(X.XXX in.±0.010 in.)

Pin No	Name	Function
1	-48V_AF	-48V_A Feed (Externally Fused)
2	-48V_BF	-48V_B Feed (Externally Fused)
3	VRTN_AF	VRTN_AF Feed (Externally Fused)
4	VRTN_BF	VRTN_BF Feed (Externally Fused)
5	ENABLE_AF	ENABLE_AF Feed (Externally Fused)
6	ENABLE_BF	ENABLE_BF Feed (Externally Fused)
7	SHELF_GND	Shelf / Chassis / Safety Ground
8	72V_CAP	Holdup/bulk capacitor output voltage (Negative Connection to -48V_OUT)
9	-48V_OUT	OR'd and inrush protected -48V output bus
10	MGMT_PWR	3.3V Isolated Management Power Output (reference to LOGIC_GND)
11	5V BLUE LED_PWR	This pin is optional for 5V Isolated Blue LED Power output (reference to LOGIC_GND)
12	LOGIC_GND	Logic / Secondary / Isolated Ground
13	-48V_ALARM	Opto-isolated -48V A/B Feed Loss or Open Fuse Alarm (reference to LOGIC_GND)
14	VRTN_OUT	OR'd and Inrush Protected VRTN Output Bus

Pin Specification:

Pins 1-14 1.00mm (0.040") diameter

All pins are copper alloy with Tin plating.

PART NUMBERING SYSTEM

DIM	3R3	300	S	F	A
Product Series	Management Power	Output Power	Pin Length		Option Code
DIM - ATCA Input Module	3R3 - with 3.3V	300 - 300W	S - 0.150"	F- RoHS 6/6 (Lead Free)	A - with management power (3.3V) on Pin 10 only, no Pin 11 B - with management power (3.3V) on Pin 10 and Blue LED power (5V) on pin 11

MODEL LIST

MODEL NAME	INPUT		OUTPUT 1	OUTPUT 2 (Pin10) Management Power	OUTPUT 3 (Pin11) Blue LED Power	Eff @ 100% Input Power
DIM3R3300SFA	36V~75V	300W	36V~75V	3.3V/2.4A	NA	98%
DIM3R3300SFB	36V~75V	300W	36V~75V	3.3V/2.4A	5V/0.1A	98%

CONTACT: www.deltaww.com/dcdc

<p>USA: Telephone: East Coast: 978-656-3993 West Coast: 510-668-5100 Fax: (978) 656 3964 Email: DCDC@delta-corp.com</p>	<p>Europe: Phone: +31-20-655-0967 Fax: +31-20-655-0999 Email: DCDC@delta-es.com</p>	<p>Asia & the rest of world: Telephone: +886 3 4526107 ext 6220-6224 Fax: +886 3 4513485 Email: DCDC@delta.com.tw</p>
---	---	---

WARRANTY

Delta offers a two (2) year limited warranty. Complete warranty information is listed on our web site or is available upon request from Delta.

Information furnished by Delta is believed to be accurate and reliable. However, no responsibility is assumed by Delta for its use, nor for any infringements of patents or other rights of third parties, which may result from its use. No license is granted by implication or otherwise under any patent or patent rights of Delta. Delta reserves the right to revise these specifications at any time, without notice.