



PART No. 1420P9

for more information visit
www.hammfg.com

Data subject to change without notice

Isometric drawing Not to Scale

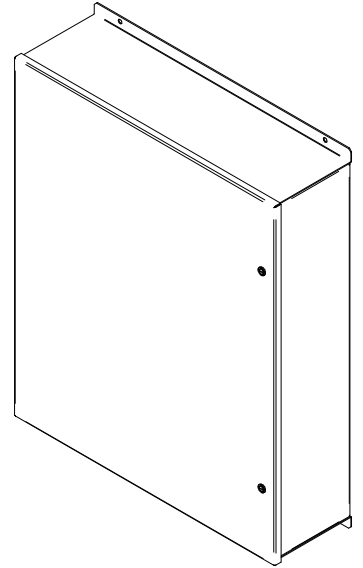

ISOMETRIC VIEW



TOP VIEW

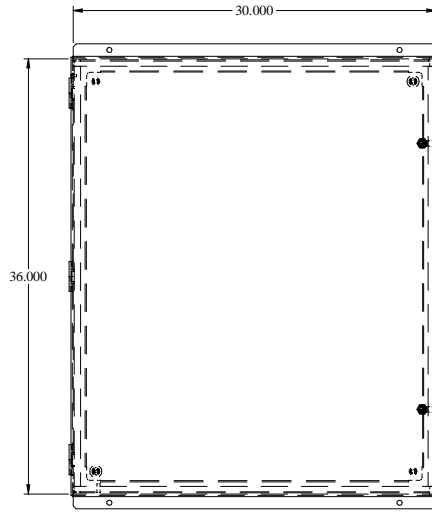

FRONT VIEW

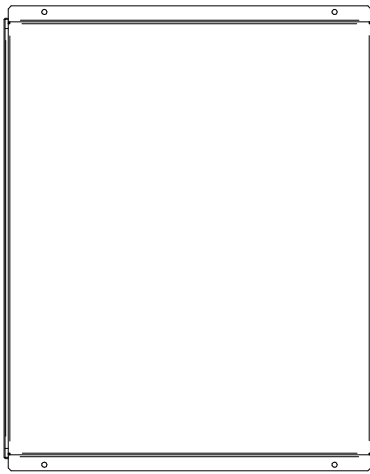

BACK VIEW

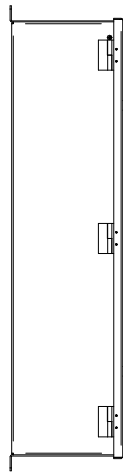

SIDE VIEW

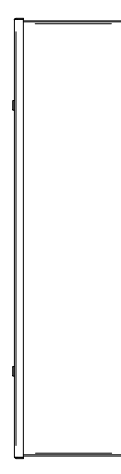

SIDE VIEW

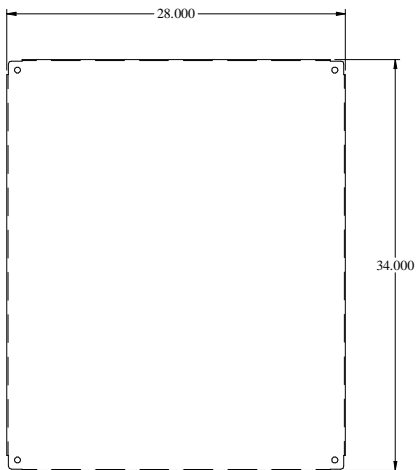

INNER PANEL

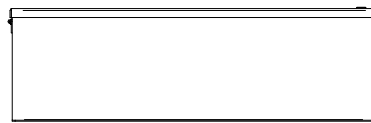

BOTTOM VIEW