

SPECIFICATION

Part No. : **MA750.A.ABICG.003**

Product Name : Pantheon Antenna 5in1 MA.750
 Screw-Mount (Permanent Mount)
 4G/3G/2G MIMO, GPS/GLONASS/GALILEO,
 2.4/5GHz MIMO

Feature : 2 x cellular (4G/3G/2G) Antennas (MIMO)
 (698~960MHz, 1710~2170MHz,2300~2700MHz,
 2900-3500MHz)

- 1*MIMO main antenna
- 1*MIMO diversity antenna

1 x GPS/GLONASS/GALILEO 1575.42/1602MHz
 Active Antenna

2 x 2.4GHZ/ 5GHz Antennas (MIMO)

- 1*MIMO main antenna
- 1*MIMO diversity antenna

IP67 Waterproof
 Front End SAW Filter
 High Efficiency / Peak Gain Outdoor Antenna
 RoHS Compliant



1. Introduction

The MA.750 Pantheon antenna is an omni-directional heavy-duty, fully IP67 waterproof external M2M antenna for use in telematics, transportation and remote monitoring applications.

This unique antenna delivers powerful MIMO antenna technology for cellular/LTE and Wi-Fi 802.11n and emerging 802.11ac, plus GPS/GLONASS/GALILEO for next generation multiple wireless technology systems, such as telematics. The GPS/GLONASS/GALILEO antenna has a Front End SAW Filter.

Examples are new fleet management and real time video applications that demand high speed video uplink and downlink. High efficiency and high gain MIMO antennas are necessary to achieve the required signal to noise ratio and throughput required to solve these challenges.

Five (5) high performance antennas are integrated into an extremely robust IP67 direct/permanent mount antenna package with excellent isolation (20dB+).

The antenna has its own ground-plane and can radiate on any mounting environment like metal or plastic without affecting performance. The cables are low loss allowing for lengths of up to 10 meters (32' and 9.70"), critical for buses, trains and other commercial transport applications.

Customized cables and connector version available.

2. Specification Table

4G/3G/2G MIMO					
Frequency	698~960	1710~2170	2300~2700	2900-3500	MHz
VSWR	3 Max				
Polarization	Vertical				
Impedance	50				Ω

2.4GHz / 5GHz MIMO			
Frequency	2.4~2.5	4.5~5.85	GHz
VSWR	2 Max		
Polarization	Linear		
Impedance	50		Ohm

GPS-GLONASS-GALILEO						
Centre Frequency	1575.42MHz / 1602MHz					
Bandwidth	10MHz					
Radiation Efficiency	50(without cable)					
Passive Gain @ Zenith	4.0 typ(with $\psi=140$ mm ground)					
VSWR	2					
Impedance	50 Ω					
DC Power Input Range	3 ~ 5V					
DC input	3.3V		4.0V		5.5V	
MHz	1575.42	1602	1575.42	1602	1575.42	1602
VSWR	2	2	2	2	2	2
LNA Gain	29.2	29	31	31	32.3	32
Noise Figure	3.1	3.1	3.2	3.2	3.4	3.4
Power Consumption	7.5	7.5	9.4	9.4	15	15
Band Attenuation	1520MHz: -20dB 1642MHz: -20dB		1520MHz: -20dB 1642MHz: -20dB		1520MHz: -20dB 1642MHz: -20dB	
Cable	3m RG-174 standard, fully customizable					
Connector	SMA(M) standard, fully customizable					

MECHANICAL	
Antenna Dimensions	Height 85.7mm x Diameter 145.6mm
Casing	Wonderloy PC-540 PC/ABS Alloy
Waterproof	IP67
2G/3G/4G MIMO 1	3M CFD-200 SMA(M)
2G/3G/4G MIMO 2	3M CFD-200 SMA(M)
2.4/5GHz MIMO 1	3M CFD-200 RP-SMA(M)
2.4/5GHz MIMO 2	3M CFD-200 RP-SMA(M)
GPS/GLONASS/GALILEO	3M RG-174 SMA(M)
Base and thread	CAN10 Zinc Alloy
Thread diameter	M30 x 2 (30mm)
Nut	Nickel Plated Steel
Foam	3M 9448HK
Waterproof	IP67
Weight(kg)	1.29(antenna) 1.53(with box)
Recommended Torque for Mounting	49 N·m
Max Torque for Mounting	58.8N·m
ENVIRONMENTAL	
Operation Temperature	-40°C to 85°C
Storage Temperature	-40°C to 90°C
Humidity	Non-condensing 65°C 95% RH

* all measurements were conducted with 3m low loss CFD200 cable

LTE BANDS				
Band Number	LTE / LTE-Advanced / WCDMA / HSPA / HSPA+ / TD-SCDMA			
	Uplink	Downlink	MIMO 1	MIMO 2
1	UL: 1920 to 1980	DL: 2110 to 2170	✓	✓
2	UL: 1850 to 1910	DL: 1930 to 1990	✓	✓
3	UL: 1710 to 1785	DL: 1805 to 1880	✓	✓
4	UL: 1710 to 1755	DL: 2110 to 2155	✓	✓
5	UL: 824 to 849	DL: 869 to 894	✓	✗
7	UL: 2500 to 2570	DL: 2620 to 2690	✓	✓
8	UL: 880 to 915	DL: 925 to 960	✓	✗
9	UL: 1749.9 to 1784.9	DL: 1844.9 to 1879.9	✓	✓
11	UL: 1427.9 to 1447.9	DL: 1475.9 to 1495.9	✗	✗
12	UL: 699 to 716	DL: 729 to 746	✓	✓
13	UL: 777 to 787	DL: 746 to 756	✓	✓
14	UL: 788 to 798	DL: 758 to 768	✓	✓
17	UL: 704 to 716	DL: 734 to 746 (LTE only)	✓	✓
18	UL: 815 to 830	DL: 860 to 875 (LET only)	✓	✗
19	UL: 830 to 845	DL: 875 to 890	✓	✗
20	UL: 832 to 862	DL: 791 to 821	✓	✗
21	UL: 1447.9 to 1462.9	DL: 1495.9 to 1510.9	✗	✗
22	UL: 3410 to 3490	DL: 3510 to 3590	✓	✗
23	UL: 2000 to 2020	DL: 2180 to 2200 (LTE only)	✓	✓
24	UL: 1625.5 to 1660.5	DL: 1525 to 1559 (LTE only)	✓	✓
25	UL: 1850 to 1915	DL: 1930 to 1995	✓	✓
26	UL: 814 to 849	DL: 859 to 894	✓	✗
27	UL: 807 to 824	DL: 852 to 869 (LTE only)	✓	✗
28	UL: 703 to 748	DL: 758 to 803 (LTE only)	✓	✗
29	UL: -	DL: 717 to 728 (LTE only)	✓	✓
30	UL: 2305 to 2315	DL: 2350 to 2360 (LTE only)	✓	✓
31	UL: 452.5 to 457.5	DL: 462.5 to 467.5 (LTE only)	✗	✗
32	UL: -	DL: 1452 - 1496	✗	✗
35		1850 to 1910	✓	✓
38		2570 to 2620	✓	✓
39		1880 to 1920	✓	✓
40		2300 to 2400	✓	✓
41		2496 to 2690	✓	✓
42		3400 to 3600	✓	✗
43		3600 to 3800	✗	✗

*Covered bands represent an efficiency greater than 20%

3. LTE MIMO

3.1. LTE MIMO 1 and LTE MIMO 2 Specification

3.1.1. Return Loss

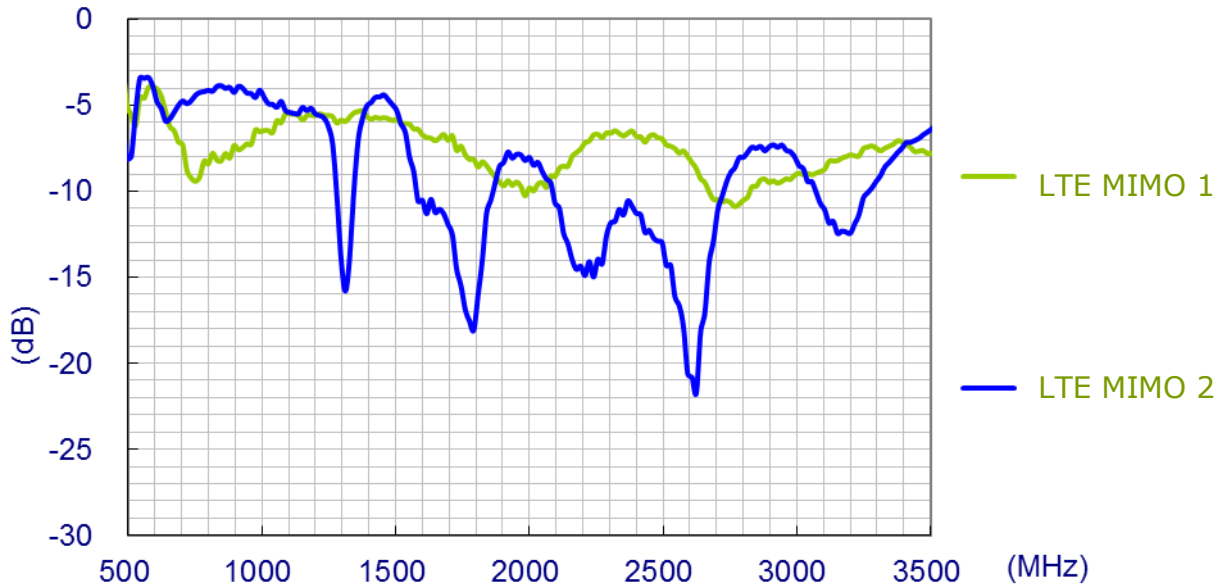

3.1.2. Maximum Gain

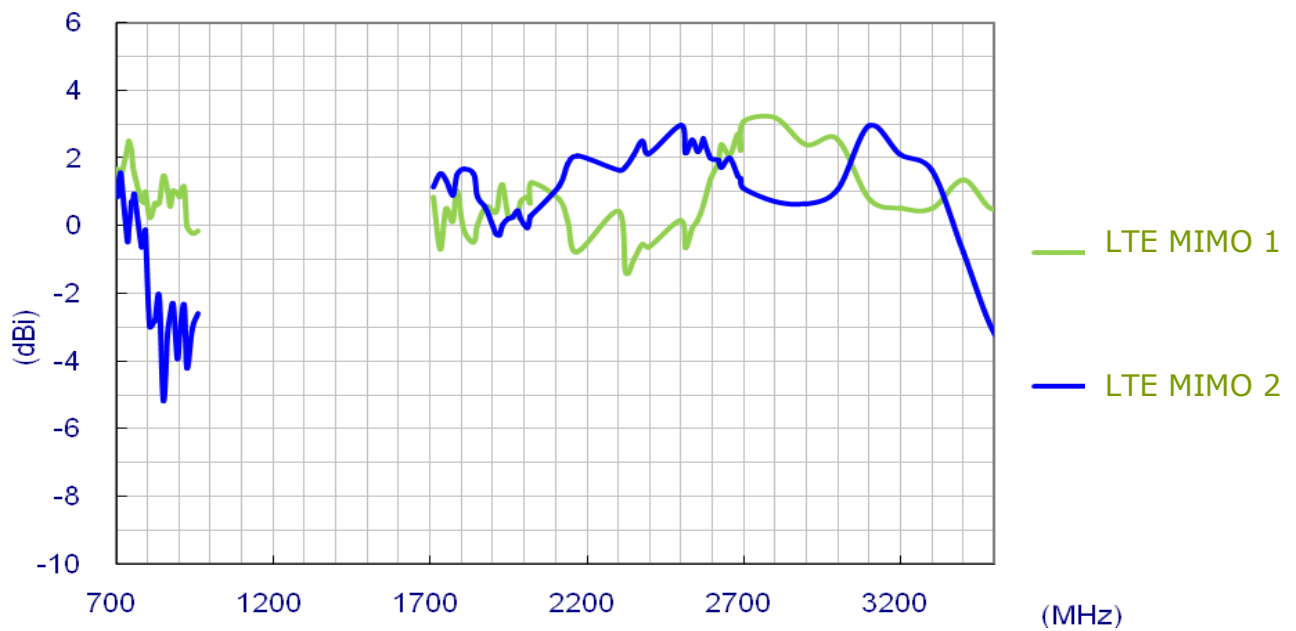

3.1.3. Average Gain

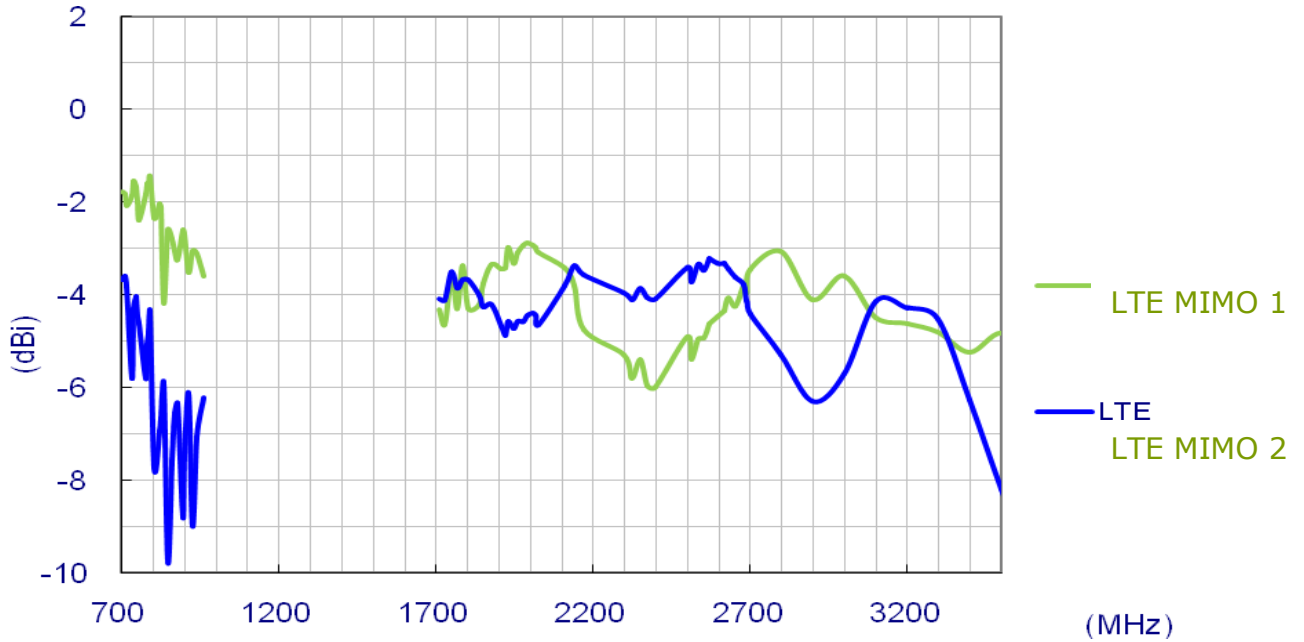

3.1.4. Efficiency

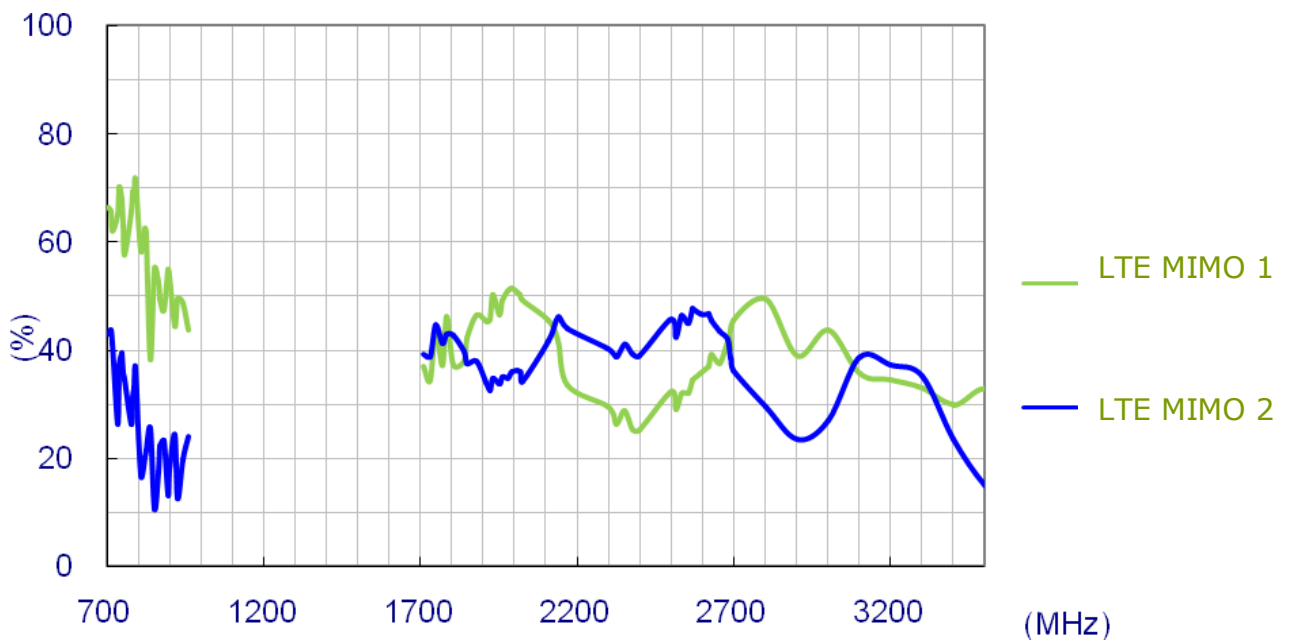

3.2. Radiation Patterns



3.2.1. LTE MIMO 1 Radiation Pattern

XY Plane

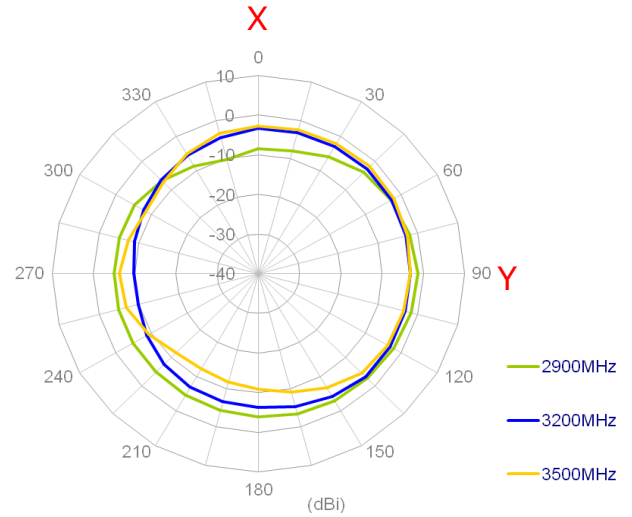
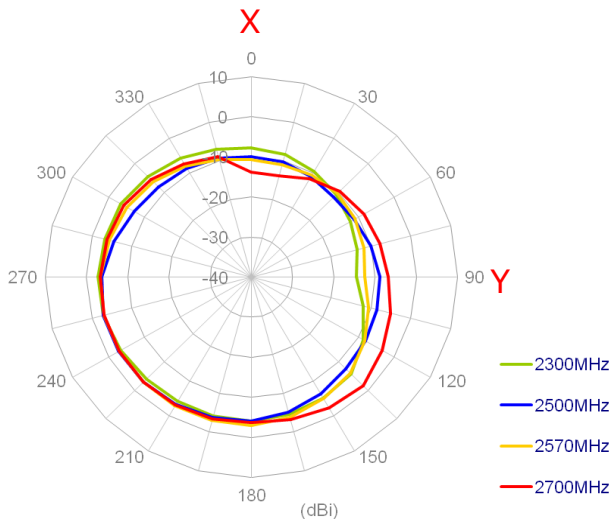
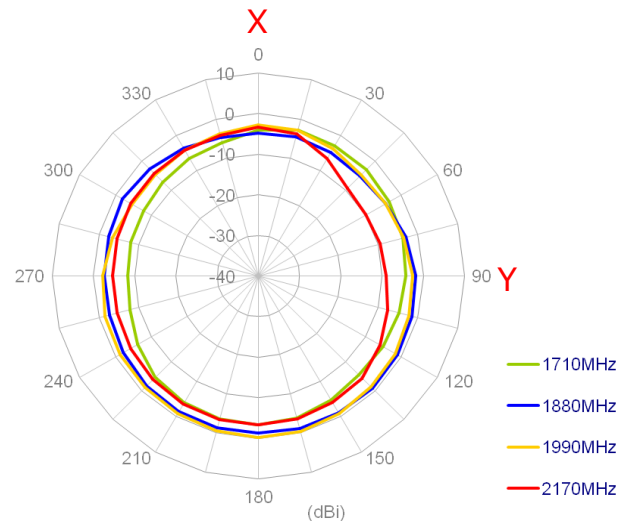
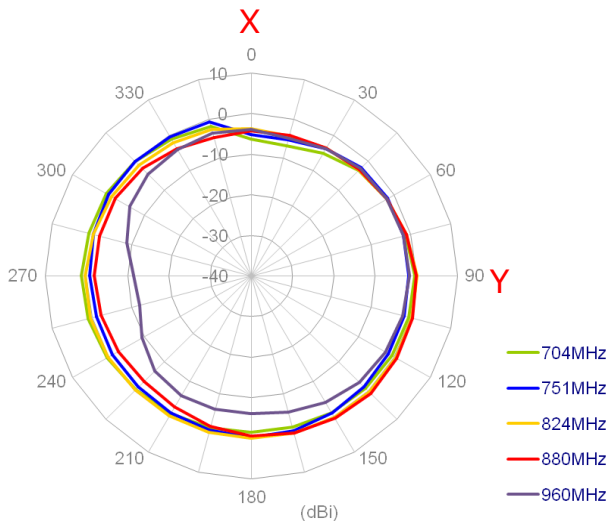

XZ Plane

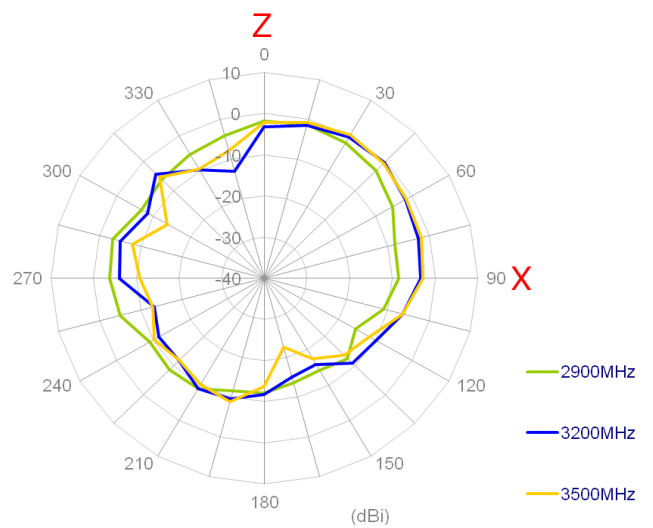
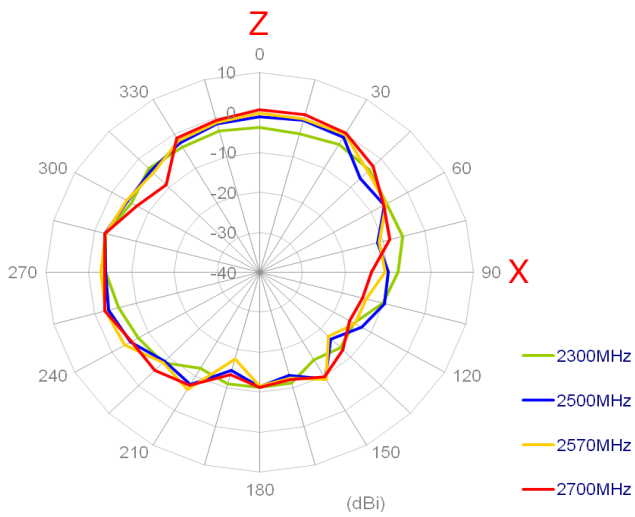
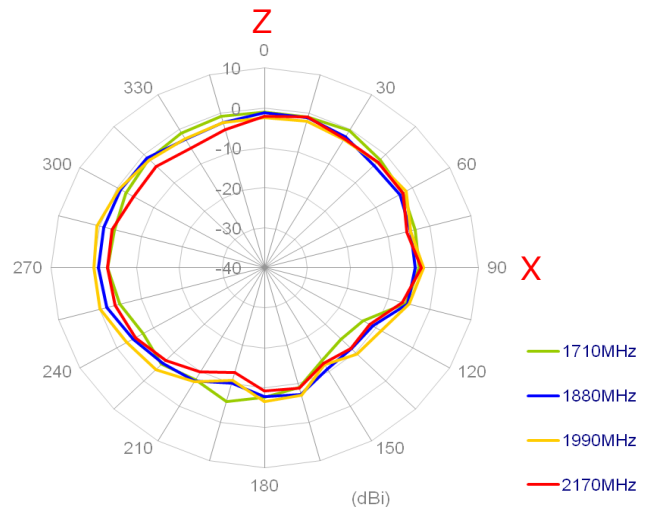
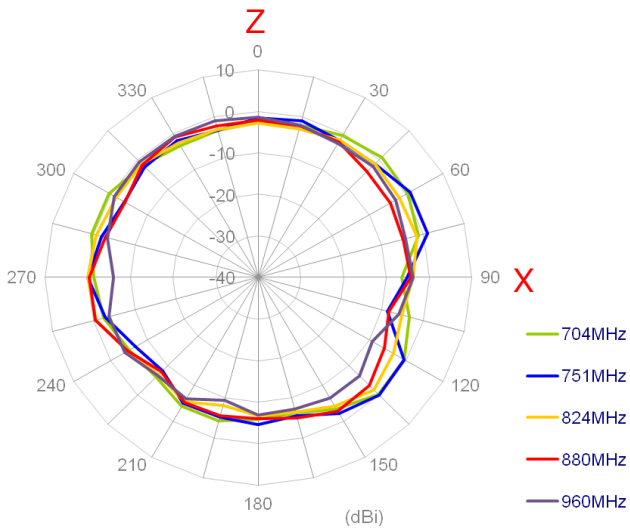

3.2.2. LTE MIMO 2 Radiation Pattern

XY Plane

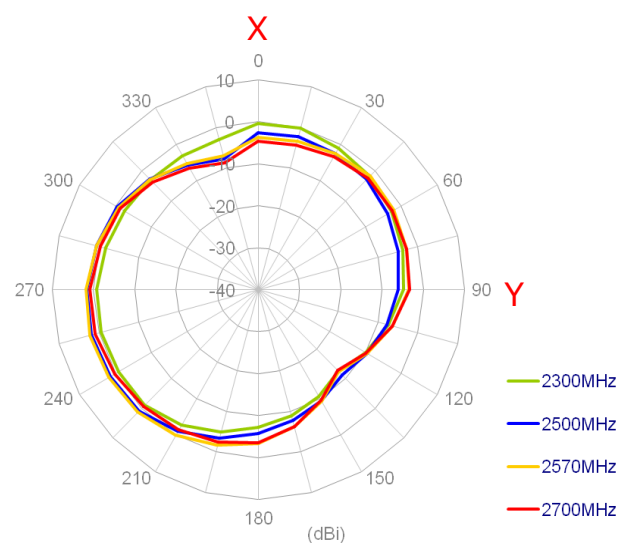
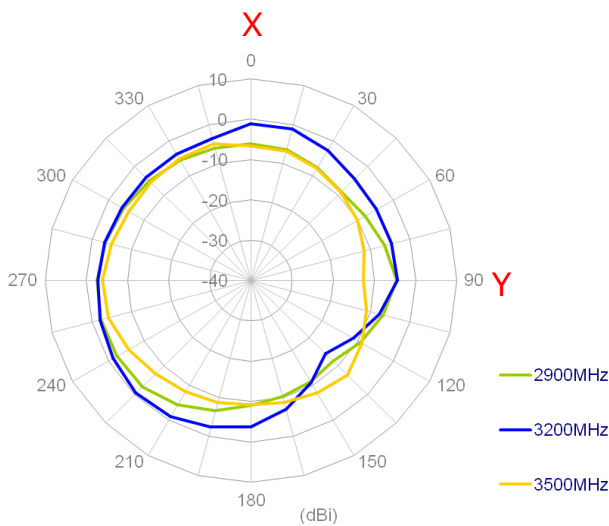
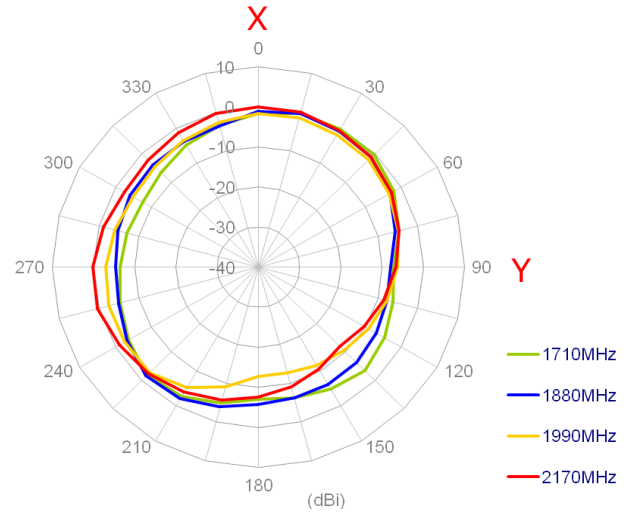
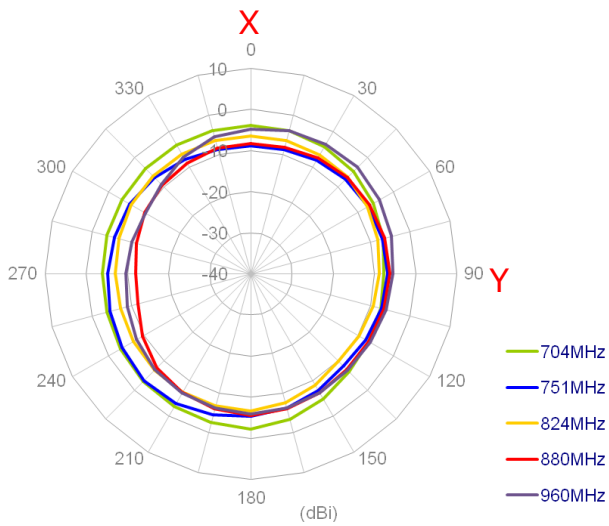

XZ Plane

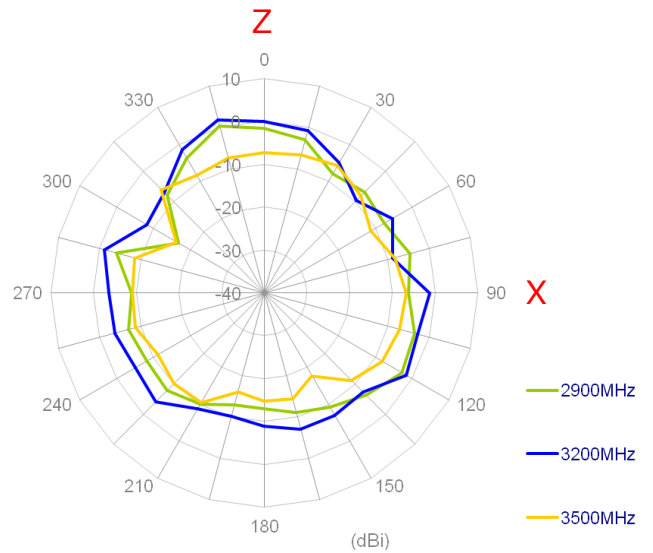
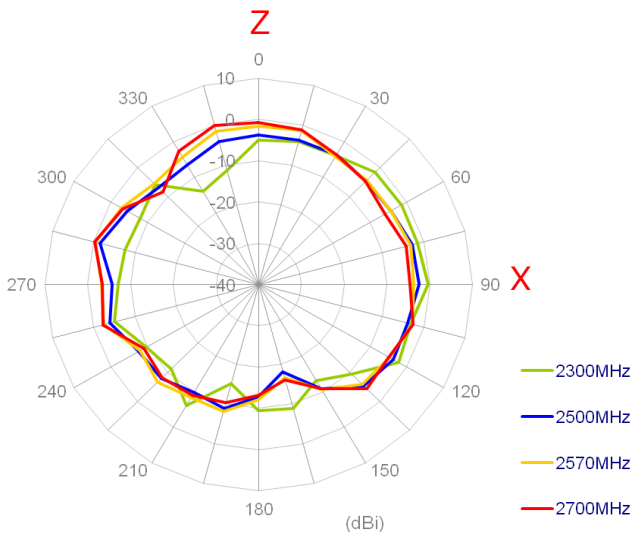
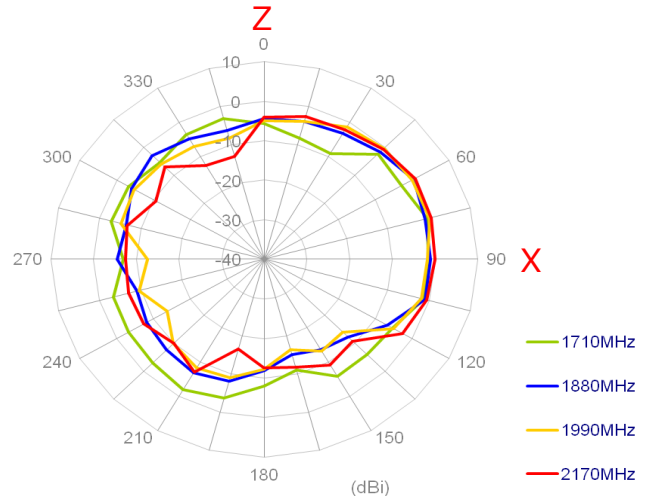
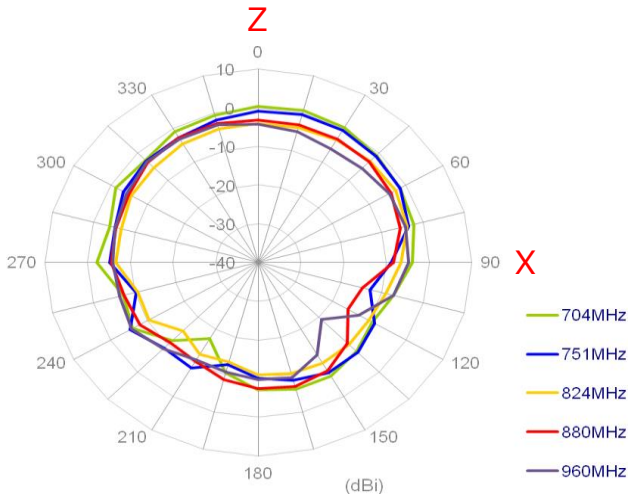

4. 2.4/5GHz MIMO

4.1. 2.4/5 GHz MIMO 1 and MIMO 2 Specification

4.1.1. Return Loss

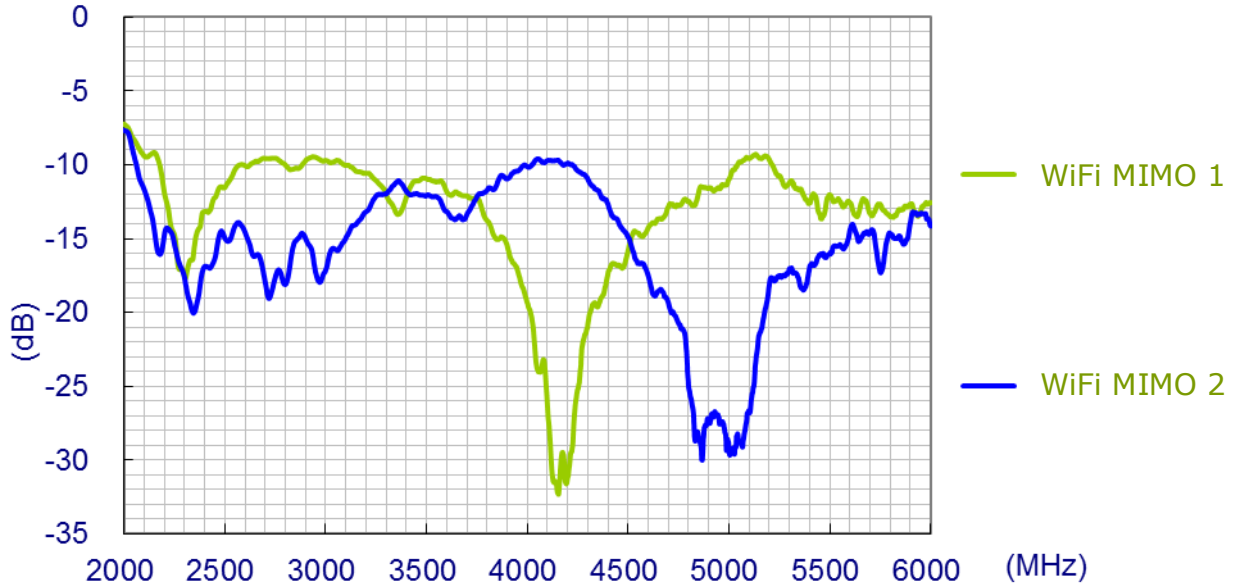

4.1.2. Maximum Gain

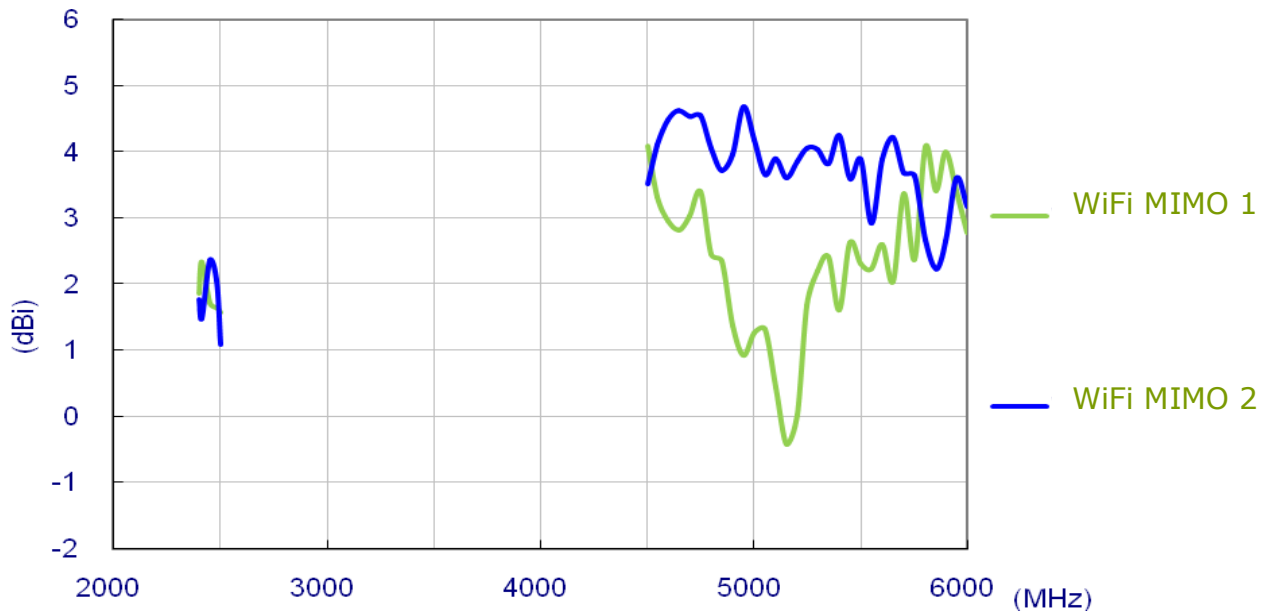

4.1.3. Average Gain

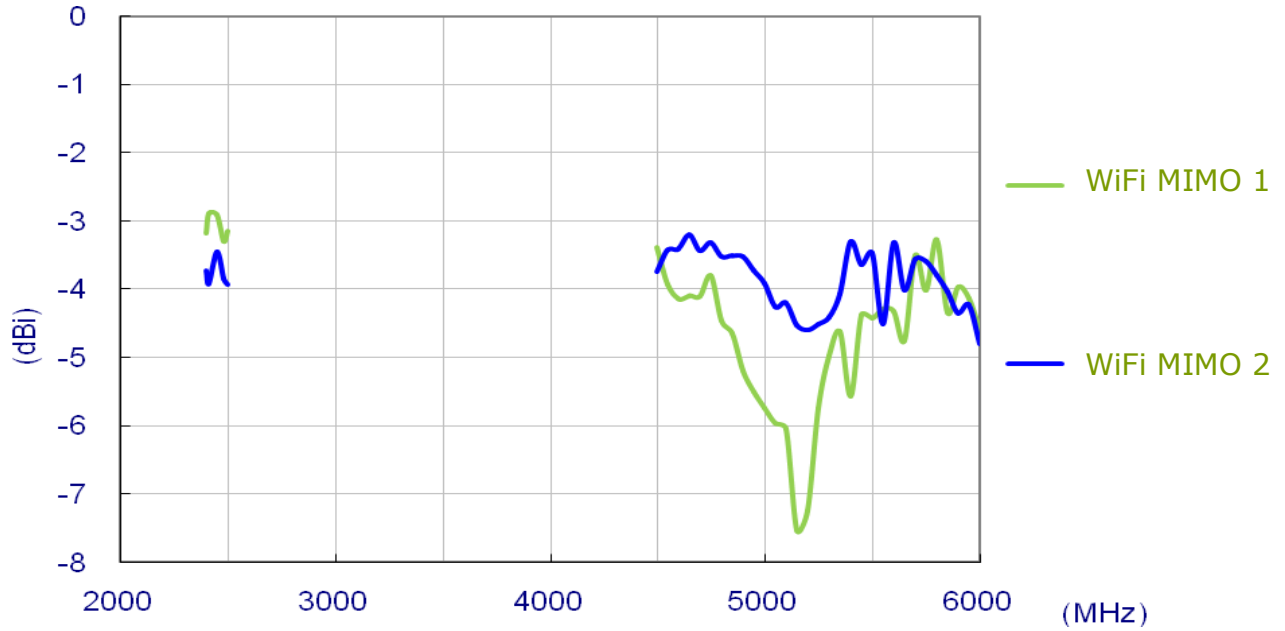

4.1.4. Efficiency

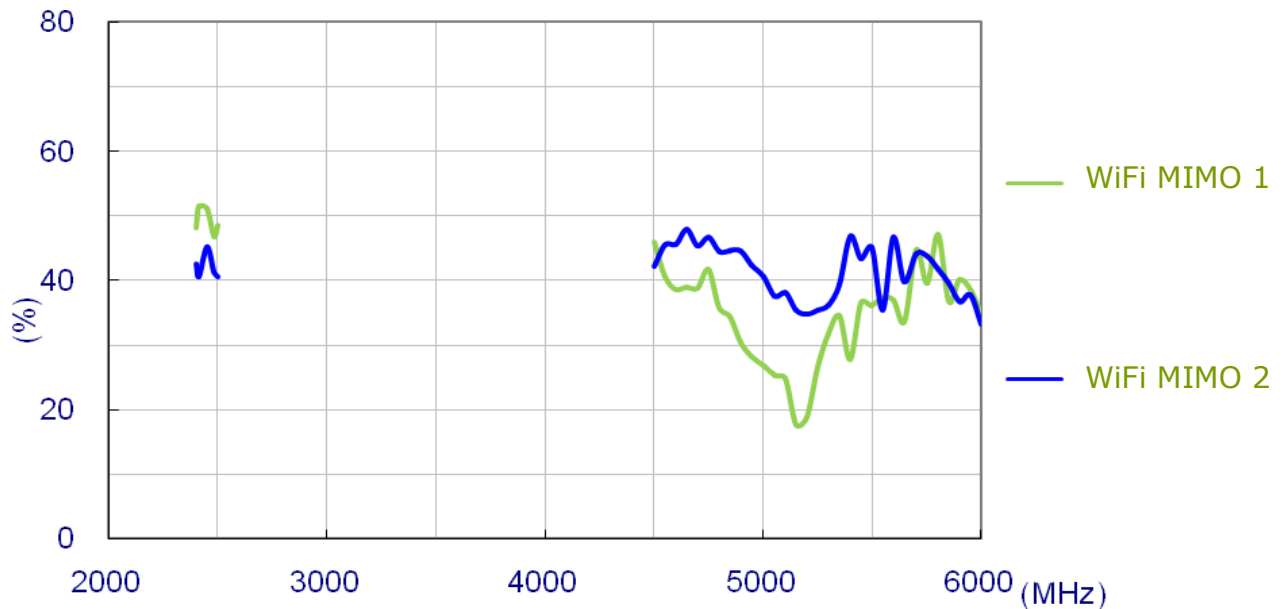

4.2. Radiation Patterns



4.2.1. 5GHz MIMO 1

XY Plane

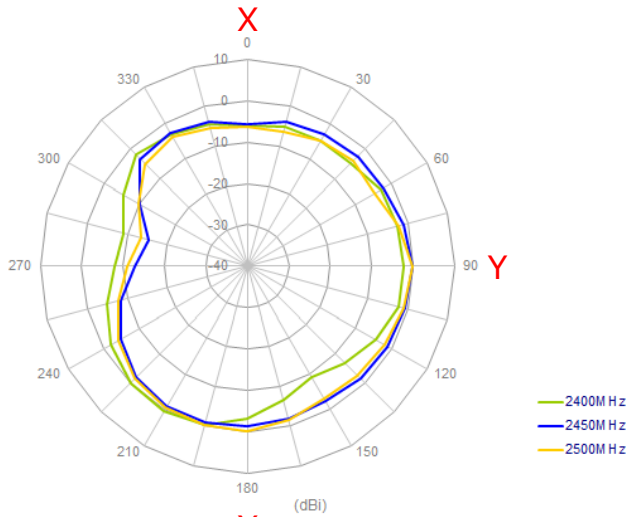

XZ Plane

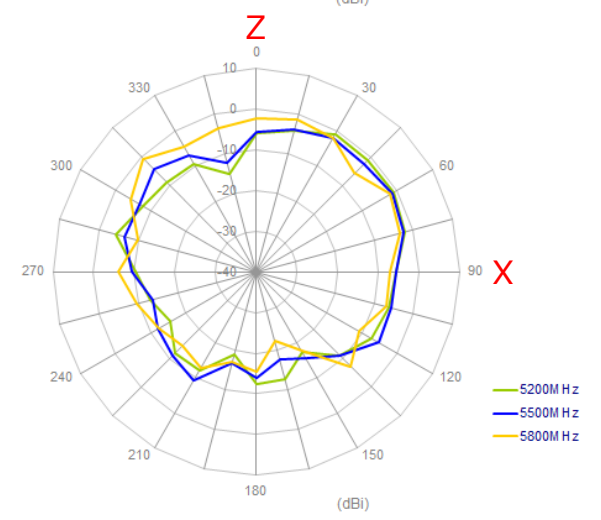
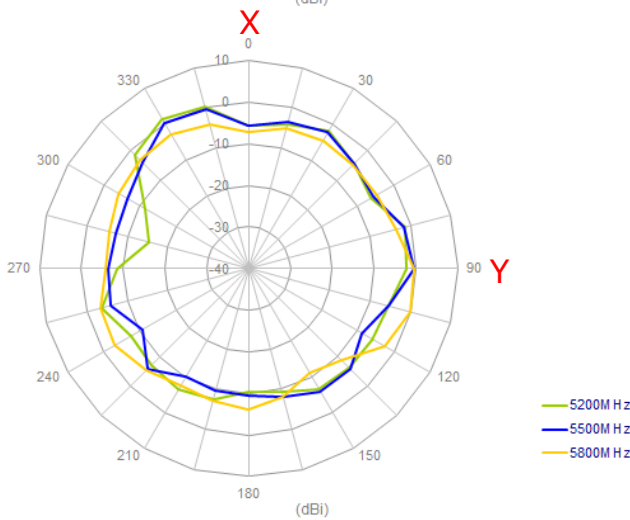
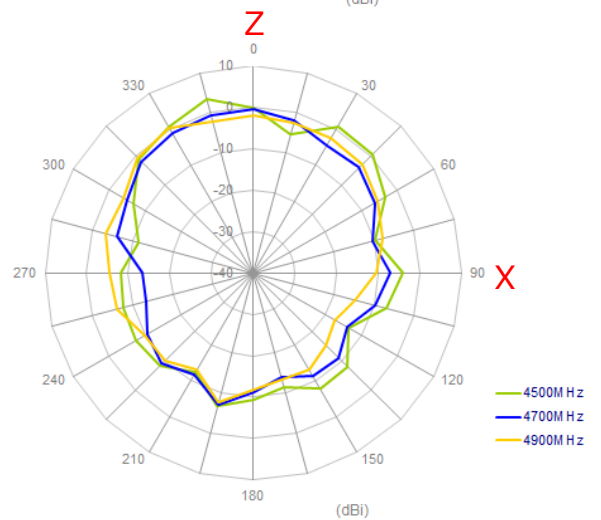
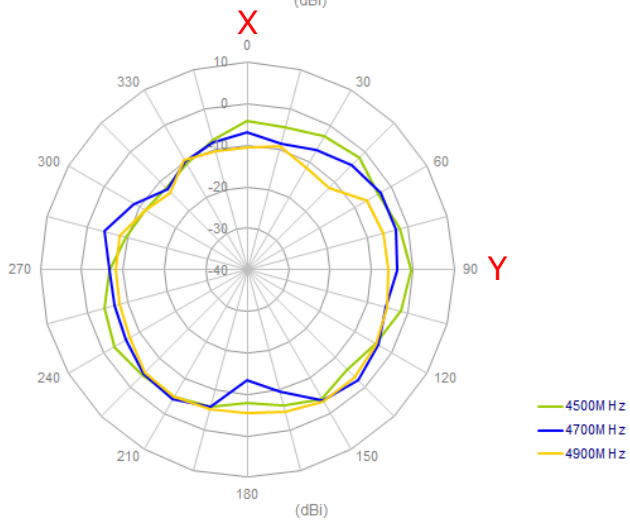
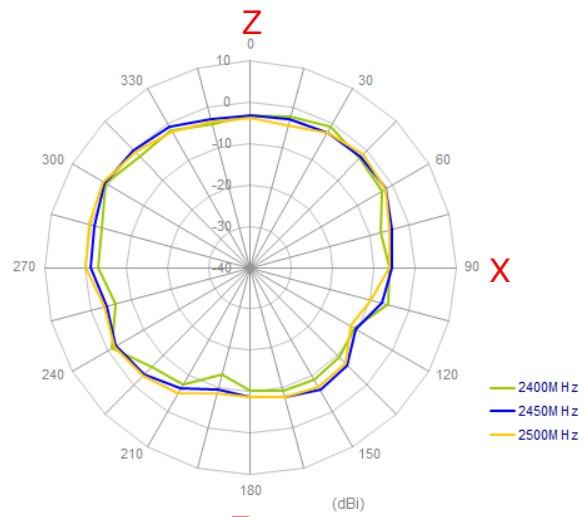

4.2.2. 2.4/5GHz MIMO 2

XY Plane

XZ Plane

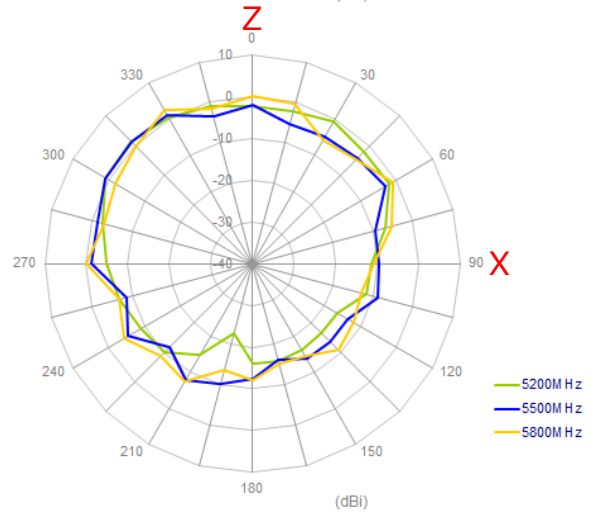
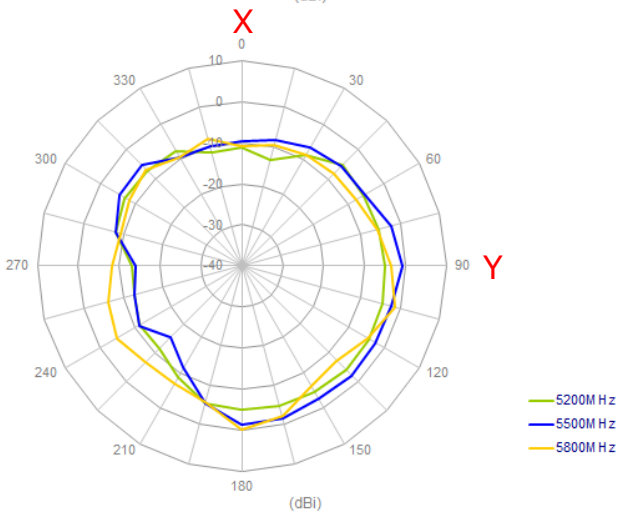
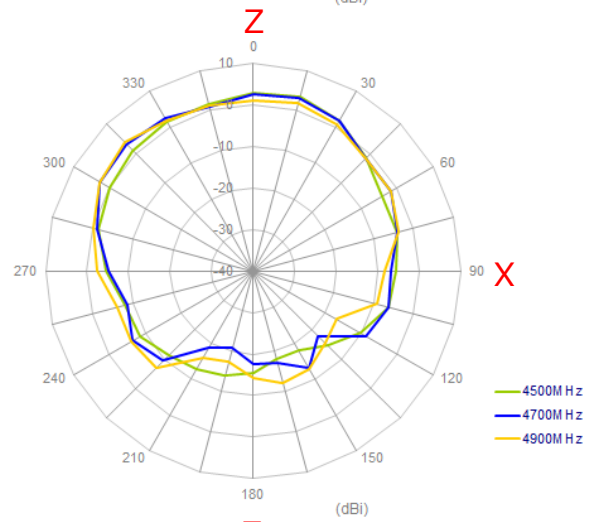
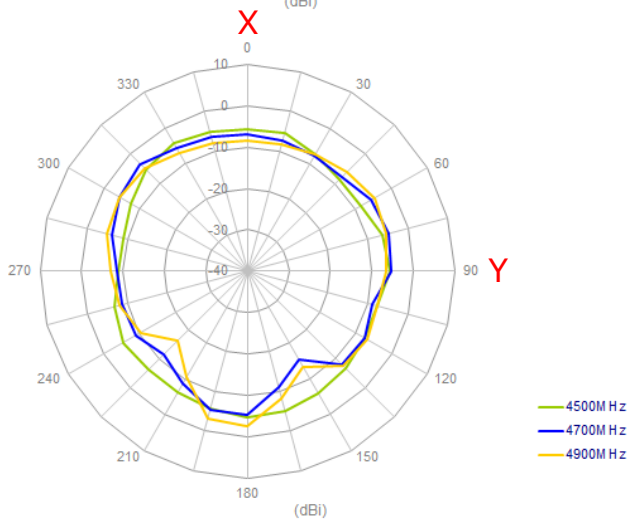
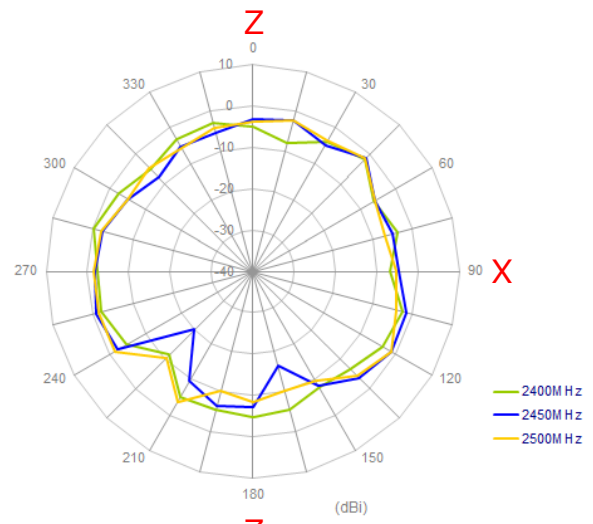
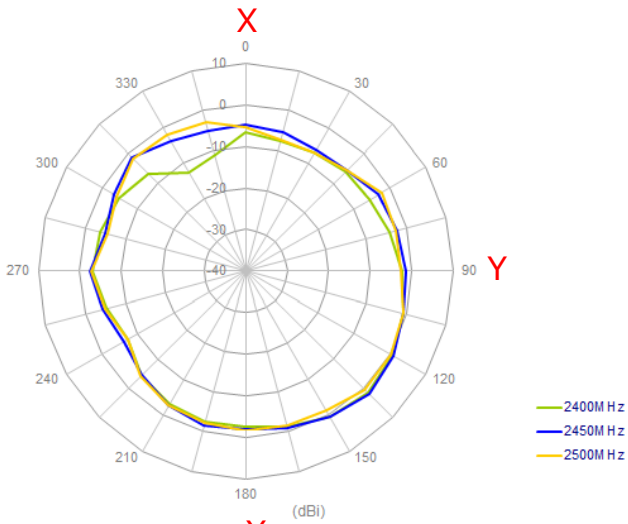

5. GPS/GLONASS/GALILEO Antenna Characteristics

5.1. Block diagram

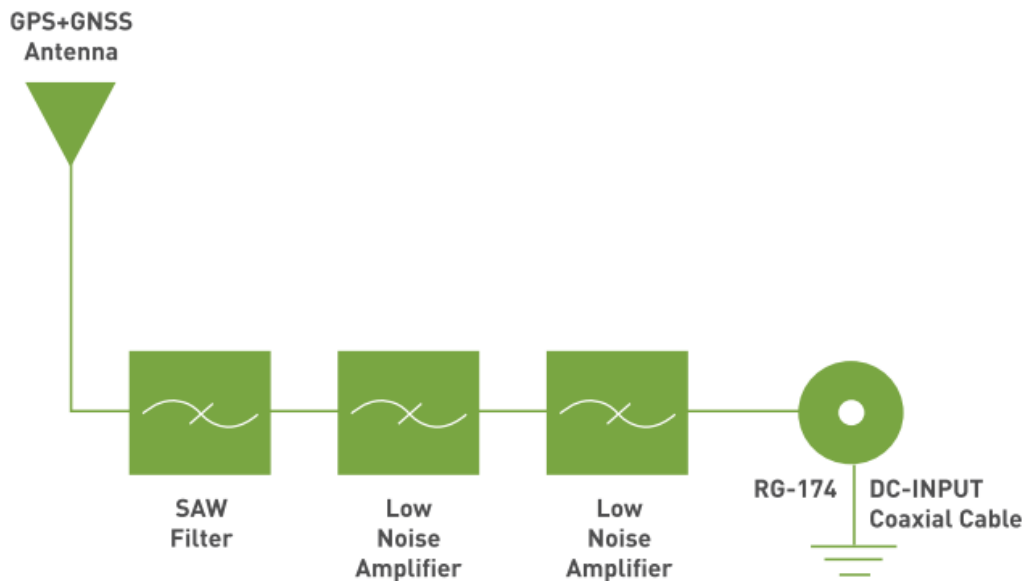

5.2. Return Loss

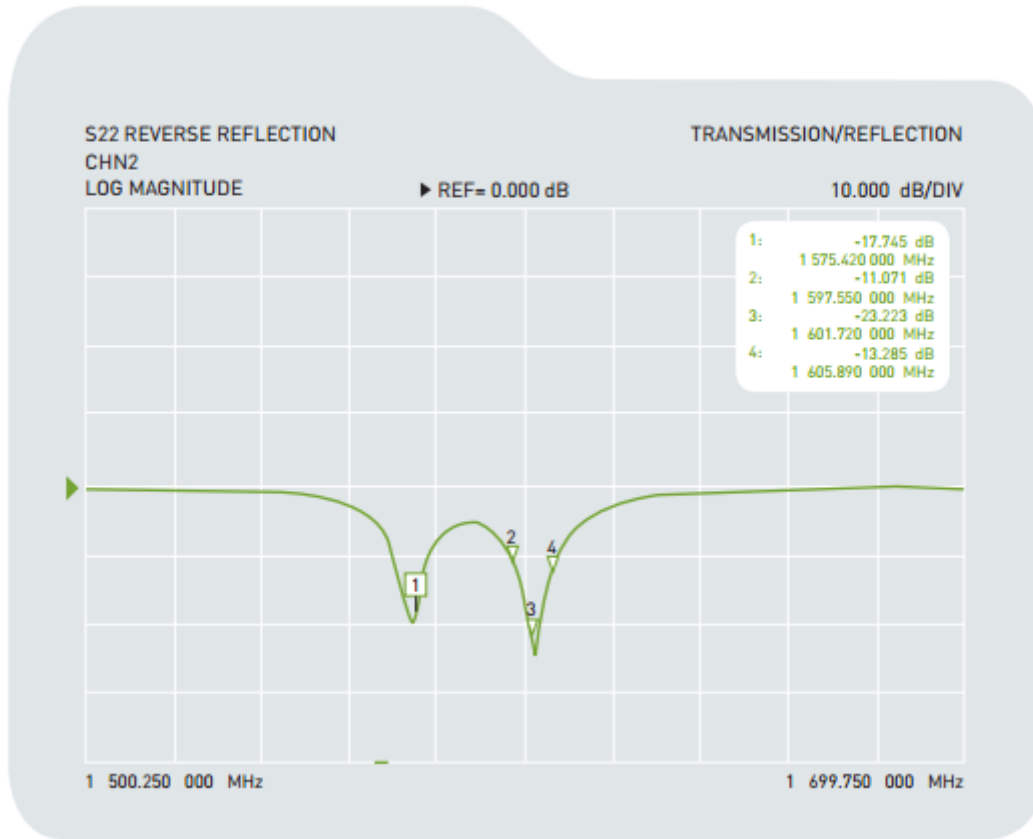

5.3. GPS/GLONASS/GALILEO Antenna Radiation Pattern



XYZ co-ordinate for reference.

XZ Plane Free Space @1575.42MHz

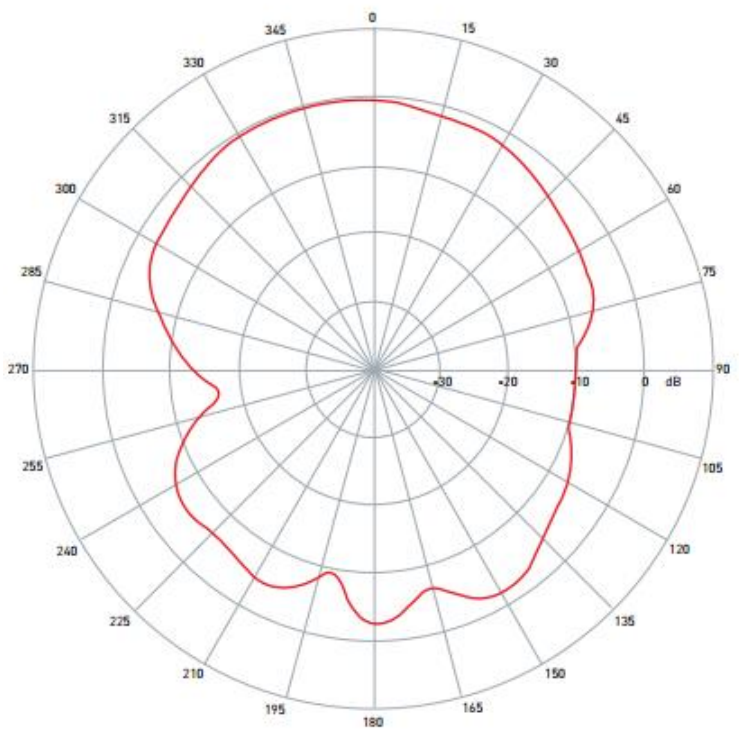

YZ Plane Free Space @1575.42MHz

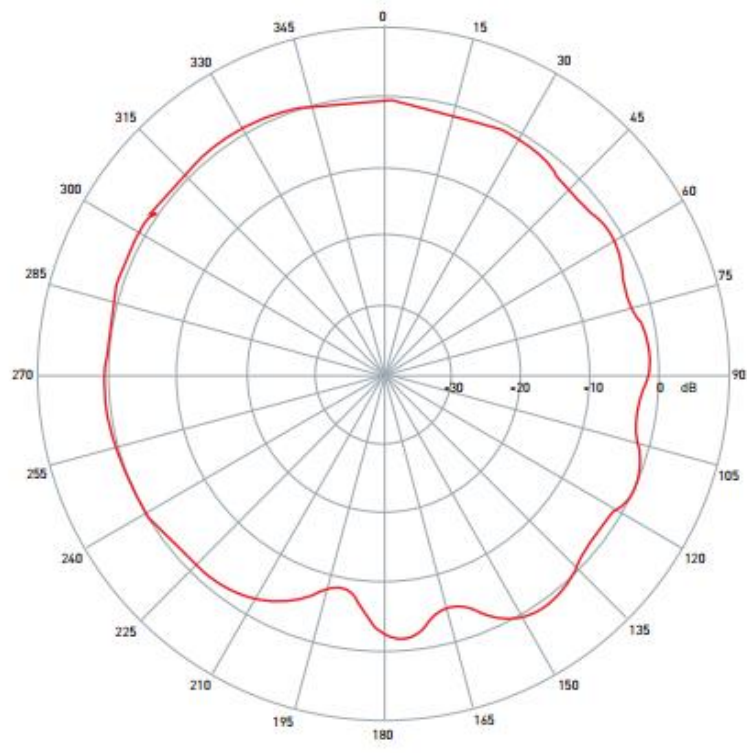

XZ Plane Free Space @1602MHz

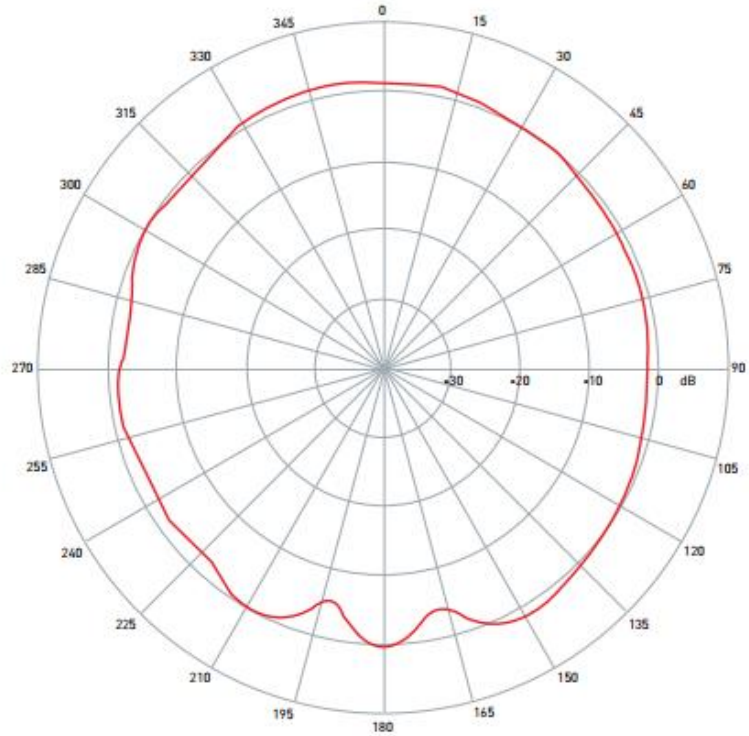

YZ Plane Free Space @1602MHz

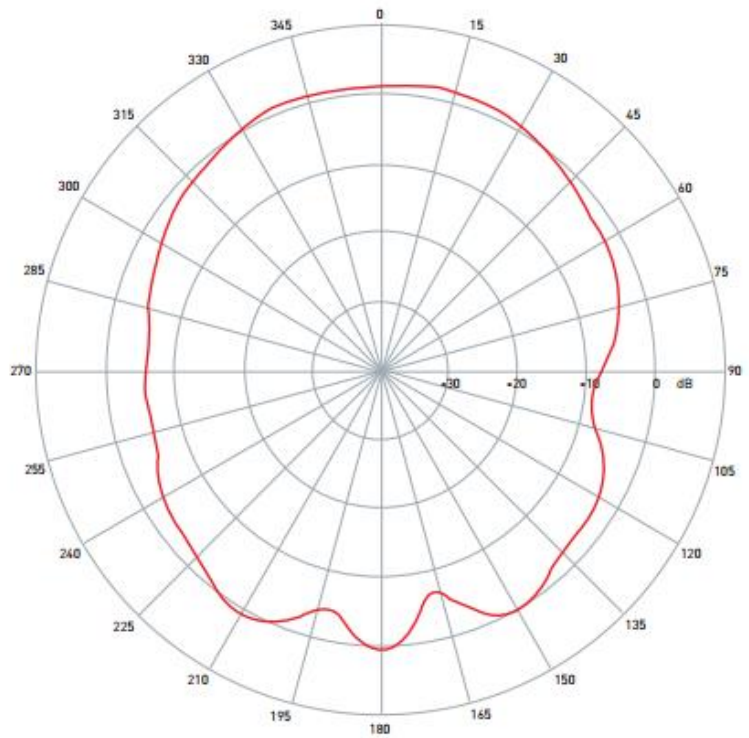

5.4. GPS/GLONASS/GALILEO LNA

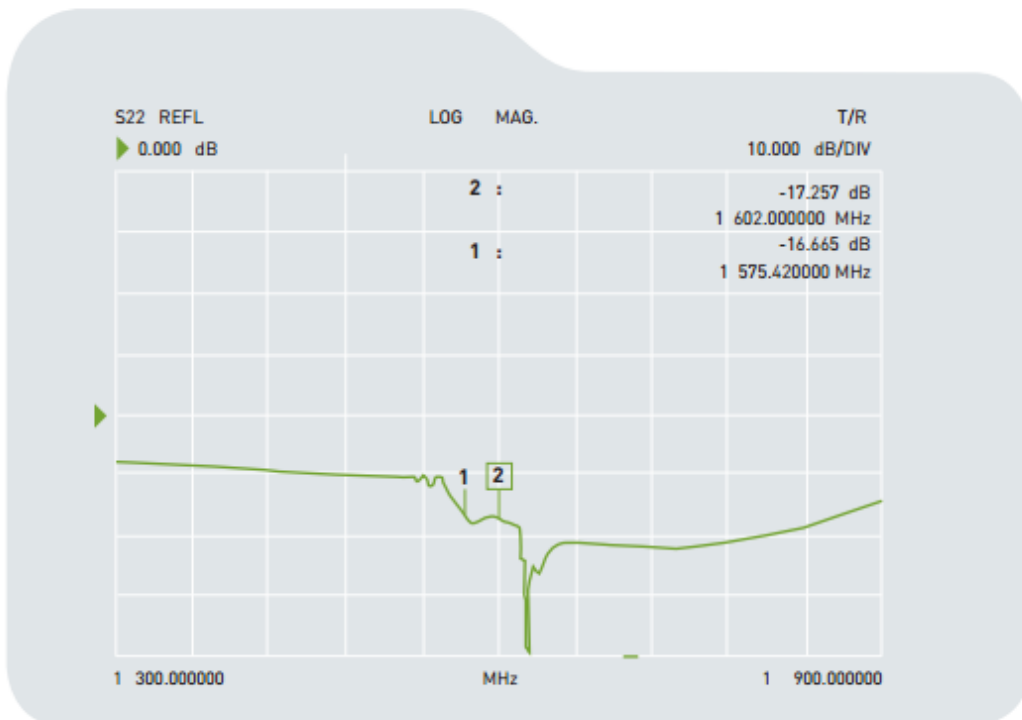
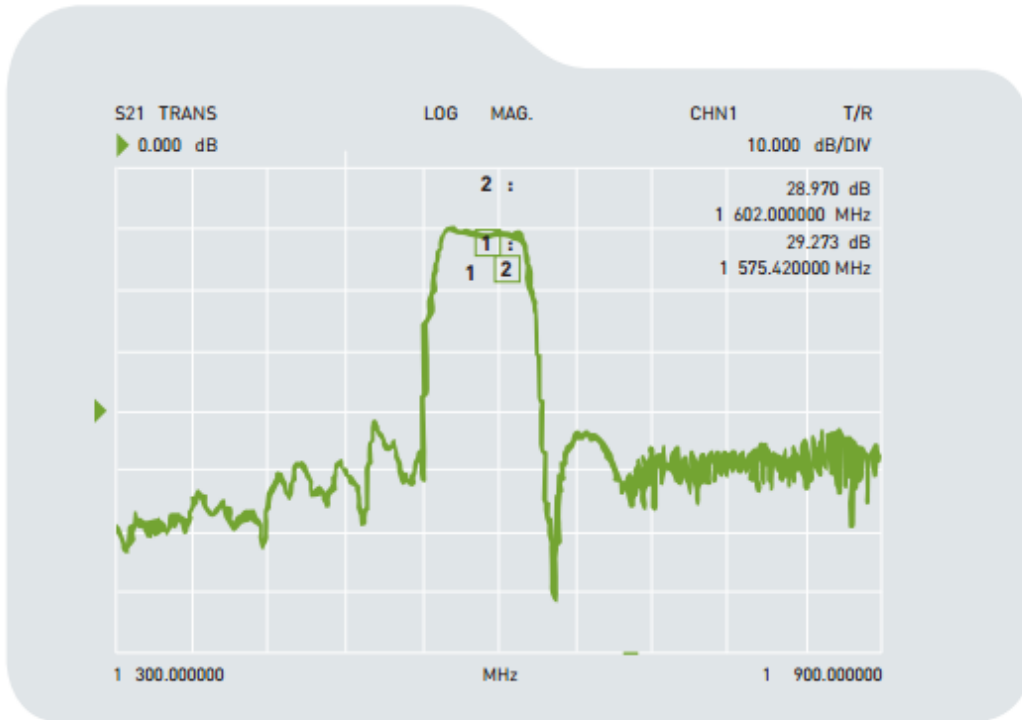

6. Drawing (Unit: mm)

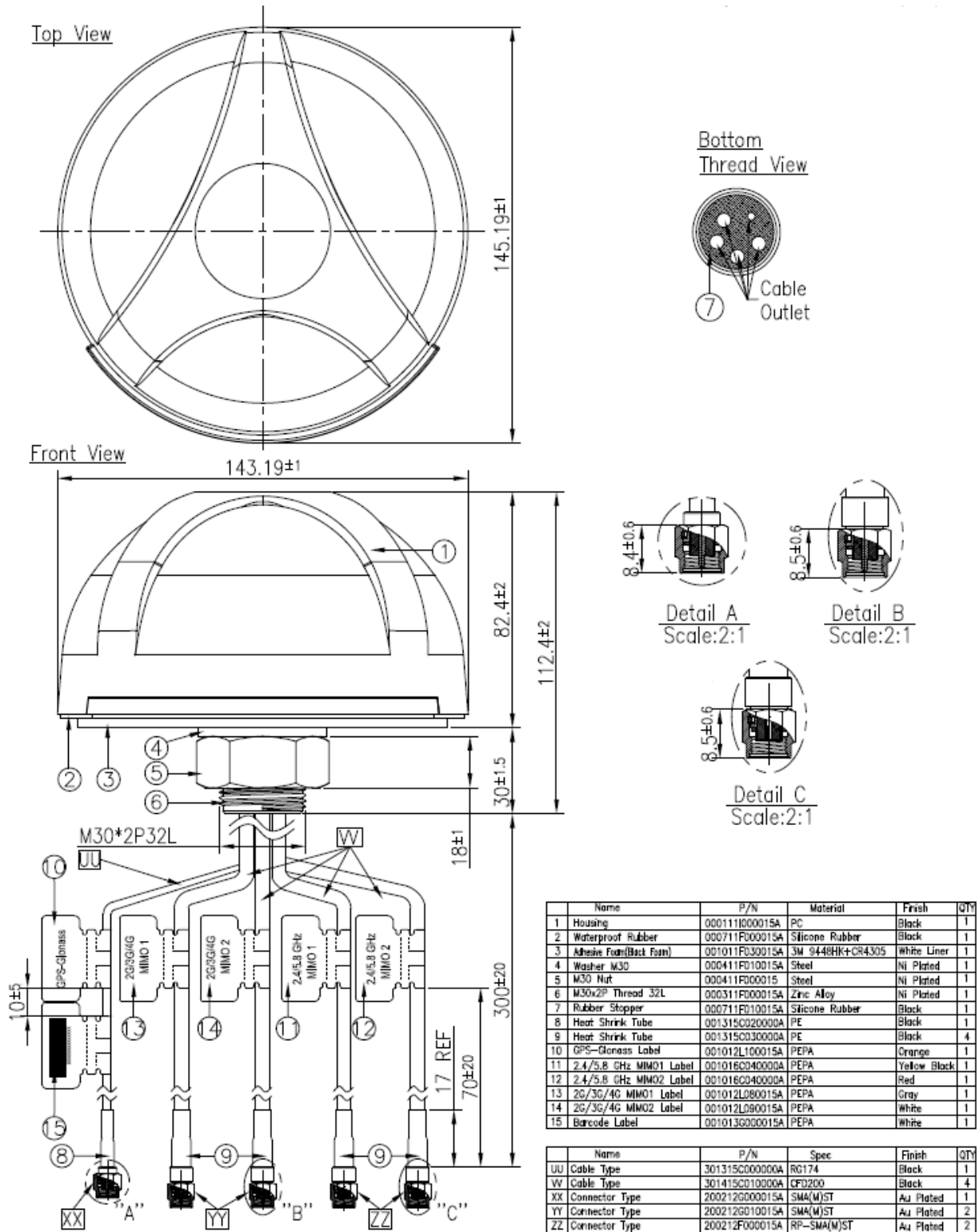

7. Installation

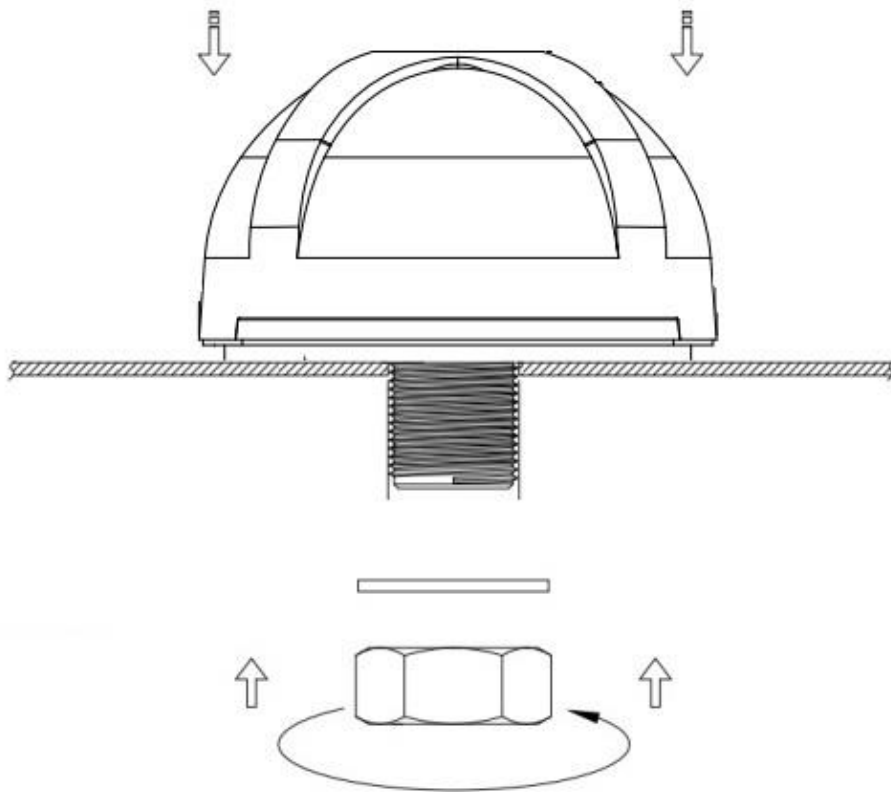

Recommended Torque for Mounting 49 N·m
 Maximum Torque for Mounting 58.8 N·m

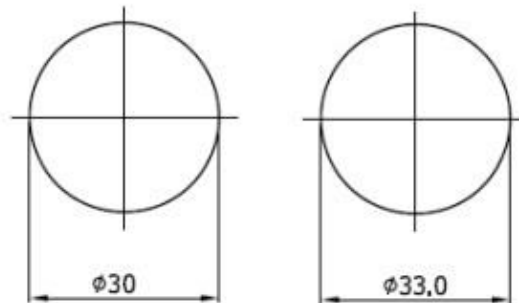

**Thread
 Diameter**

**Recommended
 Mounting Hole**

Unit: mm

8. Packaging

- 1 Antenna Individual Box
- Weight: 1.53Kg

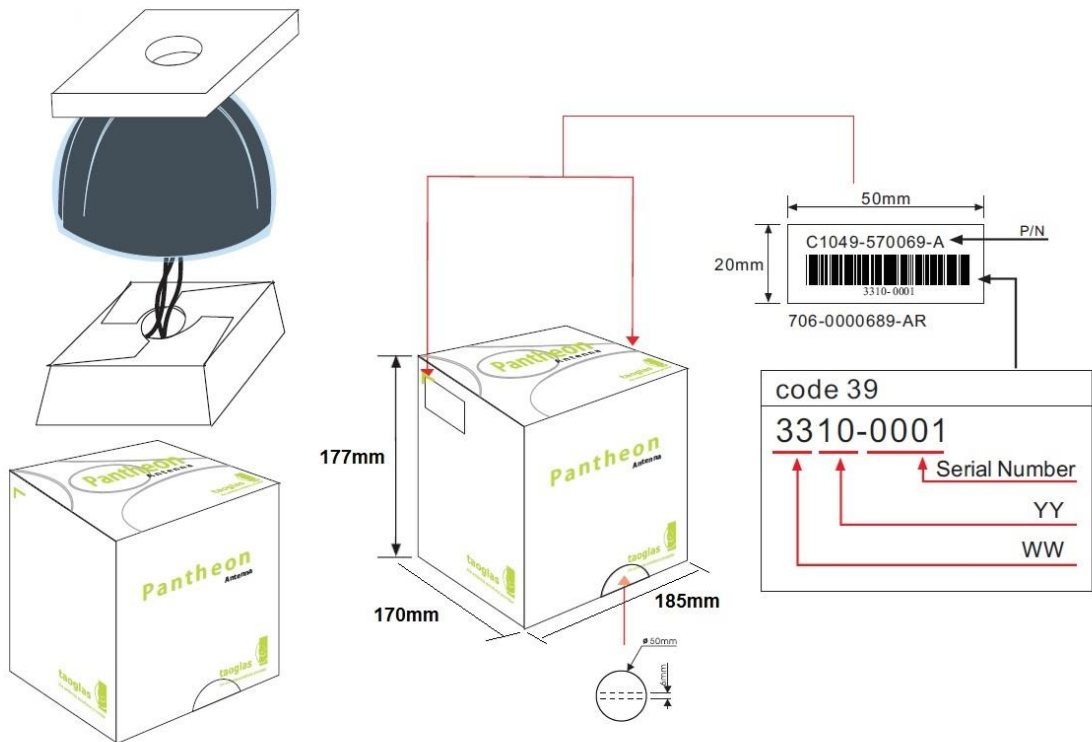

8 Individual boxes per carton

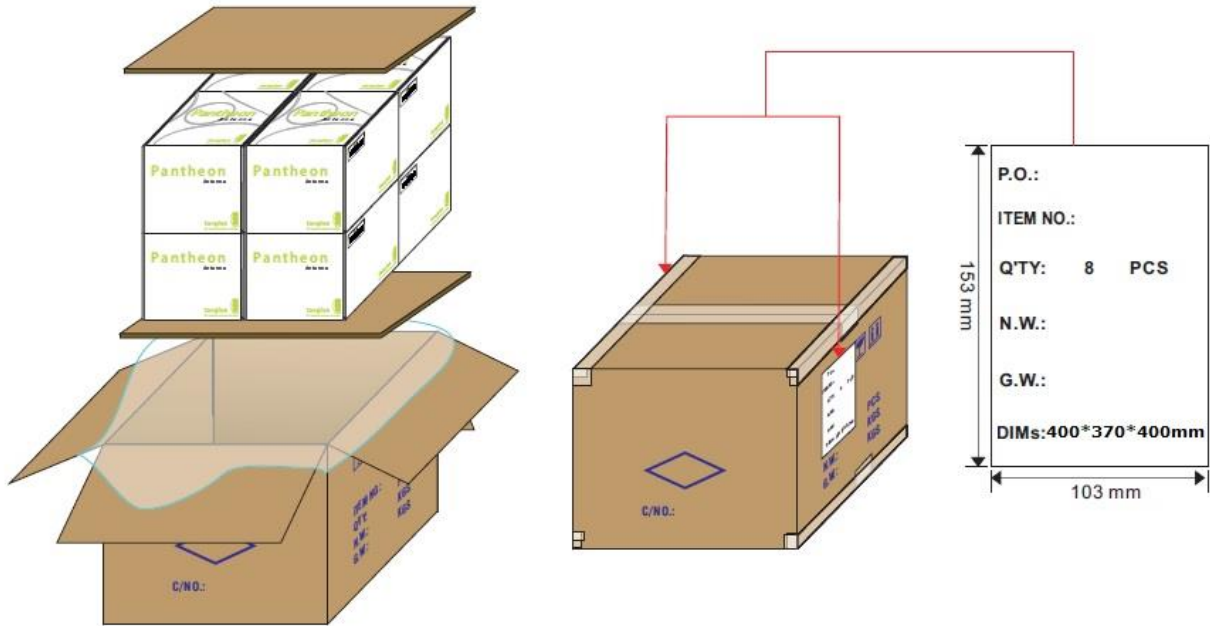

32 cartons per pallet (110*110cm)
256 pieces per pallet

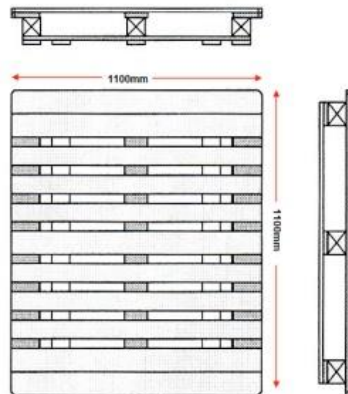

Taoglas makes no warranties based on the accuracy or completeness of the contents of this document and reserves the right to make changes to specifications and product descriptions at any time without notice. Taoglas reserves all rights to this document and the information contained herein.

Reproduction, use or disclosure to third parties without express permission is strictly prohibited.

Copyright © Taoglas Ltd.