

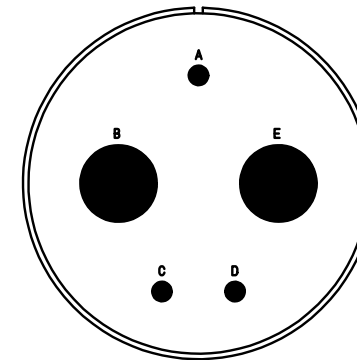

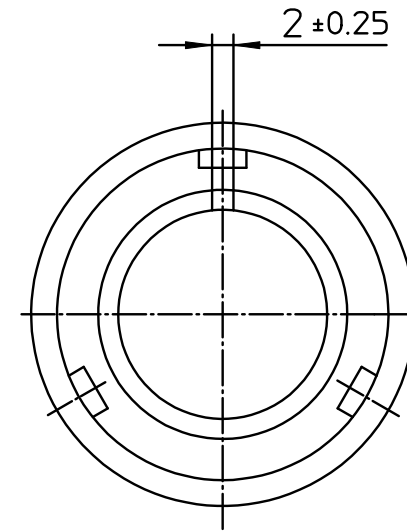

NO.	MASSE / DIMENSION
A	60.1
B	33.3
C	48
D	70



NO.	BESCHREIBUNG / DESCRIPTION
2	ISOLIERKÖRPER BUCHSE / INSULATOR SOCKET
3	DICKTKÖRPER / GROMMET
6	KONTAKTBUCHSE / CONTACT SOCKET
7	ZYLINDERGHÄUSE / BARREL
9	ÜBERWURFMUTTER / COUPLING NUT
10	DICHTRING FRONT / FRONT SEALING RING
11	SCHIRMKRANZ / SHIELDING BRAID
16	ENDGEHÄUSE GESCHIRMT / ENDBELL SHIELDED
17	REIBRING / FRICTION RING
18	WELLFEDER / WASHER

Note: Due to an automatic nomenclature system, numbers generated may not be sequential.
 Specification and Dimensions subject to change
 Drawings illustrate normal insulator positioning

Material Specification:
Shell Material: Aluminium alloy
Shell Plating: Olive drab chromate over cadmium (conductive)
Insulator Material: CR-Elastomere
Contact Material: Copper alloy
Contact Plating: Hard silver

all dimensions are in mm Dimensions without tolerance indications are general tolerances in acc. with DIN7168m	drawing for CUSTOMER
 ITT <i>Engineered for life</i> <small>ITT CANNON GmbH D - 71384 Weinstadt/Germany</small>	description CA06EW32-1S-B-15 Plug, straight shielded Shielded with spring washer, shielded heatshrink endbell AWG Crimp / Socket / Layout: 32-1
© All rights reserved. Reproduction or issue to third in any form whenever is only permitted with written authorization of ITT Cannon	page 1/1 revision 1488 30. Jul 18