

Applications

- Distributed power architectures
- Telecommunications equipment
- LAN/WAN applications
- Data processing applications

Features

- Independent outputs of any combination of voltages from 1.2V to 5.0V
- Simultaneously delivers 15A per output from 1.2V to 3.3V; 10A for 5V output
- Extremely low-profile (<8mm or 0.30") single-board design. No heatsink required.
- Light Weight: 28 g (1.00 oz)
- Surface mount and through-hole versions
- High efficiency
- No minimum load required on either output
- Starts-up into pre-biased outputs
- Meets transient withstand requirements of Bellcore GR-513
- Fixed frequency operation
- Remote on/off (primary referenced), positive or negative logic
- Output voltage trim. $\pm 10\%$ for each output
- Output overcurrent protection
- Output overvoltage protection
- Overtemperature protection

Description

The new Q2D series of dual output DC/DC converters offer unprecedented density and performance in an industry standard, quarter-brick footprint. Patent pending technology and state-of-the-art packaging techniques achieve a total of 30A (25A for 5V output) output current, 15A (10A for 5V output) per channel, without a heatsink. Extremely low profile (<8mm or 0.30") enables the converters to be used in applications where spacing between circuit boards is limited. The 100% surface-mount design provides consistent high quality and reliability. The SMT mounting option eliminates the need for separate (additional manual) process in attaching the converters to the motherboards during mass production.

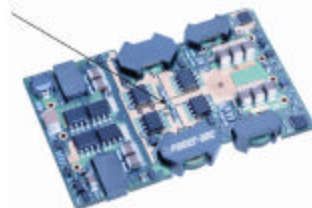

Location of the Thermocouple for Thermal Testing.



Q2D Series – Quarter-Brick DC/DC Converter
48V Input
Dual Output
Part Numbering Guide

Data Sheet

Product Series	Output Current	Input Voltage	Output Voltage 2	Output Voltage 1		ON/OFF Logic	Surface Mount	Pin Length	Height Option
Q2D	25	Z	G	E	-	N	M6		C2
Dual Quarter-Brick Format	Vout2 = 5V, Iout = 25A Vout2 < 5V Iout = 30A	48Vin Nom.	G = 5.0VDC E = 3.3VDC D = 2.5VDC	E = 3.3VDC D = 2.5VDC B = 1.8VDC Y = 1.2VDC		N ⇒ Negative (Blank) ⇒ Positive	M6 ⇒ Surface Mount (Blank) ⇒ Through Hole	Blank ⇒ 0.188" 7 ⇒ 0.145" 8 ⇒ 0.110"	See Chart Below Not Valid w/M6 Option

Base Model Selection Guide

Model	Input voltage range, VDC	Output Voltage, Vout 2 VDC	Output Voltage, Vout 1 VDC	Output Current, Output 2 ADC	Output Current, Output 1 ADC
Q2D25ZGE	36-75	5.0	3.3	10	15
Q2D25ZGD	36-75	5.0	2.5	10	15
Q2D25ZGB	36-75	5.0	1.8	10	15
Q2D30ZED	36-75	3.3	2.5	15	15
Q2D30ZEB	36-75	3.3	1.8	15	15
Q2D30ZEY	36-75	3.3	1.2	15	15
Q2D30ZDB	36-75	2.5	1.8	15	15

Height, Clearance and Pin Options for Through Hole Versions

Height Option	HT (Maximum Height)		CL (Minimum Clearance)		Pin Option	PL Pin Length	
	+0.000 [+0.00] -0.038 [- 0.97]		+0.030 [+0.77] -0.000 [- 0.00]			±0.005 [±0.13]	
blank	0.303 [7.69]		0.030 [0.77]			0.188 [4.77]	
C2	0.336 [8.53]		0.063 [1.600]		7	0.145 [3.68]	
C3	0.400 [10.16]		0.127 [3.23]		8	0.110 [2.79]	
C4	0.500 [12.70]		0.227 [5.77]				



Q2D Series – Quarter-Brick DC/DC Converter
48V Input
Dual Output

Data Sheet

Absolute Maximum Ratings

Stresses in excess of the absolute maximum ratings may cause performance degradation, adversely effect long-term reliability, and cause permanent damage to the converter.

Parameter	Conditions/Description	Min	Max	Units
Input voltage	Operating Input Voltage	0	80	VDC
	Transient, 100 ms		100	VDC
PCB Operating Temperature	At 100% load	-40	100	°C
Storage Temperature		-40	125	°C
ON/OFF Control Voltage	Referenced to -Vin	-1	13.5	VDC

Environmental and Mechanical Specifications

All specifications apply over specified input voltage, output load, and temperature range, unless otherwise noted.

Parameter	Conditions/Description	Min	Nom	Max	Units
Vibration	Halfsine wave, 10-55 Hz, 3 axes, 5 min each			5	g
Weight			1.0/28		Oz/g
Water Washing	Standard process		Yes		
MTBF	Telcordia TR -332 Method I Case 1		2.6		MHrs

Isolation Specifications

All specifications apply over specified input voltage, output load, and temperature range, unless otherwise noted.

Parameter	Conditions/Description	Min	Nom	Max	Units
Insulation Safety Rating		Basic			
Isolation Voltage		2000			VDC
Isolation Resistance		10			MΩ
Isolation Capacitance			1.3		nF

Input Specifications

All specifications apply over specified input voltage, output load and temperature range, unless otherwise noted.

Parameter	Conditions/Description	Min	Nom	Max	Units
Input Voltage	Continuous	36	48	75	VDC
Turn-On Input Voltage	Ramping Up	33	34	35	VDC
Turn-Off Input Voltage	Ramping Down	31	32	33	VDC
Turn-On Time	To Output Regulation Band 100% Resistive Load		3		mS
Input Reflected Ripple Current	Full Load, 12uH source inductance		6		mA p-p
Input Inrush Current Limit	Vin = Vin max			1	A ² s



Q2D Series – Quarter-Brick DC/DC Converter
48V Input
Dual Output

Data Sheet

Output Specifications

All specifications apply over specified input voltage, output load and temperature range, unless otherwise noted.

Parameter	Conditions/Description	Min	Nom	Max	Units
Output Voltage Setpoint Accuracy	Vin = Vin nom, Full Load	-1.5		+1.5	%Vout
Output Current* Vout1		0		15	ADC
Output Current* Vout2		0		15 10A if Vo2= 5.0	ADC
Line Regulation Vout1	Vin.min to Vin max, Iout max		+/-2		mV
Line Regulation Vout2	Vin min to Vin max, Iout max		+/-2		mV
Load Regulation, Vout1	Vin = Vnom, Iout min to Iout max		-10		mV
Load Regulation, Vout2	Vin = Vnom, Iout min to Iout max		-10		mV
Dynamic Regulation Peak Deviation Settling Time	50-75% load step change to 1% error band			40 60	mV µs
Admissible Load Capacitance	Iout max, Nom Vin			10,000	µF
Output Current Limit Threshold**	Vout=0.97Vout nom	110		160	%Iout
Switching Frequency			435		kHz
Overvoltage Protection, Non Latching	Over all input voltage and load conditions	115		140	%Vout
Trim Range	Iout max, Vin = Vnom	90		110	%Vout

** Overcurrent protection is non-latching with auto-recovery.

Feature Specifications

All specifications apply over specified input voltage, output load, and temperature range, unless otherwise noted.

Parameter	Conditions/Description	Min	Nom	Max	Units
Shutdown (ON/OFF) Negative Logic Converter ON	On/Off signal is low – converter is ON ON/OFF pin is connected to -Vin	-20		0.8	VDC
Converter OFF		2.4		20	VDC VDC
Positive Logic Converter ON	On/Off signal is low –converter is OFF	2.4		20	VDC VDC
Converter OFF	ON/OFF pin is connected to -Vin	-20		0.8	VDC mADC
Overtemperature Protection	PCB Temperature		120		°C

Start-up Information (using negative ON/OFF)

Scenario #1: Initial Start-up From Bulk Supply
 ON/OFF function enabled, converter started via application of V_{IN} . See Figure 1.

Time	Comments
t_0	ON/OFF pin is ON; system front end power is toggled on, V_{IN} to converter begins to rise.
t_1	V_{IN} crosses Under-Voltage Lockout protection circuit threshold; converter enabled.
t_2	Converter begins to respond to turn-on command (converter turn-on delay).
t_3	Output voltage V_{OUT1} reaches 100% of nominal value.
t_4	Output voltage V_{OUT2} reaches 100% of nominal value.

For this example, the total converter start-up time ($t_4 - t_1$) is typically 3ms.

Scenario #2: Initial Start-up Using ON/OFF Pin
 With V_{IN} previously powered, converter started via ON/OFF pin. See Figure 2.

Time	Comments
t_0	V_{INPUT} at nominal value.
t_1	Arbitrary time when ON/OFF pin is enabled (converter enabled).
t_2	End of converter turn-on delay.
t_3	Output voltage V_{OUT1} reaches 100% of nominal value.
t_4	Output voltage V_{OUT2} reaches 100% of nominal value.

For this example, the total converter start-up time ($t_4 - t_1$) is typically 3ms.

Scenario #3: Turn-off and Restart Using ON/OFF Pin

With V_{IN} previously powered, converter is disabled and then enabled via ON/OFF pin. See Figure 3.

Time	Comments
t_0	V_{IN} and V_{OUT} are at nominal values; ON/OFF pin ON.
t_1	ON/OFF pin arbitrarily disabled; converter outputs fall to zero; turn-on inhibit delay period (100ms typical) is initiated, and ON/OFF pin action is internally inhibited.
t_2	ON/OFF pin is externally re-enabled. If $(t_2 - t_1) = 100\text{ms}$, external action of ON/OFF pin is locked out by start-up inhibit timer. If $(t_2 - t_1) > 100\text{ms}$, ON/OFF pin action is internally enabled.
t_3	Turn-on inhibit delay period ends. If ON/OFF pin is ON, converter begins turn-on; if off, converter awaits ON/OFF pin ON signal; see Figure 6.
t_4	End of converter turn-on delay.

- t_5 Output voltage V_{OUT1} reaches 100% of nominal value.
- t_6 Output voltage V_{OUT2} reaches 100% of nominal value.

For the condition, $(t_2 - t_1) = 100\text{ms}$, the total converter start-up time ($t_6 - t_2$) is typically 103ms. For $(t_2 - t_1) > 100\text{ms}$, start-up time will be typically 3ms after release of ON/OFF pin.

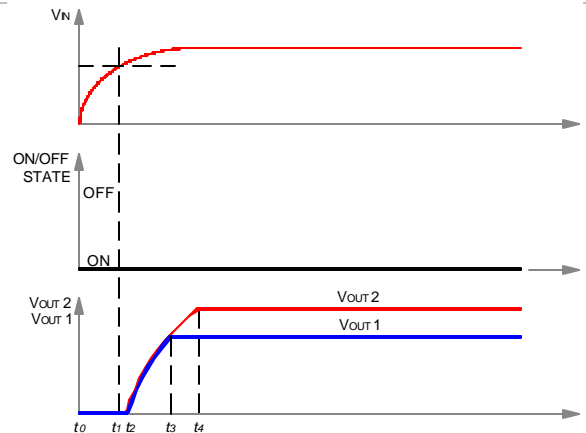

Fig. 1. Start-up Scenario #1

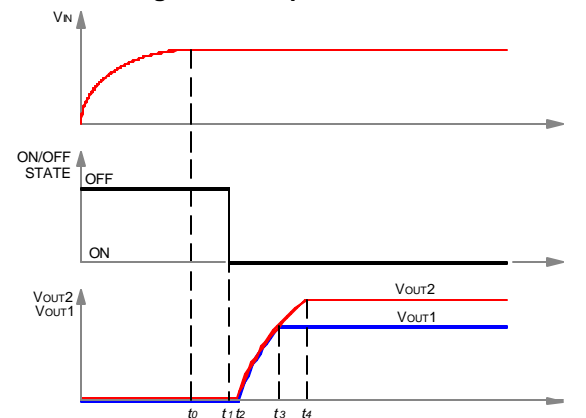

Fig. 2. Start-up Scenario #2

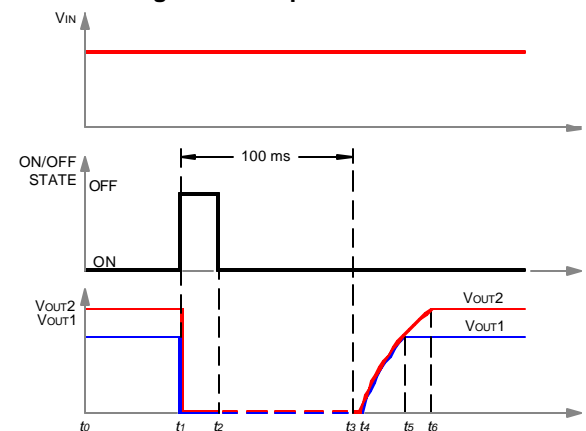

Fig. 3. Start-up Scenario #3

Characteristic curves

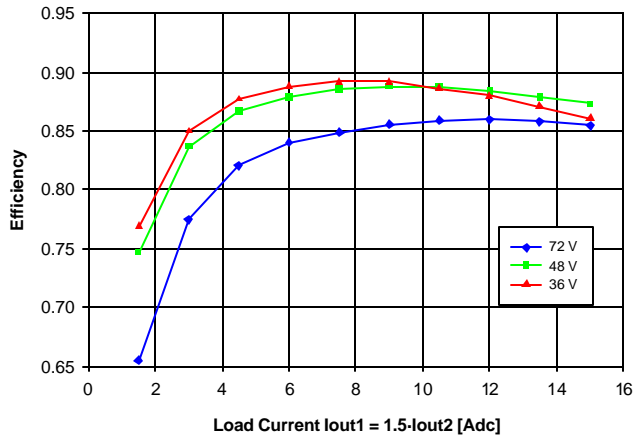

Fig. 4. Q2D25ZGE (5.0V/3.3V), Balanced Load

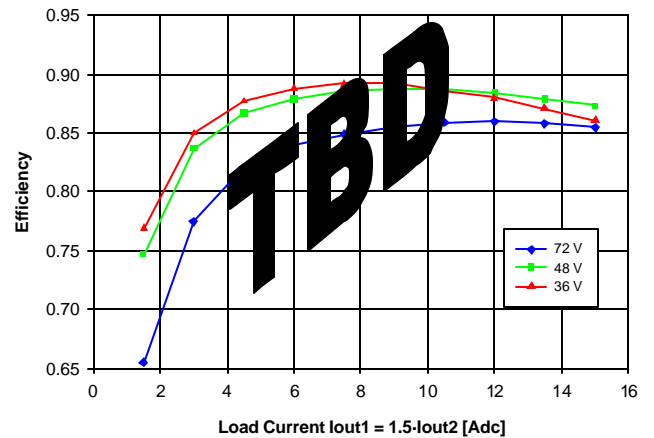

Fig. 7. Q2D25ZGD (5.0V/2.5V), Balanced Load

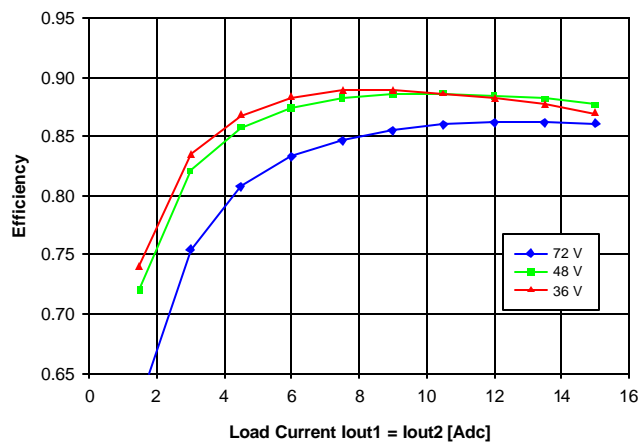

Fig. 5. Q2D30ZED (3.3V/2.5V), Balanced Load

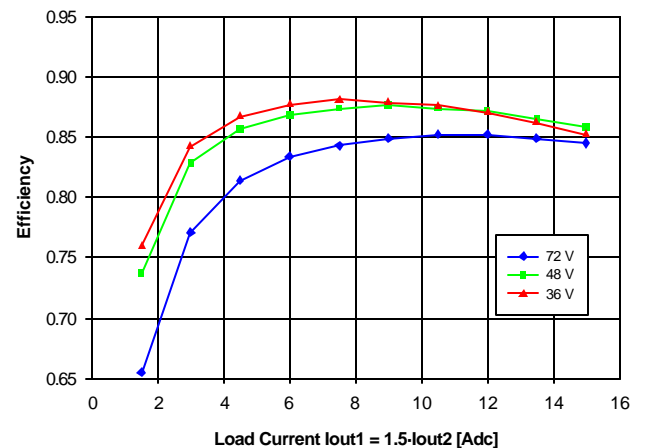

Fig. 8. Q2D25ZGB (5.0V/1.8V), Balanced Load

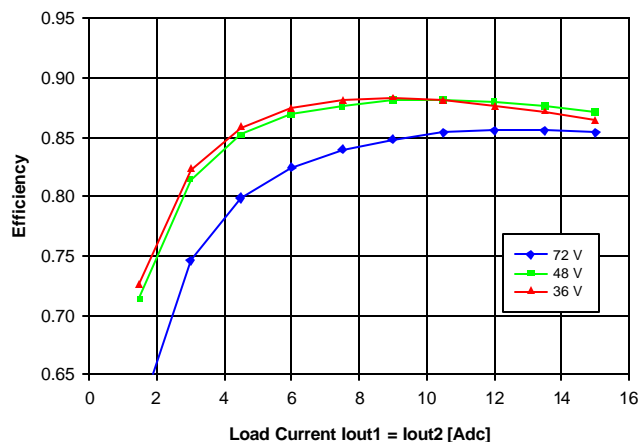

Fig. 6. Q2D30ZEB (3.3V/1.8V), Balanced Load

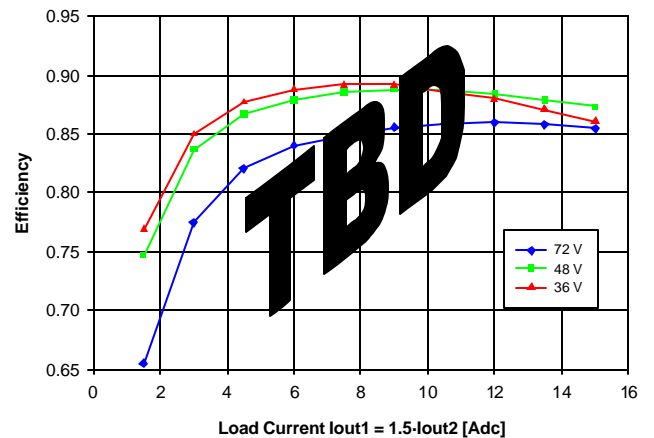

Fig. 9. Q2D25ZDB (2.5V/1.8V), Balanced Load

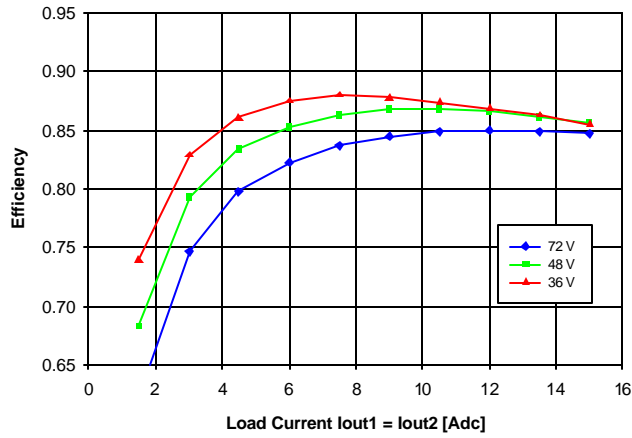

Fig. 10. Q2D30ZEY (3.3V/1.2V), Balanced Load

Application

Input and Output Impedance

These power converters have been designed to be stable with no external capacitors when used in low inductance input and output circuits.

However, in many applications, the inductance associated with the distribution from the power source to the input of the converter can affect the stability of the converter. The addition of a 33 μF electrolytic capacitor with an ESR $< 1 \Omega$ across the input helps ensure stability of the converter. In many applications, the user has to use decoupling capacitance at the load. The converter will exhibit stable operation with external load capacitance up to 10,000 μF on 3.3 V and 4,700 μF on 5 V output.

ON/OFF (Pin 2)

The ON/OFF pin is used to turn the power converter on or off remotely via a system signal. There are two remote control options available, positive logic and negative logic and both are referenced to $V_{in(-)}$. Typical connections are shown in Fig. 11.

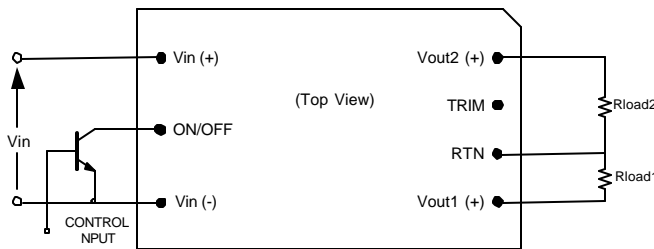

Fig. 11. Circuit Configuration for ON/OFF Function

The positive logic version turns on when the ON/OFF pin is at logic high and turns off when at logic low. The converter is on when the ON/OFF pin is left open.

The negative logic version turns on when the pin is at logic low and turns off when the pin is at logic high. The ON/OFF pin can be hard wired directly to $V_{in(-)}$ to enable automatic power up of the converter without the need of an external control signal.

A mechanical switch, open collector transistor, or FET can be used to drive the input of the ON/OFF pin. The device must be capable of sinking up to

0.2 mA at a low level voltage of $\leq 0.8 \text{ V}$, and sourcing up to 0.5 mA at high logic level of 5 V; higher current capability is required for control voltages greater than 5 V. See the Start-up Information section for system timing waveforms associated with use of the ON/OFF pin.

Output Voltage Adjust /TRIM (Pin 6)

The converter's output voltages can be adjusted simultaneously up 10% or down 10% relative to the rated output voltages by the addition of an externally connected resistor.

The TRIM pin should be left open if trimming is not being used. To minimize noise pickup, a 0.1 μF capacitor is connected internally between the TRIM and RETURN pins.

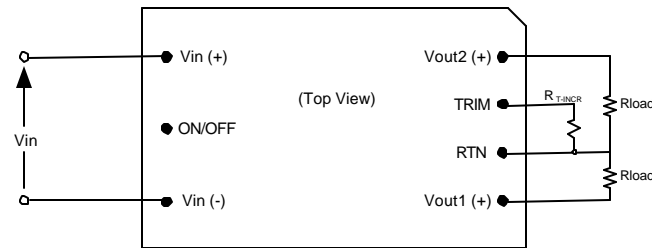

Fig. 12. Configuration for Increasing Output Voltage

To increase the output voltage (refer to Fig. 12), a trim resistor, R_{T-INCR} , should be connected between the TRIM (Pin 6) and RETURN (Pin 5), with a value from the tables below.

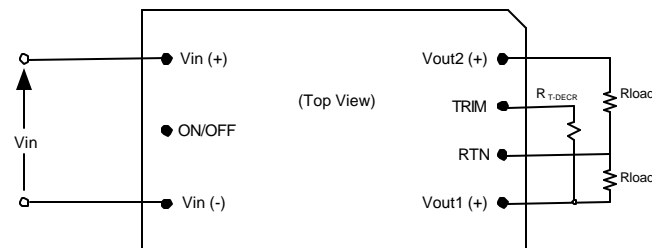

Fig. 13A. Configuration for Decreasing Output Voltage

To decrease the output voltage, a trim resistor R_{T-DECR} , (Fig. 13A) should be connected between the TRIM (Pin 6) and $V_{out1}(+)$ pin (Pin 4), with a value from the tables below, where:

? = percentage of increase or decrease $V_{out}(NOM)$.

Q2D Series – Quarter-Brick DC/DC Converter

48V Input

Dual Output

Models using the trim configuration shown in figure 13A include: Q2D25ZGE, Q2D25ZGB, Q2D30ZED.

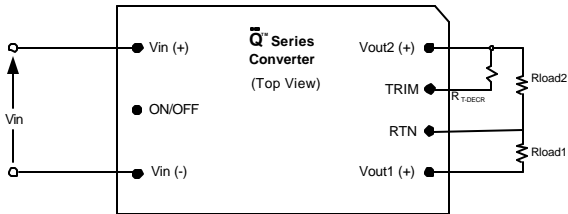

Fig. 13B. Configuration for decreasing output voltage

To decrease the output voltage, a trim resistor R_{T-DECR} , (Fig. 13B) should be connected between the TRIM (Pin 6) and Vout2(+) pin (Pin 7), with a value from the table below, where:

? = percentage of increase or decrease Vout(NOM).

Models using the trim configuration shown in figure 13B include: Q2D30ZEB, Q2D30ZEY, Q2D30ZDB, Q2D30ZBA.

Note 1: Both outputs are trimmed up or down simultaneously.

Trim Resistor (Vout Increase)		Trim Resistor (Vout Decrease)	
? [%]	R_{T-INC} [k Ω]	? [%]	R_{T-DECR} [k Ω]
1	54.9	-1	68.1
2	24.9	-2	30.1
3	14.3	-3	17.8
4	9.31	-4	11.5
5	6.34	-5	7.68
6	4.32	-6	5.36
7	2.80	-7	3.48
8	1.69	-8	2.10
9	0.825	-9	1.05
10	0	-10	0

Table A. Use for models: Q2D25ZGE, Q2D25ZGB, Q2D30ZEB, Q2D30ZEY.

Trim Resistor (Vout Increase)		Trim Resistor (Vout Decrease)	
? [%]	R_{T-INC} [k Ω]	? [%]	R_{T-DECR} [k Ω]
1	46.4	-1	57.6
2	20.5	-2	25.5
3	12.1	-3	14.0
4	8.06	-4	8.87
5	5.23	-5	5.90
6	3.57	-6	3.83
7	2.21	-7	2.32
8	1.30	-8	1.30
9	0.604	-9	0.432
10	0	-10	0

Table B. Use for models: Q2D30ZED, Q2D30ZDB

Trim Resistor (Vout Increase)		Trim Resistor (Vout Decrease)	
? [%]	R_{T-INC} [k Ω]	? [%]	R_{T-DECR} [k Ω]
1	60.4	-1	28.7
2	29.4	-2	13.3
3	19.6	-3	8.45
4	14.3	-4	5.90
5	11.3	-5	4.32
6	9.31	-6	3.40
7	7.87	-7	2.67
8	6.81	-8	2.10
9	5.90	-9	1.69
10	5.23	-10	1.37

Table C. Use for models Q2D30ZBA

Note 2: The above trim resistor values match those typically used in industry-standard dual quarter bricks.

Input Under-Voltage Lockout

Input under-voltage lockout is standard with this converter. The converter will shut down when the input voltage drops below a predetermined voltage.

The input voltage must be at least 35V for the converter to turn on. Once the converter has been turned on, it will shut off when the input voltage drops below 31V. This feature is beneficial in preventing deep discharging of batteries used in telecom applications.

Output Over-Current Protection (OCP)

The converter is protected against over-current or short circuit conditions on both outputs. Upon sensing an over-current condition, the converter will switch to constant current operation and thereby begin to reduce output voltages. If, due to current limit, the output voltage Vout1 (3.3V) drops, then Vout2 (5.0V) will follow Vout1 with less than 1V difference. Drop on Vout2 output due to current limit will not affect voltage on Vout1. For further load increase, if either Vout1 drops below 1 Vdc or Vout2 drops below 2 Vdc, the converter will shut down.

Once the converter has shut down, it will attempt to restart nominally every 100ms with a 2% duty cycle. The attempted restart will continue indefinitely until the overload or short circuit conditions are removed or the output voltage Vout1 rises above 1 Vdc and Vout2 above 2 Vdc.

Output Over-Voltage Protection (OVP)

The converter will shut down if the output voltage across either Vout1(+) (Pin 4) or Vout2(+) (Pin 7) and RETURN (Pin 5) exceeds the threshold of the OVP circuitry. The OVP protection is separate for Vout1 and Vout2 with their own reference independent of the output voltage regulation loops. Once the converter has shut down, it will attempt to restart every 100ms until the OVP condition is removed.

Over-Temperature Protection (OTP)

The converter will shut down under an over-temperature condition to protect itself from overheating caused by operation outside the thermal derating curves, or operation in abnormal conditions such as system fan failure.

The over-temperature protection circuit turns the converter off when the temperature at a sensed location reaches 120°C (typical). Once the converter has shut down, it will restart when the temperature at the sensed location falls below 110°C.

Safety Requirements

The converters meet North American and International safety regulatory requirements per

UL60950 and EN60950. Basic Insulation is provided between input and output.

To comply with safety agencies requirements, an input line fuse must be used external to the converter. A 5-A fuse is recommended for use with this product.

Electromagnetic Compatibility (EMC)

EMC requirements must be met at the end-product system level, as no specific standards dedicated to EMC characteristics of board mounted component DC/DC converters exist. However, Power-One tests its converters to several system level standards, primary of which is the more stringent EN55022, *Information technology equipment - Radio disturbance characteristics - Limits and methods of measurement*.

With the addition of a simple external filter (see application notes), all versions of the Q2D family of converters pass the requirements of Class B conducted emissions per EN55022 and FCC, and meet at a minimum, Class A radiated emissions per EN 55022 and Class B per FCC Title 47CFR, Part 15-J. Please contact Power-One Applications Engineering for testing details.

Thermal Considerations

The Q2D series converters are designed for natural or forced convection cooling. The maximum available output power of the converters is determined by the maximum semiconductor junction temperature. To provide reliable long-term operation of the converters, Power-One limits maximum allowable junction temperature to 120°C.

The graphs in Figures 14-20 show the maximum output current of the Q2D series converters at different local ambient temperatures at both natural and forced (longitudinal airflow direction, from pin 3 to pin 4) convection.

lout1=lout2 for all derating curves.

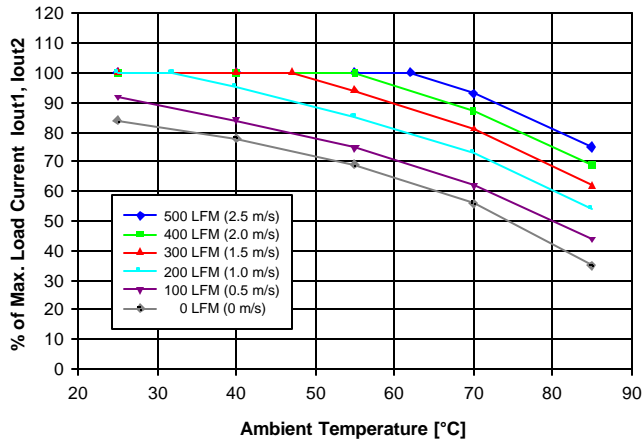

Fig.14. Q2D25ZGE (5.0V/3.3V) Derating Curves

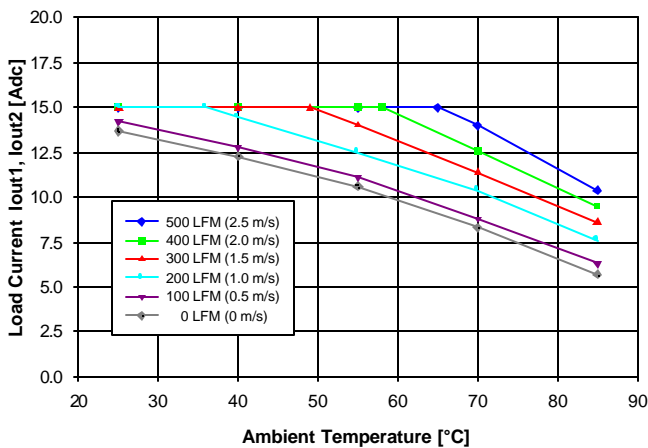

Fig.15. Q2D25ZGD (5.0V/2.5V) Derating Curves

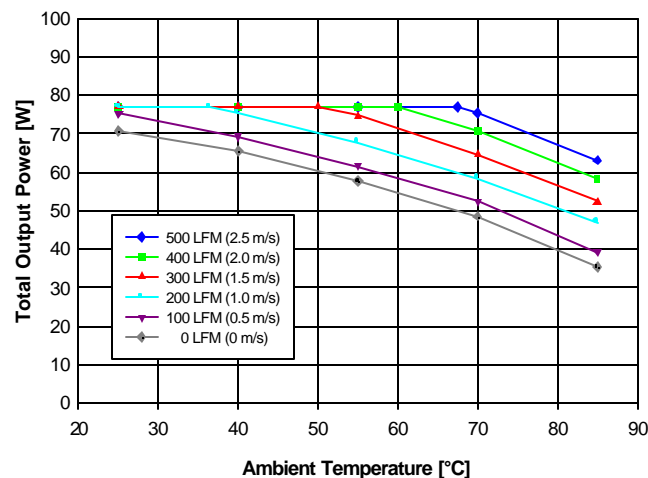

Fig.16. Q2D25ZGB (5.0V/1.8V) Derating Curves

Rev. NOV 13, 2002

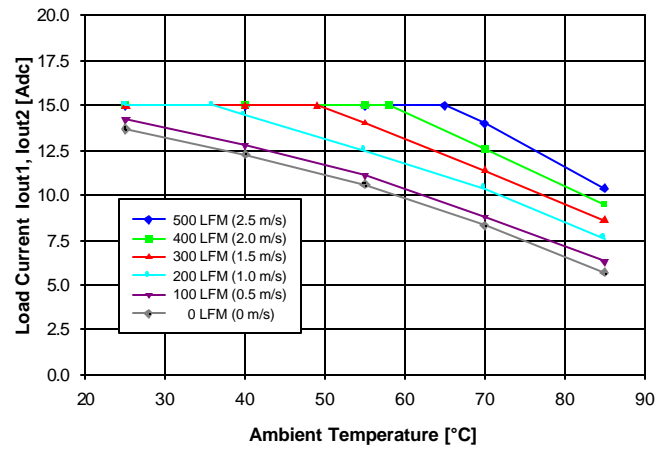

Fig.17. Q2D30ZED (3.3V/2.5V) Derating Curves

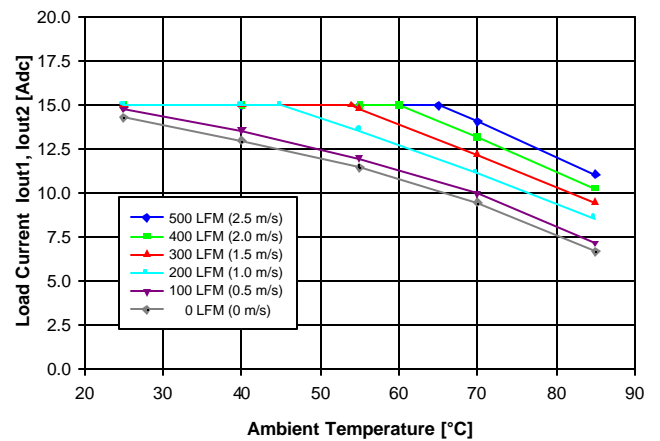

Fig.18. Q2D30ZEB (3.3V/1.8V) Derating Curves

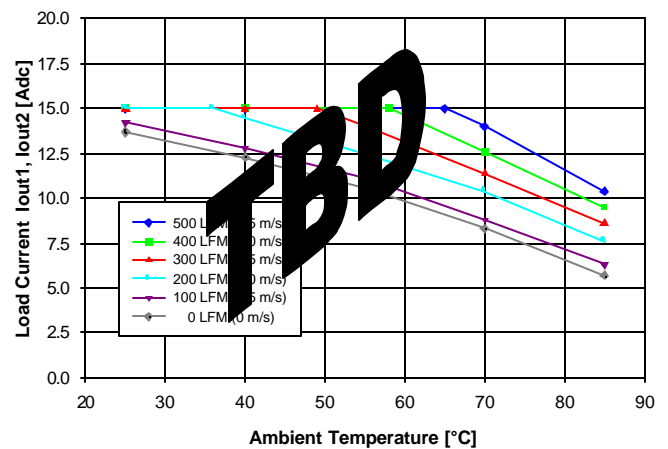

Fig.19. Q2D30ZDB (2.5V/1.8V) Derating Curves

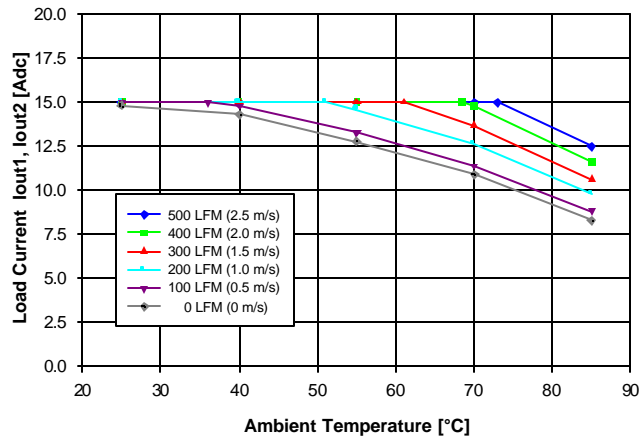
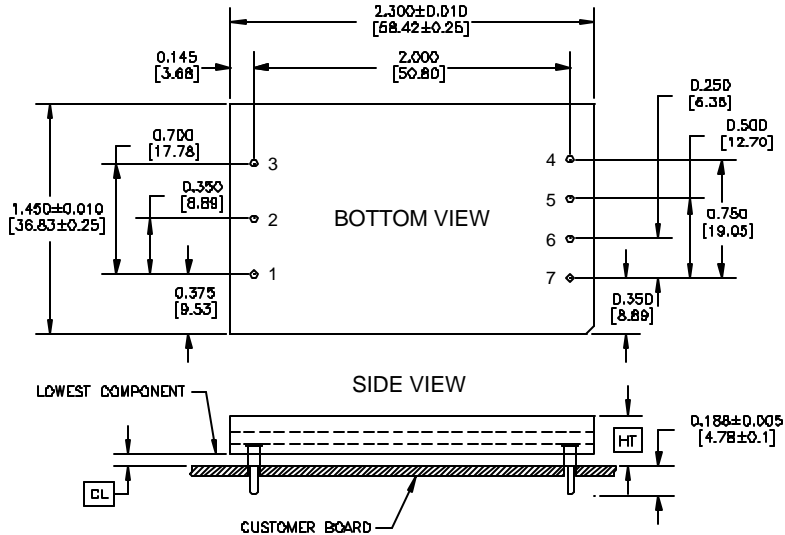

Fig.20. Q2D30ZEY (3.3V/1.2V) Derating Curves

Physical Information (Through-Hole option)



Pin Connections	
Pin #	Function
1	Vin (+)
2	ON/OFF
3	Vin (-)
4	Vout1 (+)
5	RTN [Vout1(-) and Vout2(-)]
6	TRIM
7	Vout2 (+)

- All dimensions are in inches [mm]
- All pins are $\varnothing 0.040$ " [1.02] with $\varnothing 0.078$ " [1.98] shoulder
- Pin material: Brass
- Pin Finish: Tin/Lead over Nickel
- Converter weight: 0.90 oz. [25.5 g]

Height Option	HT (Maximum Height)	CL (Minimum Clearance)
	+0.000 [+0.00] -0.038 [- 0.97]	+0.030 [+0.77] -0.000 [- 0.00]
blank	0.303 [7.69]	0.030 [0.77]
C2	0.336 [8.53]	0.063 [1.600]
C3	0.400 [10.16]	0.127 [3.23]
C4	0.500 [12.70]	0.227 [5.77]

Pin Option	PL Pin Length
	± 0.005 [± 0.13]
7	0.188 [4.77]
8	0.145 [3.68]
	0.110 [2.79]

Physical Information (Surface Mount option)

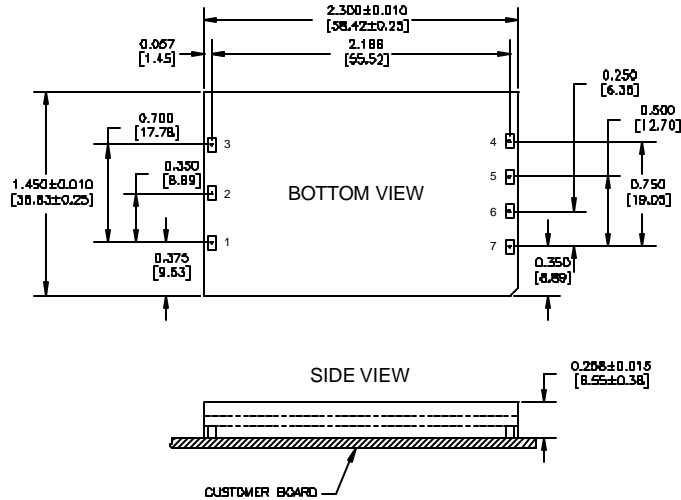

Pin Connections	
Pin #	Function
1	Vin (+)
2	ON/OFF
3	Vin (-)
4	Vout1 (+)
5	RTN [Vout1(-) and Vout2(-)]
6	TRIM
7	Vout2 (+)

- All dimensions are in inches [mm]
- Connector material: Copper
- Connector Finish: Gold over Nickel
- Converter weight: 0.90 oz. [25.5 g]
- Recommended Surface-Mount Pads:
 Min. 0.080" x 0.112" [2.03 x 2.84]
 Max. 0.092" x 0.124" [2.34 x 3.15]

Notes

1. Consult factory for the complete list of available options.
2. Power-One products are not authorized for use as critical components in life support systems, equipment used in hazardous environments, or nuclear control systems without the express written consent of the respective divisional president of Power-One, Inc.
3. The appearance of products, including safety agency certifications pictured on labels, may change depending on the date manufactured. Specifications are subject to change without notice.
4. Valid output voltage combinations

Vout2	Vout1 (Given Vout2 listed below are the Vout1 possibilities)
5.0V	3,3, 2.5, 1.8
3.3V	2.5, 1.8, 1.2
2.5V	1.8