

# SMA 50 Ohm Straight Solder Type Bulkhead Jack

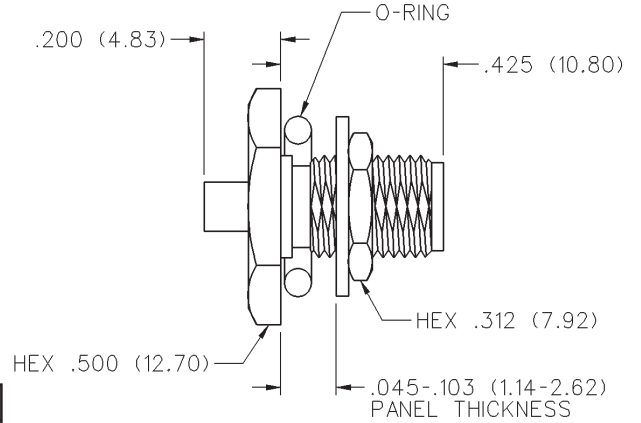

INCHES (MILLIMETERS)  
CUSTOMER DRAWINGS AVAILABLE UPON REQUEST



CABLE TYPE	VSWR & FREQ. RANGE	GOLD PLATED	NICKEL PLATED
.086 Semi-Rigid	0-18 GHz: 1.07 + .008 f (GHz) 26.5 GHz: 1.35 Max	142-0593-401	142-0593-406

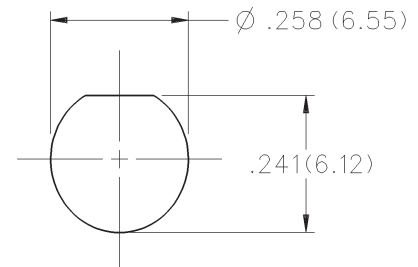
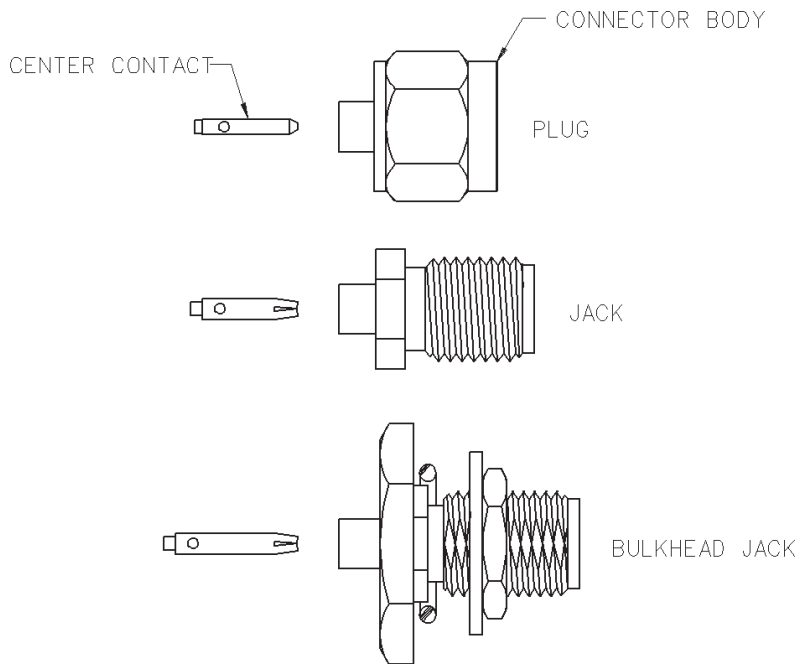

Mounting hole layout

CABLE GROUP	PART NUMBER	"A"
RG-402/u (.141 semi-rigid)	142-0594-401/406	.085 (2.16)

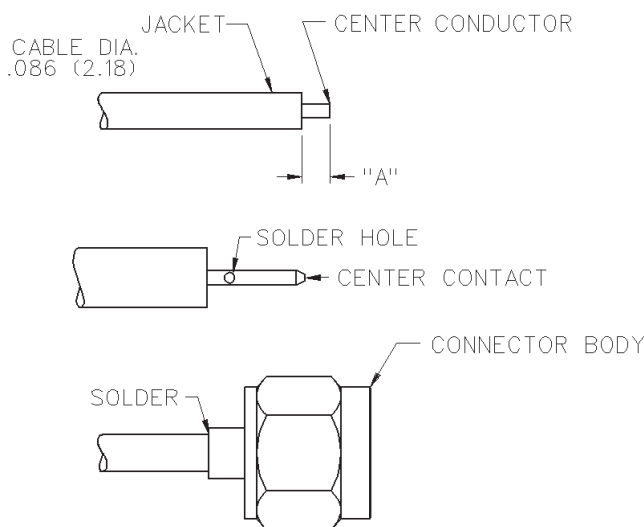

1. Identify connector parts. (2 piece parts)
2. Strip cable to dimensions shown. Do not nick center conductor.
3. Place center contact on center conductor making sure contact bottoms against cable insulation. Solder center conductor to center contact through solder hole. Solder **must not** be allowed to run on outside of contact. Use a minimum amount of solder for a good joint. **.020 (0.51) diameter solder is recommended.** Trim excess insulation.
4. Insert contact and cable into body assembly making sure cable is bottomed against insulator in body. Solder body to cable. Use a minimum amount of heat to minimize cable insulation movement.

# SMA - 50 Ohm Connectors

Specifications



INCHES (MILLIMETERS)  
CUSTOMER DRAWINGS AVAILABLE UPON REQUEST

## ELECTRICAL RATINGS

**Impedance:** 50 ohms

**Frequency Range:**

Dummy loads .....	0-2 GHz
Flexible cable connectors .....	0-12.4 GHz
Uncabled receptacles, RA semi-rigid and adapters .....	0-18.0 GHz
Straight semi-rigid cable connectors and field replaceable connectors .....	0-26.5 GHz

**VSWR:** (f = GHz)

	Straight Cabled Connectors	Right Angle Cabled Connectors
RG-178 cable .....	1.20 + .025f	1.20 + .03f
RG-316, LMR-100 cable .....	1.15 + .02f	1.15 + .03f
RG-58, LMR-195 cable .....	1.15 + .01f	1.15 + .02f
RG-142 cable .....	1.15 + .01f	1.15 + .02f
LMR-200, LMR-240 cable .....	1.10 + .03f	1.10 + .06f
.086 semi-rigid .....	1.07 + .008f	1.18 + .015f
.141 semi-rigid (w/contact) .....	1.05 + .008f	1.15 + .015f
.141 semi-rigid (w/o contact) .....	1.035 + .005f	
Jack-bulkhead jack adapter and plug-plug adapter .....	1.05 + .01f	
Jack-jack adapter and plug-jack adapter .....	1.05 + .005f	
Uncabled receptacles, dummy loads .....	N/A	
Field replaceable (see page 59) .....	N/A	

**Working Voltage:** (Vrms maximum)

Connectors for Cable Type	Sea Level	70K Feet
RG-178 .....	170	45
RG-316; LMR-100, 195, 200 .....	250	65
RG-58, RG-142, LMR-240, .086 semi-rigid, uncabled receptacles, .141 semi-rigid w/o contact ...	335	85
.141 semi-rigid with contact and adapters .....	500	125
Dummy loads .....	N/A	

**Dielectric Withstanding Voltage:** (VRMS minimum at sea level)

Connectors for RG-178 .....	500
Connectors for RG-316; LMR-100, 195, 200 .....	750
Connectors for RG-58, RG-142, LMR-240, .086 semi-rigid, field replaceable, uncabled receptacles .....	1000
Connectors for .141 semi-rigid with contact and adapters .....	1500
Connectors for .141 semi-rigid w/o contact, dummy loads .....	N/A

**Corona Level:** (Volts minimum at 70,000 feet)

Connectors for RG-178 .....	125
Connectors for RG-316; LMR-100, 195, 200 .....	190
Connectors for RG-58, RG-142, LMR-240, .086 semi-rigid, uncabled receptacles, .141 semi-rigid w/o contact .....	250
Connectors for .141 semi-rigid with contact and adapters .....	375
Dummy loads .....	N/A

**Insertion Loss:** (dB maximum)

Straight flexible cable connectors and adapters .....	0.06	$\sqrt{f}$ (GHz), tested at 6 GHz
Right angle flexible cable connectors .....	0.15	$\sqrt{f}$ (GHz), tested at 6 GHz
Straight semi-rigid cable connectors with contact .....	0.03	$\sqrt{f}$ (GHz), tested at 10 GHz
Right angle semi-rigid cable connectors .....	0.05	$\sqrt{f}$ (GHz), tested at 10 GHz
Straight semi-rigid cable connectors w/o contact .....	0.03	$\sqrt{f}$ (GHz), tested at 16 GHz
Straight low loss flexible cable connectors .....	0.06	$\sqrt{f}$ (GHz), tested at 1 GHz
Right Angle low loss flexible cable connectors .....	0.15	$\sqrt{f}$ (GHz), tested at 1 GHz
Uncabled receptacles, field replaceable, dummy loads .....		N/A

**Insulation Resistance:** 5000 megohms minimum

**Contact Resistance:** (milliohms maximum) **Initial** **After Environmental**

Center contact (straight cabled connectors and uncabled receptacles) .....	3.0*	4.0*
Center contact (right angle cabled connectors and adapters) .....	4.0	6.0
Field replaceable connectors .....	6.0	8.0
Outer contact (all connectors) .....	2.0	N/A
Braid to body (gold plated connectors) .....	0.5	N/A
Braid to body (nickel plated connectors) .....	5.0	N/A

\*N/A where the cable center conductor is used as a contact

**RF Leakage:** (dB minimum, tested at 2.5 GHz)

Flexible cable connectors, adapters and .141 semi-rigid connectors w/o contact .....	-60 dB
Field replaceable w/o EMI gasket .....	-70 dB
.086 semi-rigid connectors and .141 semi-rigid connectors with contact, and field replaceable with EMI Gasket .....	-90 dB
Two-way adapters .....	-90 dB
Uncabled receptacles, dummy loads .....	N/A

**RF High Potential Withstanding Voltage:** (Vrms minimum, tested at 4 and 7 MHz)

Connectors for RG-178 .....	335
Connectors for RG-316; LMR-100, 195, 200 .....	500
Connectors for RG-58, RG-142, LMR-240, .086 semi-rigid, .141 semi-rigid cable w/o contact, uncabled receptacles .....	670
Connectors for .141 semi-rigid with contact and adapters .....	1000

**Power Rating (Dummy Load):** 0.5 watt @ + 25°C, derated to 0.25 watt @ +125°C

## MECHANICAL RATINGS

**Engagement Design:** MIL-C-39012, Series SMA

**Engagement/Disengagement Force:** 2 inch-pounds maximum

**Mating Torque:** 7 to 10 inch-pounds

**Bulkhead Mounting Nut Torque:** 15 inch-pounds

**Coupling Proof Torque:** 15 inch-pounds minimum

**Coupling Nut Retention:** 60 pounds minimum

**Contact Retention:**

6 lbs. minimum axial force (captivated contacts)

4 inch-ounce minimum torque (uncabled receptacles)

**Cable Retention:**

	Axial Force*(lbs)	Torque (in-oz)
Connectors for RG-178 .....	10	N/A
Connectors for RG-316, LMR-100 .....	20	N/A
Connectors for LMR-195, 200 .....	30	N/A
Connectors for RG-58, LMR-240 .....	40	N/A
Connectors for RG-142 .....	45	N/A
Connectors for .086 semi-rigid .....	30	16
Connectors for .141 semi-rigid .....	60	55

\*Or cable breaking strength whichever is less.

**Durability:** 500 cycles minimum

100 cycles minimum for .141 semi-rigid connectors w/o contact

**ENVIRONMENTAL RATINGS** (Meets or exceeds the applicable paragraph of MIL-C-39012)

**Temperature Range:** - 65°C to + 165°C

**Thermal Shock:** MIL-STD-202, Method 107, Condition B

**Corrosion:** MIL-STD-202, Method 101, Condition B

**Shock:** MIL-STD-202, Method 213, Condition I

**Vibration:** MIL-STD-202, Method 204, Condition D

**Moisture Resistance:** MIL-STD-202, Method 106

†Avoid user injury due to misapplication. See safety advisory definitions inside front cover.

Cinch Connectivity Solutions

299 Johnson Avenue SW, Waseca, MN 56093 USA • 800.247.8256 • +1 507 833 8822 • cinchconnectivity.com

# SMA - 50 Ohm Connectors

Specifications



INCHES (MILLIMETERS)  
CUSTOMER DRAWINGS AVAILABLE UPON REQUEST

## MATERIAL SPECIFICATIONS

**Bodies:** Brass per QQ-B-626, gold plated\* per MIL-G-45204 .00001" min. or nickel plated per QQ-N-290

**Contacts:** Male - brass per QQ-B-626, gold plated per MIL-G-45204 .00003" min.

Female - beryllium copper per QQ-C-530, gold plated per MIL-G-45204 .00003" min.

**Nut Retention Spring:** Beryllium copper per QQ-C-533. Unplated

**Insulators:** PTFE fluorocarbon per ASTM D 1710 and ASTM D 1457 or Tefzel per ASTM D 3159 or PFA 340 per ASTM

**Expansion Caps:** Brass per QQ-B-613, gold plated per MIL-G-45204 .00001" min. or nickel plated per QQ-N-290

**Crimp Sleeves:** Copper per WW-T-799 or brass per QQ-B-613, gold plated per MIL-G-45204 .00001" min. or nickel plated per QQ-N-290

**Mounting Hardware:** Brass per QQ-B-626 or QQ-B-613, gold plated per MIL-G-45204 .00001" min. or nickel plated per QQ-N-290

**Seal Rings:** Silicone rubber per ZZ-R-765

**EMI Gaskets:** Conductive silicone rubber per MIL-G-83528, Type M

\* All gold plated parts include a .00005" min. nickel underplate barrier layer.

### Mating Engagement for SMA Series per MIL-C-39012

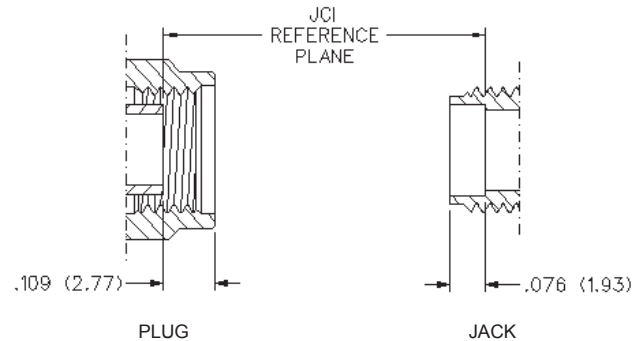
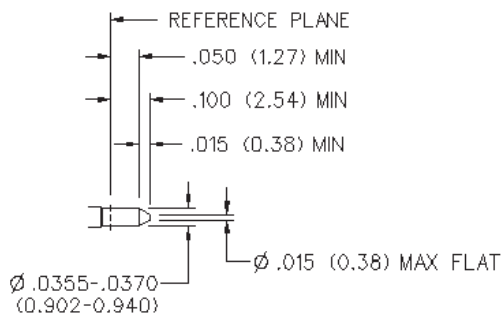
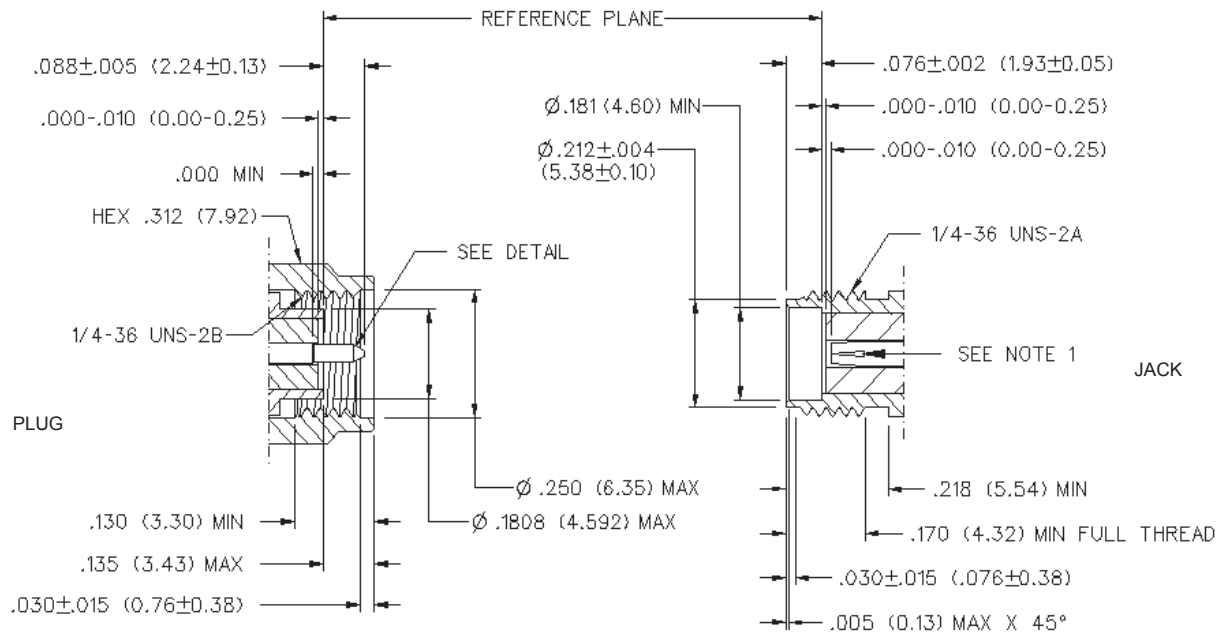

#### NOTES

1. ID OF CONTACT TO MEET VSWR, CONTACT RESISTANCE AND INSERTION WITHDRAWAL FORCES WHEN MATED WITH DIA. .0355-.0370 MALE PIN.

**Cinch Connectivity Solutions**

299 Johnson Avenue SW, Waseca, MN 56093 USA • 800.247.8256 • +1 507 833 8822 • cinchconnectivity.com