

#### MIRELLA-50-S-PIN

~15° spot beam

#### TECHNICAL SPECIFICATIONS:

Dimensions	Ø 49.9 mm
Height	23.9 mm
Fastening	pin
Colour	metal
Box size	480 x 280 x 300 mm
Box weight	2.7 kg
Quantity in Box	336 pcs
ROHS compliant	yes ⓘ



#### MATERIAL SPECIFICATIONS:

Component	Type	Material	Colour	Coating
MIRELLA-50-S-PIN	Reflector	PC	metal	lacquer

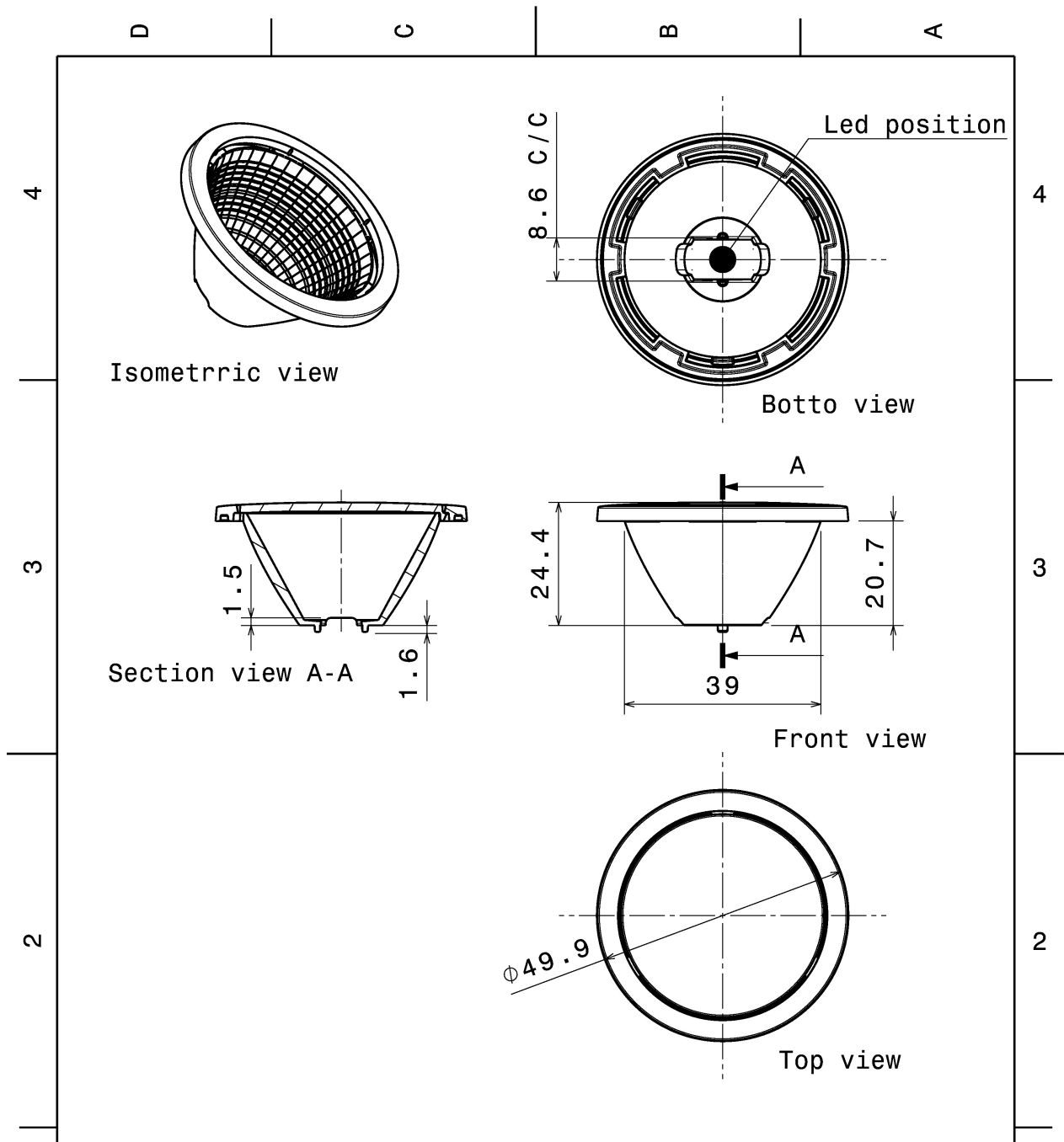

Tolerances if not otherwise shown  
According to DIN ISO 2768-1  
Linear measures:  
Up to 30mm class M, otherwise class C.  
According to DIN ISO 2768-2  
Form and position: class L

**LEDiL** Oy  
Salorankatu 10  
FIN 24240 SALO  
Finland

THIRD ANGLE PROJECTION:





DRAWING TITLE  
**Datasheet\_Mirella\_pin**

This drawing is the property of LEDiL Oy. It may not be reproduced, copied or communicated without a written agreement with LEDiL Oy."

SIZE	PART NUMBER
A4	-

SCALE	1:1	WEIGHT	-	SHEET	1/1
-------	-----	--------	---	-------	-----

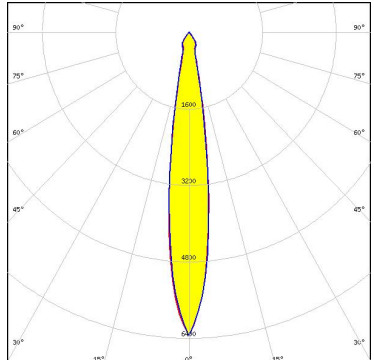
**PHOTOMETRIC DATA (MEASURED):**

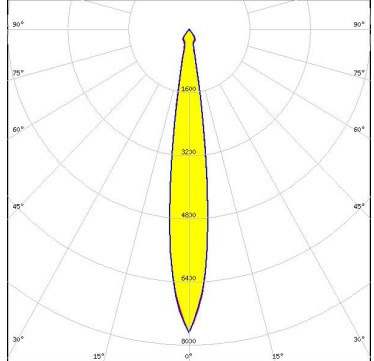
<p>bridgelux.</p> <p>LED SM4 FWHM 15.0° Efficiency 81 % Peak intensity 6.930 cd/lm Required components: C12479_MIRELLA-DL</p>		
<p><b>CREE</b> ⇄</p> <p>LED MHB-A/B FWHM 14.0° Efficiency 90 % Peak intensity 9.360 cd/lm Required components:</p>		
<p><b>CREE</b> ⇄</p> <p>LED MHB-A/B FWHM 17.0° Efficiency 85 % Peak intensity 5.430 cd/lm Required components: C12479_MIRELLA-DL</p>		
<p><b>CREE</b> ⇄</p> <p>LED MHB-A/B FWHM 16.0° Efficiency 85 % Peak intensity 7.000 cd/lm Required components: C13333_MIRELLA-CL</p>		

#### PHOTOMETRIC DATA (MEASURED):



LED XHP50  
 FWHM 22.0°  
 Efficiency 86 %  
 Peak intensity 2.800 cd/lm  
 Required components:  
 C13723\_MIRELLA-RZL

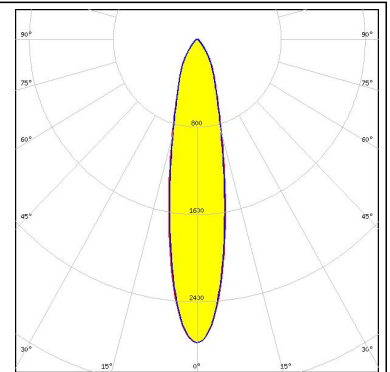

LED XHP50  
 FWHM 13.0°  
 Efficiency 93 %  
 Peak intensity 8.800 cd/lm  
 Required components:

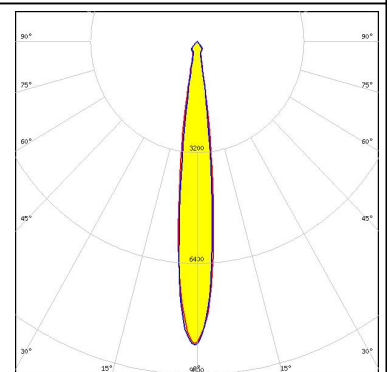

LED XHP50  
 FWHM 16.0°  
 Efficiency 89 %  
 Peak intensity 5.300 cd/lm  
 Required components:  
 C12479\_MIRELLA-DL

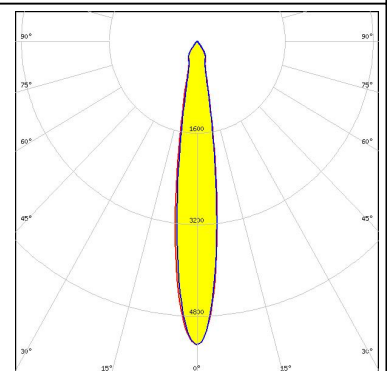

LED XHP50  
 FWHM 14.0°  
 Efficiency 88 %  
 Peak intensity 7.000 cd/lm  
 Required components:  
 C13333\_MIRELLA-CL

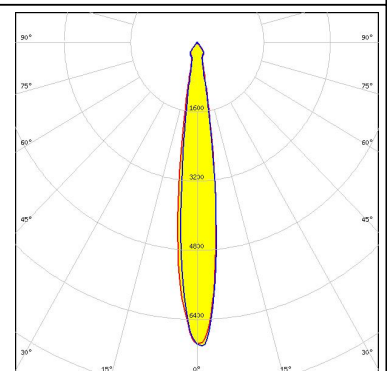

#### PHOTOMETRIC DATA (MEASURED):



LED XM-L  
FWHM 8.7°  
Efficiency 90 %  
Peak intensity 19.340 cd/lm  
Required components:

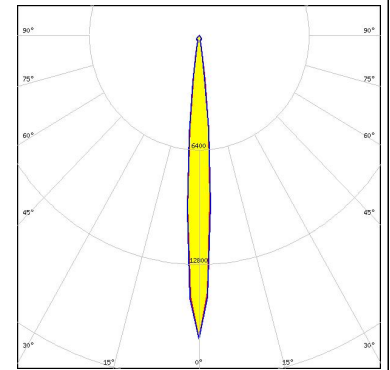
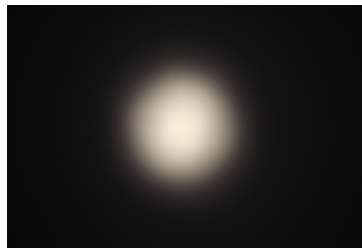

LED XM-L  
FWHM 12.0°  
Efficiency 85 %  
Peak intensity 11.380 cd/lm  
Required components:  
C13333\_MIRELLA-CL



LED XM-L  
FWHM 12.0°  
Efficiency 86 %  
Peak intensity 8.730 cd/lm  
Required components:  
C12479\_MIRELLA-DL



LED XM-L RGB  
FWHM 21.0°  
Efficiency 84 %  
Peak intensity 3.350 cd/lm  
Required components:  
C13723\_MIRELLA-RZL

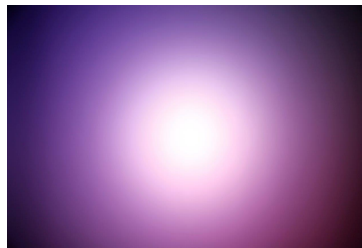

### PHOTOMETRIC DATA (MEASURED):

#### CREE ⇄

LED XM-L2  
FWHM 8.6°  
Efficiency 91 %  
Peak intensity 18.940 cd/lm  
Required components:



#### CREE ⇄

LED XM-L2  
FWHM 12.0°  
Efficiency 86 %  
Peak intensity 8.190 cd/lm  
Required components:  
C12479\_MIRELLA-DL



#### CREE ⇄

LED XP-G  
FWHM 8.1°  
Efficiency 91 %  
Peak intensity 24.980 cd/lm  
Required components:

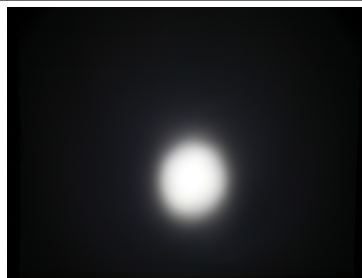

#### CREE ⇄

LED XP-G  
FWHM 11.0°  
Efficiency 86 %  
Peak intensity 14.120 cd/lm  
Required components:  
C13333\_MIRELLA-CL



#### PHOTOMETRIC DATA (MEASURED):

**CREE** 

LED XP-G  
FWHM 11.0°  
Efficiency 86 %  
Peak intensity 10.360 cd/lm  
Required components:  
C12479\_MIRELLA-DL



**CREE** 

LED XP-G2  
FWHM 7.9°  
Efficiency 91 %  
Peak intensity 25.060 cd/lm  
Required components:



**CREE** 

LED XP-G2  
FWHM 11.0°  
Efficiency 87 %  
Peak intensity 10.360 cd/lm  
Required components:  
C12479\_MIRELLA-DL

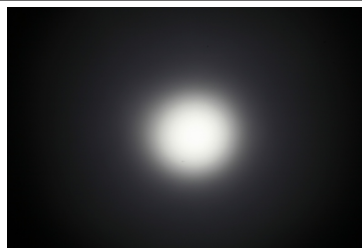

**CREE** 

LED XP-L HI  
FWHM 7.7°  
Efficiency 90 %  
Peak intensity 24.900 cd/lm  
Required components:

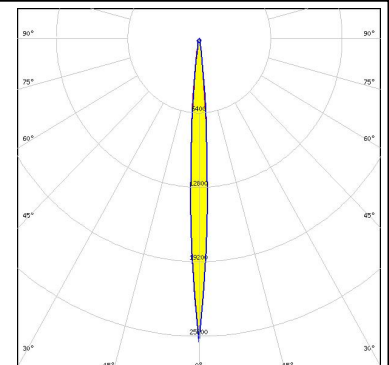
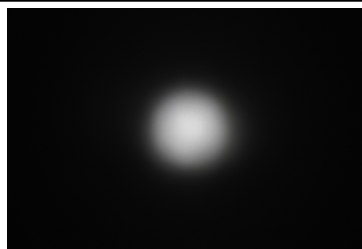

#### PHOTOMETRIC DATA (MEASURED):

#### CREE

LED XT-E  
FWHM 11.0°  
Efficiency 85 %  
Peak intensity 9.910 cd/lm  
Required components:  
C12479\_MIRELLA-DL

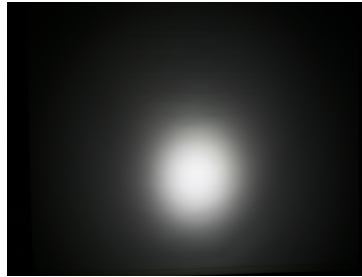

#### CREE

LED XT-E  
FWHM 7.6°  
Efficiency 89 %  
Peak intensity 23.980 cd/lm  
Required components:



#### CREE

LED XT-E  
FWHM 10.0°  
Efficiency 84 %  
Peak intensity 14.100 cd/lm  
Required components:  
C13333\_MIRELLA-CL



#### LUMILEDS

LED LUXEON 5050  
FWHM 11.0°  
Efficiency 93 %  
Peak intensity 11.900 cd/lm  
Required components:

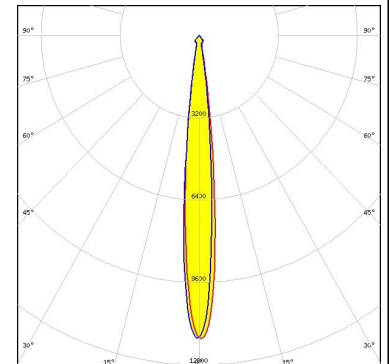



#### PHOTOMETRIC DATA (MEASURED):

##### LUMILEDS

LED LUXEON A  
FWHM 10.0°  
Efficiency 85 %  
Peak intensity 14.520 cd/lm  
Required components:  
C13333\_MIRELLA-CL



##### LUMILEDS

LED LUXEON A  
FWHM 12.0°  
Efficiency 85 %  
Peak intensity 8.890 cd/lm  
Required components:  
C12479\_MIRELLA-DL



##### LUMILEDS

LED LUXEON A  
FWHM 8.9°  
Efficiency 89 %  
Peak intensity 20.540 cd/lm  
Required components:

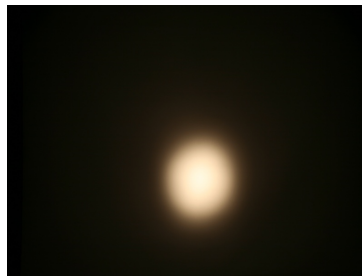

##### LUMILEDS

LED LUXEON C RGBW  
FWHM 22.0°  
Efficiency 81 %  
Peak intensity 3.130 cd/lm  
Required components:  
C13723\_MIRELLA-RZL

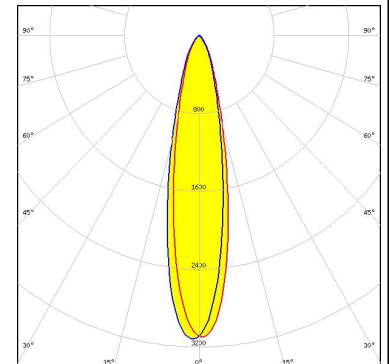
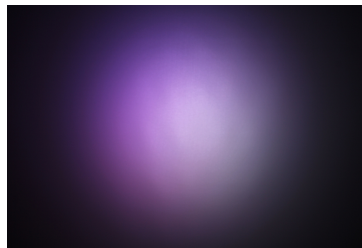

#### PHOTOMETRIC DATA (MEASURED):

##### LUMILEDS

LED LUXEON M/MX  
 FWHM 12.0°  
 Efficiency 91 %  
 Peak intensity 10.310 cd/Im  
 Required components:

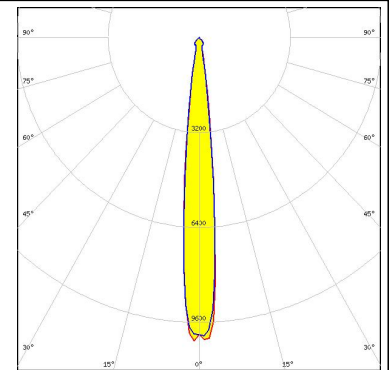

##### LUMILEDS

LED LUXEON M/MX  
 FWHM 15.0°  
 Efficiency 85 %  
 Peak intensity 7.240 cd/Im  
 Required components:  
 C13333\_MIRELLA-CL



##### LUMILEDS

LED LUXEON M/MX  
 FWHM 15.0°  
 Efficiency 86 %  
 Peak intensity 5.880 cd/Im  
 Required components:  
 C12479\_MIRELLA-DL



##### LUMILEDS

LED LUXEON MZ  
 FWHM 8.7°  
 Efficiency 90 %  
 Peak intensity 19.280 cd/Im  
 Required components:

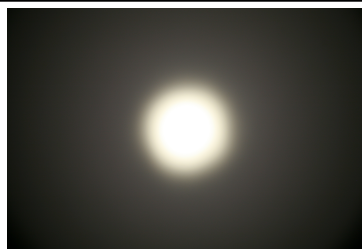

#### PHOTOMETRIC DATA (MEASURED):

##### LUMILEDS

LED LUXEON MZ  
FWHM 11.0°  
Efficiency 85 %  
Peak intensity 9.250 cd/lm  
Required components:  
C12479\_MIRELLA-DL



##### LUMILEDS

LED LUXEON Z RGB  
FWHM 18.0°  
Efficiency 82 %  
Peak intensity 3.400 cd/lm  
Required components:  
C13723\_MIRELLA-RZL

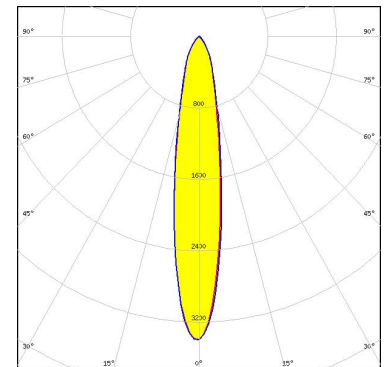
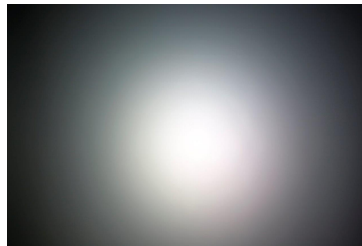

##### NICHIA

LED NS9x383  
FWHM 9.2°  
Efficiency 89 %  
Peak intensity 17.740 cd/lm  
Required components:

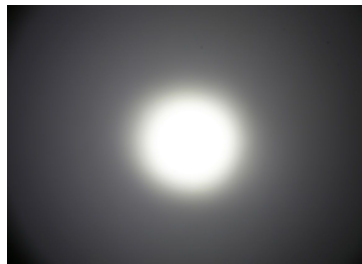

##### NICHIA

LED NS9x383  
FWHM 12.0°  
Efficiency 85 %  
Peak intensity 8.430 cd/lm  
Required components:  
C12479\_MIRELLA-DL



**PHOTOMETRIC DATA (MEASURED):**



LED NV4x144A  
 FWHM 13.0°  
 Efficiency 92 %  
 Peak intensity 9.200 cd/lm  
 Required components:

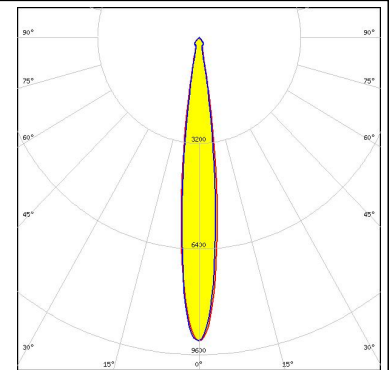

LED Duris S8  
 FWHM 11.0°  
 Efficiency 86 %  
 Peak intensity 11.600 cd/lm  
 Required components:  
 C13333\_MIRELLA-CL



LED Duris S8  
 FWHM 12.0°  
 Efficiency 86 %  
 Peak intensity 8.300 cd/lm  
 Required components:  
 C12479\_MIRELLA-DL

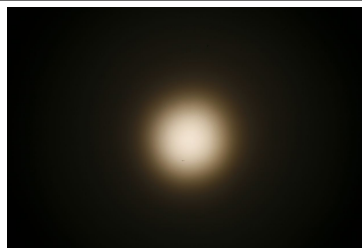

LED Duris S8  
 FWHM 9.7°  
 Efficiency 91 %  
 Peak intensity 16.040 cd/lm  
 Required components:



#### PHOTOMETRIC DATA (MEASURED):

**OSRAM**  
Opto Semiconductors

LED Oslon Square EC  
FWHM 11.0°  
Efficiency 85 %  
Peak intensity 9.700 cd/lm  
Required components:  
C12479\_MIRELLA-DL



**OSRAM**  
Opto Semiconductors

LED Oslon Square EC  
FWHM 8.0°  
Efficiency 90 %  
Peak intensity 23.550 cd/lm  
Required components:



**OSRAM**  
Opto Semiconductors

LED Oslon Square EC  
FWHM 9.4°  
Efficiency 85 %  
Peak intensity 15.380 cd/lm  
Required components:  
C13333\_MIRELLA-CL



**OSRAM**  
Opto Semiconductors

LED Ostar-SMT RGB  
FWHM 19.0°  
Efficiency 85 %  
Peak intensity 3.710 cd/lm  
Required components:  
C13723\_MIRELLA-RZL

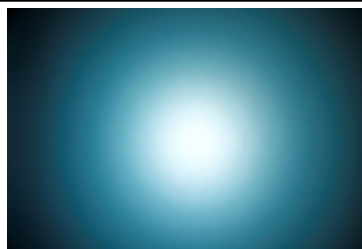

#### PHOTOMETRIC DATA (MEASURED):

### SAMSUNG

LED LH508A  
 FWHM 12.0°  
 Efficiency 90 %  
 Peak intensity 10.500 cd/lm  
 Required components:

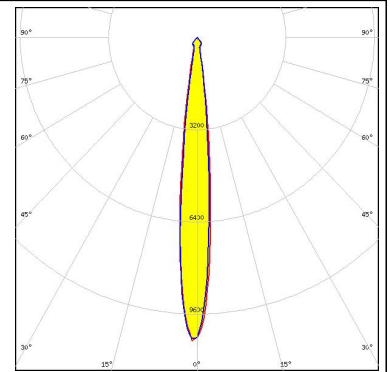
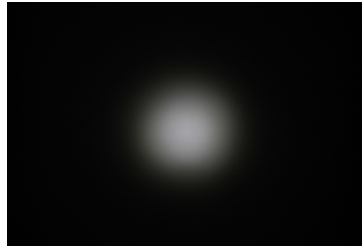

SEOUL SEMICONDUCTOR  
 LED F50360 (RGB)  
 FWHM 21.0°  
 Efficiency 84 %  
 Peak intensity 3.300 cd/lm  
 Required components:  
 C13723\_MIRELLA-RZL

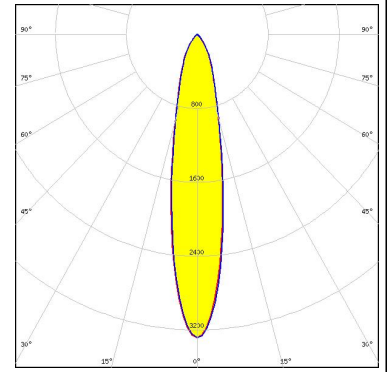

SEOUL SEMICONDUCTOR  
 LED F50360 (RGB)  
 FWHM 19.0°  
 Efficiency 86 %  
 Peak intensity 3.750 cd/lm  
 Required components:  
 C13723\_MIRELLA-RZL



#### PHOTOMETRIC DATA (SIMULATED):



LED XHP35 HD  
 FWHM 11.0°  
 Efficiency 92 %  
 Peak intensity 11.800 cd/lm  
 Required components:

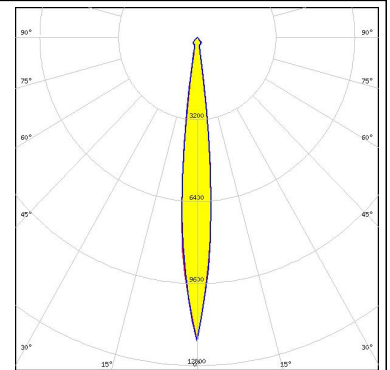

LED LUXEON 5258  
 FWHM 9.0°  
 Efficiency 91 %  
 Peak intensity 17.000 cd/lm  
 Required components:

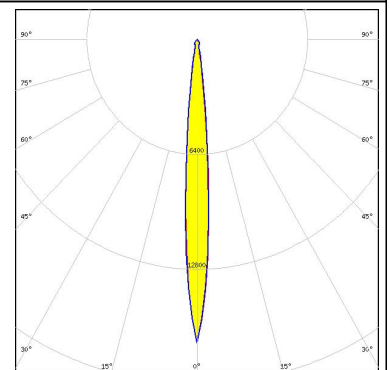

LED OSCONIQ P 7070  
 FWHM 11.0°  
 Efficiency 87 %  
 Peak intensity 10.410 cd/lm  
 Required components:  
 C13333\_MIRELLA-CL

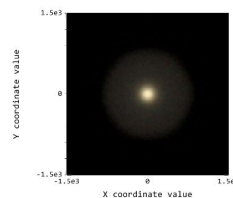

Detector Image: Illuminance  
 OSRAM\_MIRELLA-50-S-PIN-CL-30000\_PSR-200 Configuration: 1 of 2

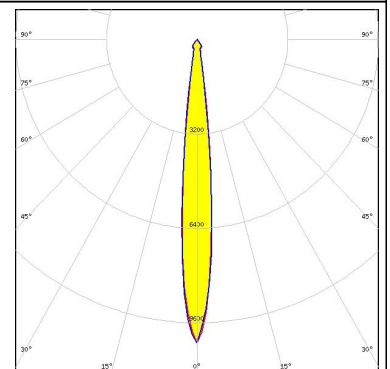

LED OSCONIQ P 7070  
 FWHM 10.0°  
 Efficiency 92 %  
 Peak intensity 11.600 cd/lm  
 Required components:

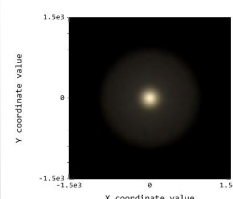

Detector Image: Illuminance  
 OSRAM\_MIRELLA-50-S-PIN-CL-30000\_PSR-200 Configuration: 2 of 2

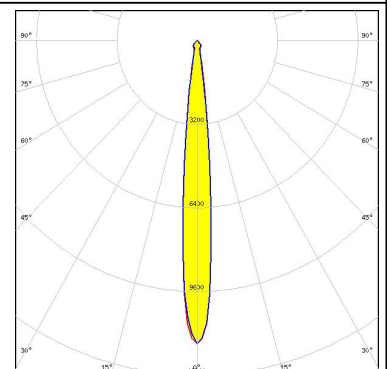

#### PHOTOMETRIC DATA (SIMULATED):

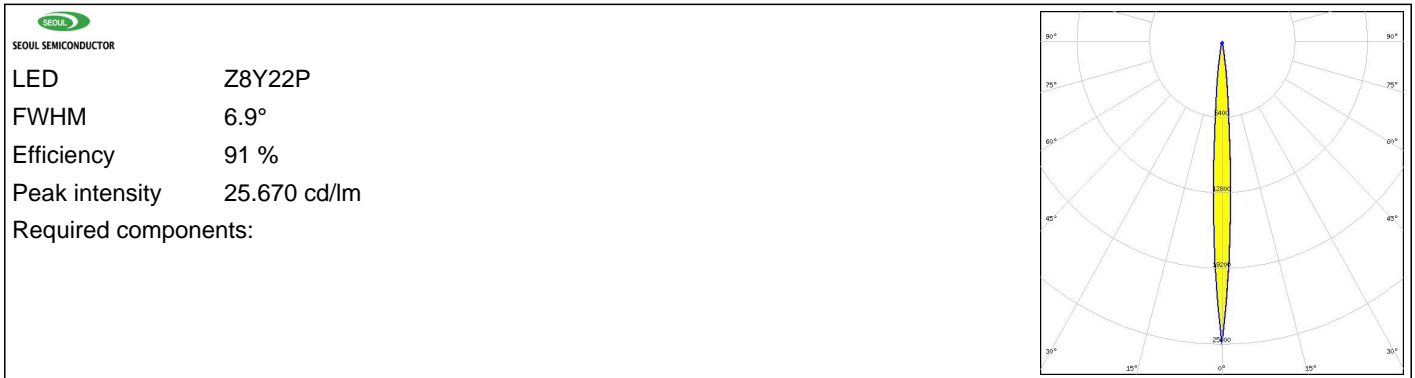



#### GENERAL INFORMATION:

NOTE: The typical beam angle will be changed by different color, chip size and chip position tolerance. The typical total beam angle is the full angle measured where the luminous intensity is half of the peak value.

#### MATERIALS:

As part of our continuous research and improvement processes, and to ensure the best possible quality and availability of our products, LEDiL reserves the right to change material grades without notice.

#### PRODUCT DATA USER AGREEMENT AND DISCLAIMER:

The measured data in the provided downloadable LEDiL Product Datasheets and Mechanical 2D-Drawings is rounded and provided as reference for planning. LEDiL Oy's optical specifications have been verified by conducting performance testing of the products in accordance with the company's quality system. The reported data are averaged results of multiple measurements with typical variation. LEDiL Oy reserves the right to without prior notification make changes and improvements to its products.

LEDiL Oy assumes neither warranty, nor guarantee nor any other liability of any kind for the contents and correctness of the provided data. The provided data has been generated with highest diligence but the provided data may in reality not represent the complete possible variation range of all intrinsic parameters. Therefore, in certain cases a deviation from the provided data could occur.

LEDiL Oy reserves the right to undertake technical changes of its products without further notification which could lead to changes in the provided data. LEDiL Oy assumes no liability of any kind for the possible deviation from any provided data or any other damage resulting from the usage of the provided data.

The user agrees to this disclaimer and user agreement with the download or usage of the provided files.

#### LEDiL Oy

Joensuunkatu 13  
FI-24240 SALO  
Finland

#### LEDiL Inc.

228 West Page Street  
Suite D  
Sycamore IL 60178  
USA

#### Local sales and technical support

[www.ledil.com/  
where\\_to\\_buy](http://www.ledil.com/where_to_buy)

#### Shipping locations

Salo, Finland  
Hong Kong, China

#### Distribution Partners

[www.ledil.com/  
where\\_to\\_buy](http://www.ledil.com/where_to_buy)