

Cylindrical High-Intensity LED (5 mm)

OVLLx8C7

- Wide viewing angle
- High-brightness indicator
- Industry standard lead spacing
- Unique lens shape for flexible applications

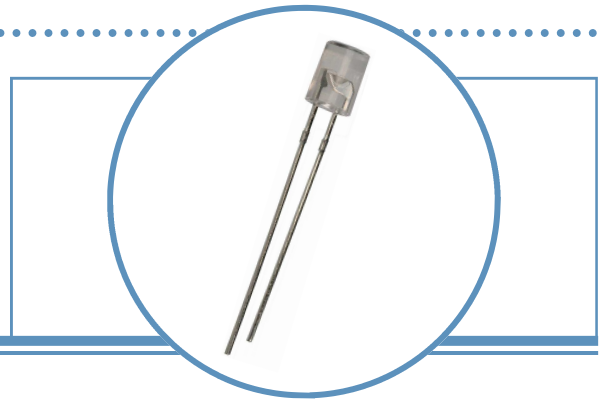

The **OVLLx8C7** series is designed for superior performance in signage and lighting applications that require wide-angle uniform light output. These devices combine a high-intensity LED with a unique flat-topped T-1¼ package to provide both high brightness and a wide spatial radiation pattern.

Applications

- Channel letter and other signage backlighting
- Decorative architectural indoor and outdoor lighting accents
- Industrial and consumer indicators

Part Number	Material	Emitted Color	Intensity Typ. mcd	Lens Color
OVLLB8C7	InGaN	Blue	440	Clear
OVLLG8C7	InGaN	Green	2400	Clear
OVLLR8C7	AllnGaP	Red	900	Clear
OVLLY8C7	AllnGaP	Yellow	980	Clear

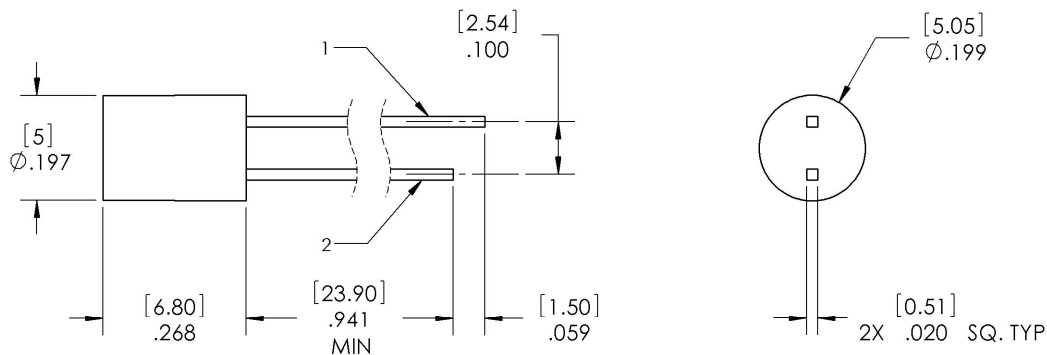

1 ANODE 2 CATHODE DIMENSIONS ARE IN INCHES AND [MILLIMETERS].
TOLERANCES ARE .005 [.12] UNLESS OTHERWISE SPECIFIED.

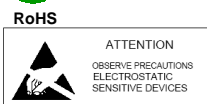

DO NOT LOOK DIRECTLY AT LED WITH UNSHIELDED EYES OR DAMAGE TO RETINA MAY OCCUR.

OPTEK reserves the right to make changes at any time in order to improve design and to supply the best product possible.

Cylindrical High-Intensity LED

OVLLx8C7



Absolute Maximum Ratings

T_A = 25° C unless otherwise noted

Storage Temperature Range		-40 ~ +100° C
Operating Temperature Range		-40 ~ +100° C
Reverse Voltage		5 V
Continuous Forward Current	Blue, Green	25 mA
	Red, Yellow	50 mA
Peak Forward Current (10% Duty Cycle, 1 KHz)		100 mA
Power Dissipation	Blue, Green	100 mW
	Red, Yellow	120 mW
Lead Soldering Temperature (4 mm from the base of the epoxy bulb) ¹		260° C / 5 seconds
LED Junction Temperature		125° C
Electrostatic Discharge Classification (JEDEC-JESD22-A114F)		Class 1C
Current Linearity vs. Ambient Temperature	Blue, Green	-0.29 mA/° C
	Red, Yellow	-0.72 mA/° C

Electrical Characteristics

T_A = 25° C unless otherwise noted

SYMBOL	PARAMETER	COLOR	MIN	TYP	MAX	UNITS	CONDITIONS
I _v	Luminous Intensity	Blue	295	440	----	mcd	I _F = 20 mA
		Green	1135	2400	----		
		Red	580	900	----		
		Yellow	580	980	----		
V _F	Forward Voltage	Blue, Green	----	3.2	4.0	V	I _F = 20 mA
		Red, Yellow	----	2.0	2.4		
I _R	Reverse Current	Blue, Green	----	----	10	μA	V _R = 5 V
		Red, Yellow					
λ _D	Dominant Wavelength	Blue	460	470	475	nm	I _F = 20 mA
		Green	519	525	531		
		Red	620	623	630		
		Yellow	585	589	595		
2Θ _{1/2} H-H	50% Power Angle	Blue, Green	----	85	----	deg	I _F = 20 mA
		Red, Yellow	----	100	----		

OPTEK reserves the right to make changes at any time in order to improve design and to supply the best product possible.

Cylindrical High-Intensity LED

OVLLx8C7



Standard Bins

LEDs are sorted to luminous intensity (I_V), forward voltage (V_F) and dominant wavelength (nm) bins listed below. Each bag consists of a single intensity bin, single voltage bin and a single color bin. Orders are filled using all intensity and color bins listed in the following tables. Optek will not accept orders for single intensity bins, single voltage bins or single color bins.

Luminous Intensity (I_V) @ 20mA

BLUE: OVLLB8C7		
IV Code	Min (mcd)	Max (mcd)
0N	295	415
0P	415	580
0Q	580	810
GREEN: OVLLG8C7		
IV Code	Min (mcd)	Max (mcd)
0S	1135	1590
0T	1590	2225
0U	2225	3115
0V	3115	4360

Forward Voltage (V_F)

BLUE: OVLLB8C7 & GREEN: OVLLG8C7		
VF Code	Min	Max
A	2.6	2.8
B	2.8	3.0
C	3.0	3.2
D	3.2	3.4
E	3.4	3.6
F	3.6	3.8
G	3.8	4.0

Dominant Wavelength (nm)

BLUE: OVLLB8C7		
Color Code	Min (nm)	Max (nm)
BC	460	465
BD	465	470
BE	470	475
GREEN: OVLLG8C7		
Color Code	Min (nm)	Max (nm)
FB	519	523
FC	523	527
FD	527	531

Luminous Intensity (I_V) @ 20mA

RED: OVLLR8C7		
IV Code	Min (mcd)	Max (mcd)
0Q	580	810
0R	810	1135
0S	1135	1590
YELLOW: OVLLY8C7		
IV Code	Min (mcd)	Max (mcd)
0Q	580	810
0R	810	1135
0S	1135	1590

Forward Voltage (V_F)

RED: OVLLR8C7 & YELLOW: OVLLY8C7		
VF Code	Min	Max
A	1.8	2.0
B	2.0	2.2
C	2.2	2.4

Dominant Wavelength (nm)

RED: OVLLR8C7		
Color Code	Min (nm)	Max (nm)
RA	620	625
RB	625	630
YELLOW: OVLLY8C7		
Color Code	Min (nm)	Max (nm)
YC	585	587
YD	587	589
YE	589	591
YF	591	593
YG	593	595

OPTEK reserves the right to make changes at any time in order to improve design and to supply the best product possible.

Typical Electro-Optical Characteristics Curves (BLUE)

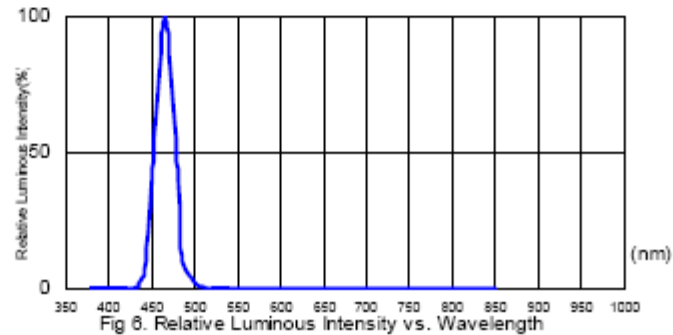
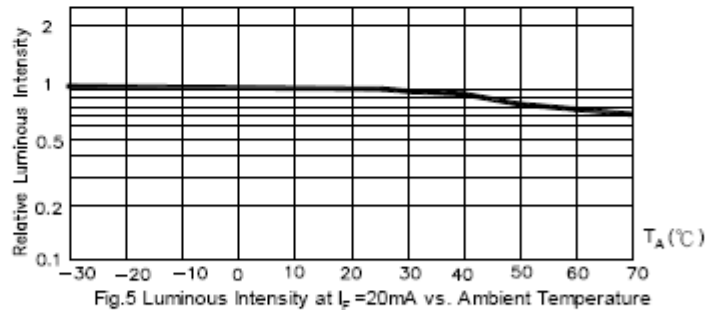
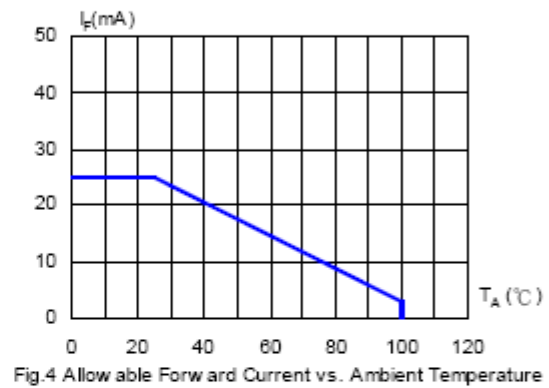
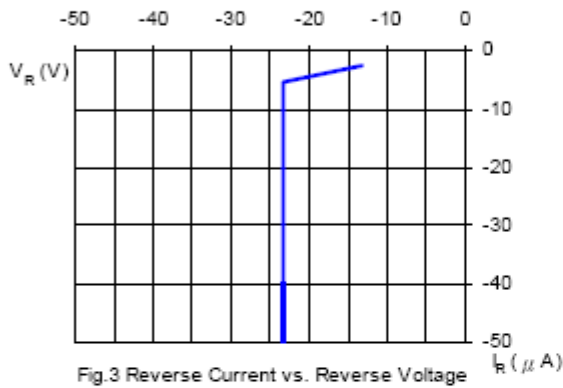
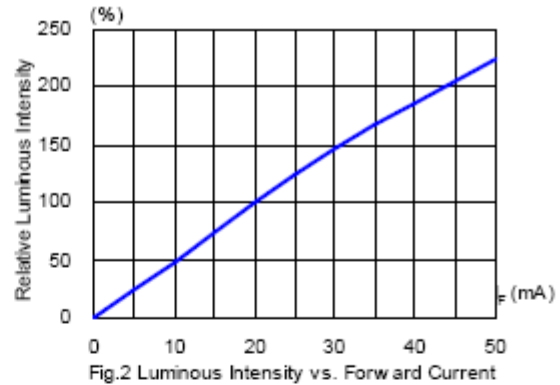
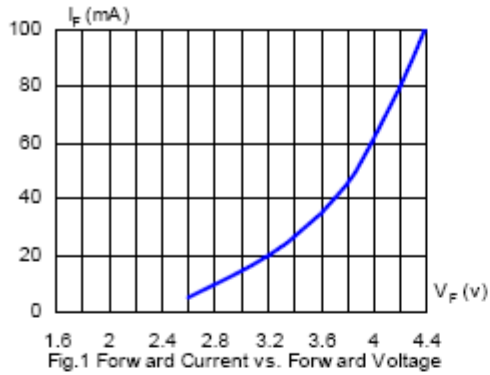

OPTeK reserves the right to make changes at any time in order to improve design and to supply the best product possible.

Typical Electro-Optical Characteristics Curves (GREEN)



Fig.1 Forward Current vs. Forward Voltage

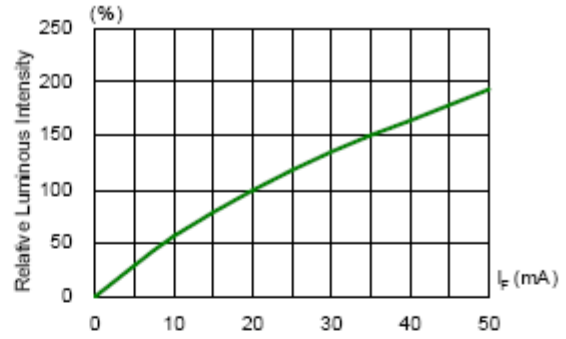

Fig.2 Luminous Intensity vs. Forward Current

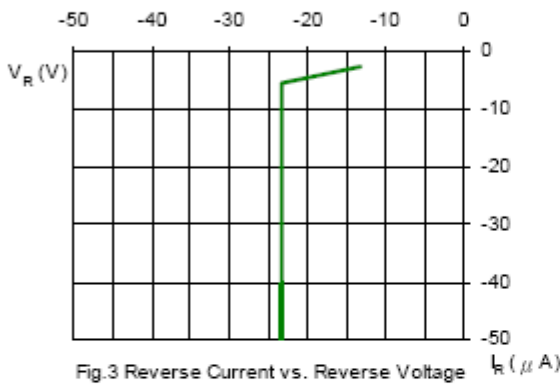

Fig.3 Reverse Current vs. Reverse Voltage

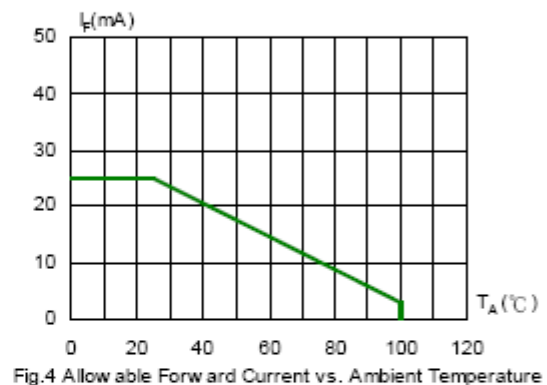

Fig.4 Allowable Forward Current vs. Ambient Temperature

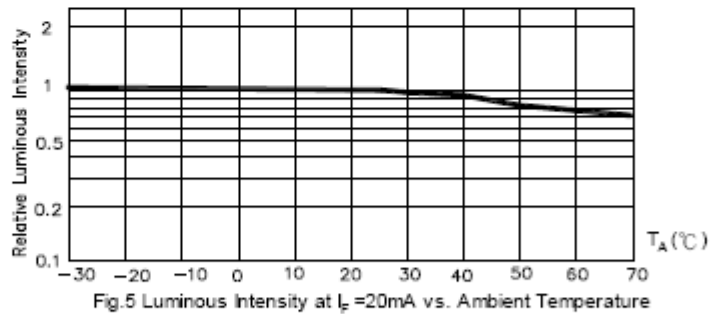

Fig.5 Luminous Intensity at $I_F=20mA$ vs. Ambient Temperature

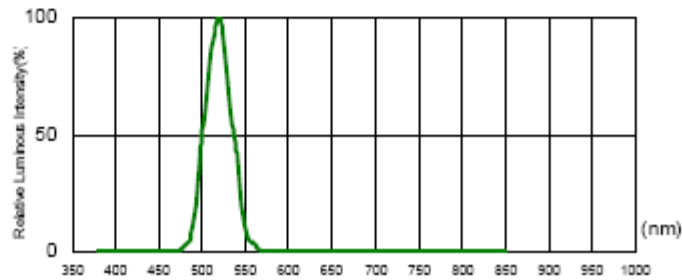

Fig.6. Relative Luminous Intensity vs. Wavelength

OPTEK reserves the right to make changes at any time in order to improve design and to supply the best product possible.

Typical Electro-Optical Characteristics Curves (RED)

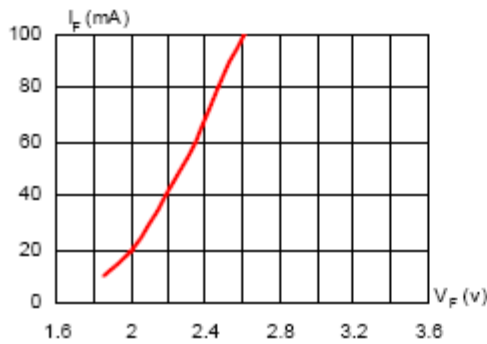

Fig.1 Forward Current vs. Forward Voltage

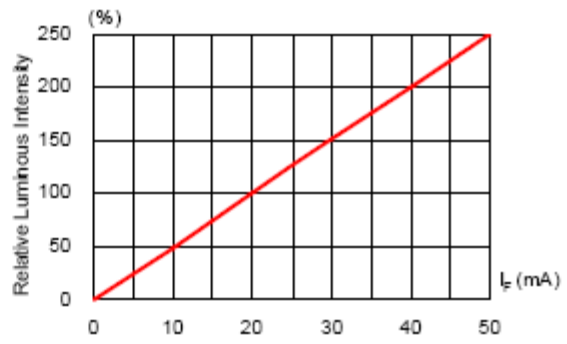

Fig.2 Luminous Intensity vs. Forward Current

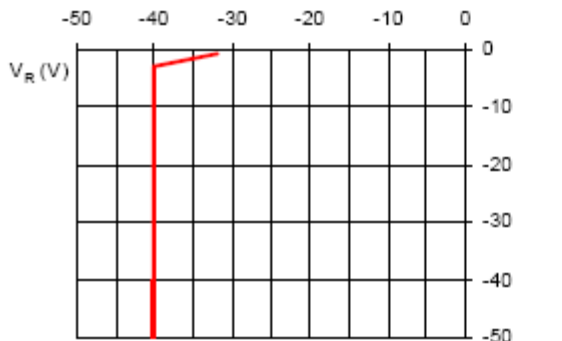

Fig.3 Reverse Current vs. Reverse Voltage

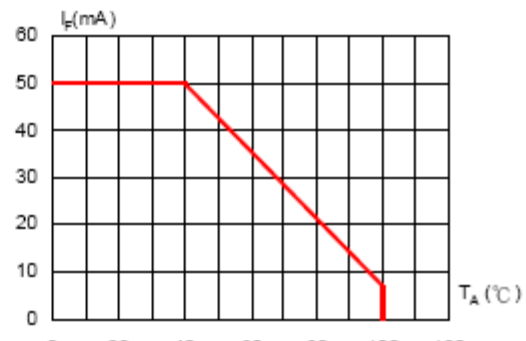

Fig.4 Allowable Forward Current vs. Ambient Temperature

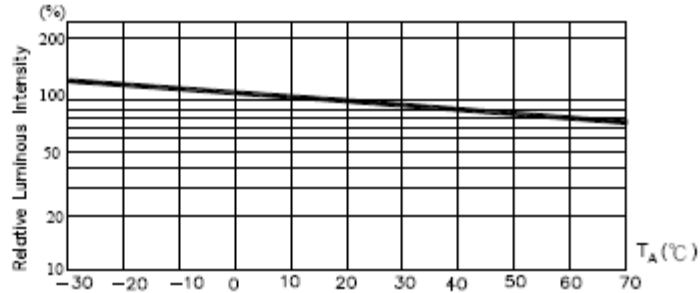

Fig.5 Luminous Intensity at $I_F=20mA$ vs. Ambient Temperature

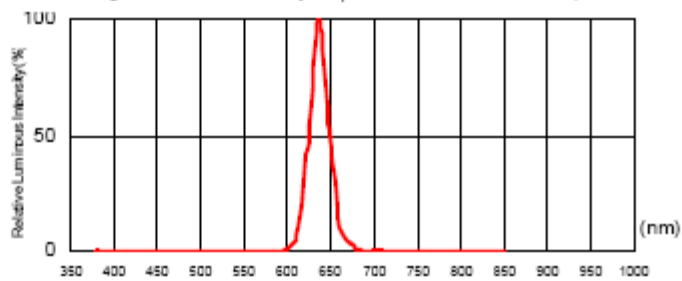

Fig.6. Relative Luminous Intensity vs. Wavelength

OPTeK reserves the right to make changes at any time in order to improve design and to supply the best product possible.

Typical Electro-Optical Characteristics Curves (YELLOW)

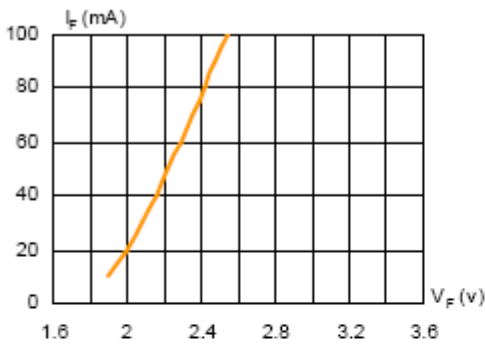

Fig.1 Forward Current vs. Forward Voltage

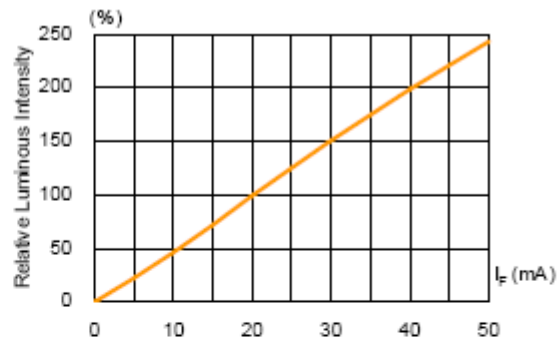

Fig.2 Luminous Intensity vs. Forward Current

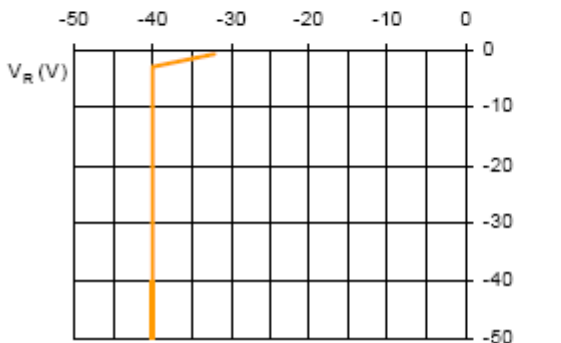

Fig.3 Reverse Current vs. Reverse Voltage

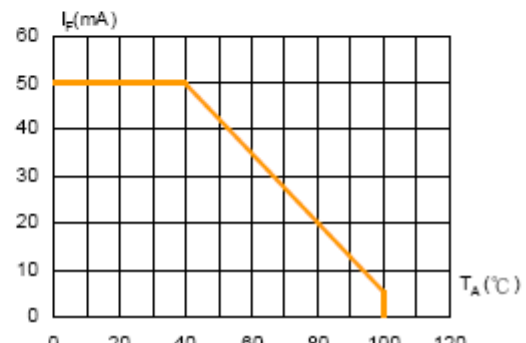

Fig.4 Allowable Forward Current vs. Ambient Temperature

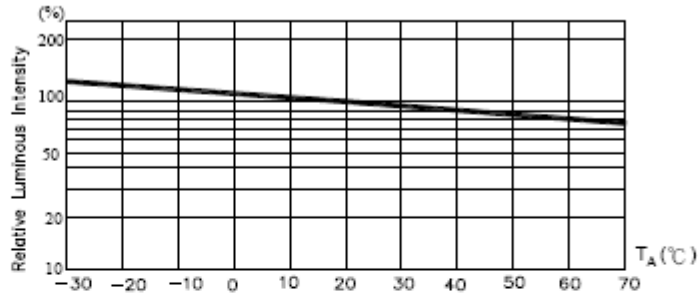

Fig.5 Luminous Intensity at $I_F=20mA$ vs. Ambient Temperature

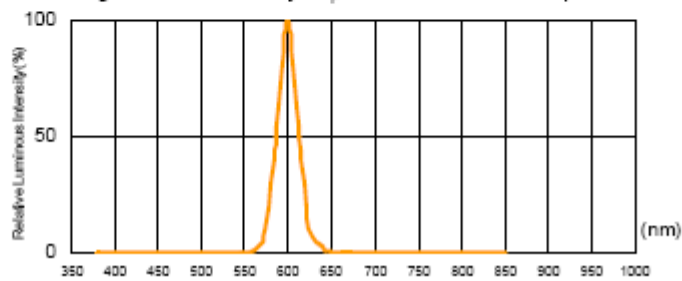
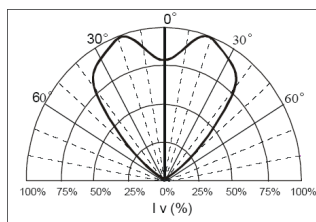

Fig.6 Relative Luminous Intensity vs. Wavelength

OPTEK reserves the right to make changes at any time in order to improve design and to supply the best product possible.

Beam Pattern

BLUE and GREEN



RED and YELLOW

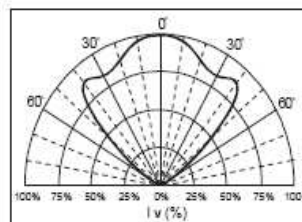

Packaging: 500 pcs per bulk bag with desiccant

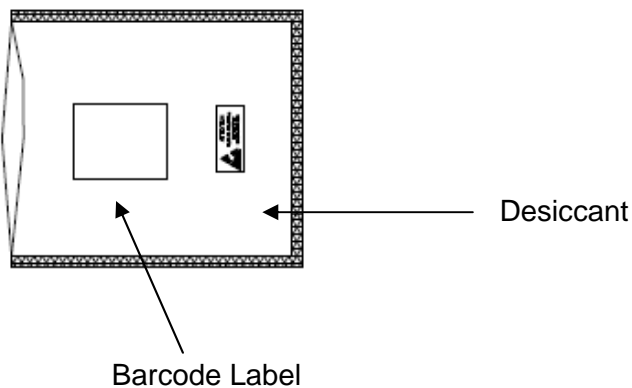

OPTEK reserves the right to make changes at any time in order to improve design and to supply the best product possible.

Reliability Test

LED lamps are checked by reliability tests based on MIL standards.

1. Test Conditions, Acceptable Criteria & Results:

Classification	Test Item	Standard Test Method	Test Conditions	Duration	Unit	Acc / Rej Criteria	Result
Life Test	Operation Life Test (OLT)	MIL-STD-750D Method 1026.3	$T_A=25^{\circ}\text{C}$, $I_F=30\text{mA}$ *	1000 Hrs	100	0 / 1	Pass
Environment Test	High Temperature Storage (HTS)	MIL-STD-750D Method 1032.1	$T_A=100^{\circ}\text{C}$	1000 Hrs	100	0 / 1	Pass
	Low Temperature Storage (LTS)	MIL-STD-750D Method 1032.1	$T_A=-40^{\circ}\text{C}$	1000 Hrs	100	0 / 1	Pass
	Temp. & Humidity with Bias (THB)	MIL-STD-750D Method 103B	$T_A=85^{\circ}\text{C}$, $\text{Rh}=85\%$ $I_F=20\text{mA}$ **	500 Hrs	100	0 / 1	Pass
	Thermal Shock Test (TST)	MIL-STD-750D Method 1056.1	$0^{\circ}\text{C} \sim 100^{\circ}\text{C}$ 2min 2min	100 cycles	100	0 / 1	Pass
	Temperature Cycling Test (TCT)	MIL-STD-750D Method 1051.5	$-40^{\circ}\text{C} \sim 25^{\circ}\text{C} \sim 100^{\circ}\text{C} \sim 25^{\circ}\text{C}$ 30min 5min 30min 5min	100 cycles	100	0 / 1	Pass
Mechanical Test	Solderability	MIL-STD-750D Method 2026.4	$235\pm 5^{\circ}\text{C}$, 5 sec.	1 time	20	0 / 1	Pass
	Resistance to Soldering Heat	MIL-STD-750D Method 2031.1	$260\pm 5^{\circ}\text{C}$, 5 sec.	1 time	20	0 / 1	Pass
	Lead Integrity	MIL-STD-750D Method 2036.3	Load 2.5N (0.25kgf) $0^{\circ} \sim 90^{\circ} \sim 0^{\circ}$, bend	3 times	20	0 / 1	Pass

Remark : (*) $I_F=30\text{mA}$ for AlInGaP chip ; $I_F=20\text{mA}$ for InGaN chip

(**) $I_F=20\text{mA}$ for AlInGaP chip ; $I_F=10\text{mA}$ for InGaN chip

2. Failure Criteria ($T_A=25^{\circ}\text{C}$):

Test Item	Symbol	Test Conditions	Criteria for Judgment	
			Min.	Max.
Luminous Intensity	I_V	$I_F=20\text{mA}$	$\text{LSL} \times 0.7$ **	
Forward Voltage	V_F	$I_F=20\text{mA}$		$\text{USL} \times 1.1$ *

(*) USL : Upper Standard Level , (**) LSL : Lower Standard Level

OPTEK reserves the right to make changes at any time in order to improve design and to supply the best product possible.