



**User Manual**

# SOM-7567

**ADVANTECH**

*Enabling an Intelligent Planet*

---

## Copyright

The documentation and the software included with this product are copyrighted 2014 by Advantech Co., Ltd. All rights are reserved. Advantech Co., Ltd. reserves the right to make improvements in the products described in this manual at any time without notice. No part of this manual may be reproduced, copied, translated or transmitted in any form or by any means without the prior written permission of Advantech Co., Ltd. Information provided in this manual is intended to be accurate and reliable. However, Advantech Co., Ltd. assumes no responsibility for its use, nor for any infringements of the rights of third parties, which may result from its use.

## Acknowledgements

Intel® and Pentium® are trademarks of Intel Corporation.

Microsoft Windows and MS-DOS are registered trademarks of Microsoft Corp.

All other product names or trademarks are properties of their respective owners.

## Product Warranty (2 years)

Advantech warrants to you, the original purchaser, that each of its products will be free from defects in materials and workmanship for two years from the date of purchase.

This warranty does not apply to any products which have been repaired or altered by persons other than repair personnel authorized by Advantech, or which have been subject to misuse, abuse, accident or improper installation. Advantech assumes no liability under the terms of this warranty as a consequence of such events.

Because of Advantech's high quality-control standards and rigorous testing, most of our customers never need to use our repair service. If an Advantech product is defective, it will be repaired or replaced at no charge during the warranty period. For out-of-warranty repairs, you will be billed according to the cost of replacement materials, service time and freight. Please consult your dealer for more details.

If you think you have a defective product, follow these steps:

1. Collect all the information about the problem encountered. (For example, CPU speed, Advantech products used, other hardware and software used, etc.) Note anything abnormal and list any onscreen messages you get when the problem occurs.
2. Call your dealer and describe the problem. Please have your manual, product, and any helpful information readily available.
3. If your product is diagnosed as defective, obtain an RMA (return merchandise authorization) number from your dealer. This allows us to process your return more quickly.
4. Carefully pack the defective product, a fully-completed Repair and Replacement Order Card and a photocopy proof of purchase date (such as your sales receipt) in a shippable container. A product returned without proof of the purchase date is not eligible for warranty service.
5. Write the RMA number visibly on the outside of the package and ship it prepaid to your dealer.

# Declaration of Conformity

## CE

This product has passed the CE test for environmental specifications. Test conditions for passing included the equipment being operated within an industrial enclosure. In order to protect the product from being damaged by ESD (Electrostatic Discharge) and EMI leakage, we strongly recommend the use of CE-compliant industrial enclosure products.

## FCC Class B

Note: This equipment has been tested and found to comply with the limits for a Class B digital device, pursuant to part 15 of the FCC Rules. These limits are designed to provide reasonable protection against harmful interference in a residential installation. This equipment generates, uses and can radiate radio frequency energy and, if not installed and used in accordance with the instructions, may cause harmful interference to radio communications. However, there is no guarantee that interference will not occur in a particular installation. If this equipment does cause harmful interference to radio or television reception, which can be determined by turning the equipment off and on, the user is encouraged to try to correct the interference by one or more of the following measures:

- Reorient or relocate the receiving antenna.
- Increase the separation between the equipment and receiver.
- Connect the equipment into an outlet on a circuit different from that to which the receiver is connected.
- Consult the dealer or an experienced radio/TV technician for help.

## FM

This equipment has passed the FM certification. According to the National Fire Protection Association, work sites are classified into different classes, divisions and groups, based on hazard considerations. This equipment is compliant with the specifications of Class I, Division 2, Groups A, B, C and D indoor hazards.

# Technical Support and Assistance

1. Visit the Advantech website at <http://support.advantech.com> where you can find the latest information about the product.
2. Contact your distributor, sales representative, or Advantech's customer service center for technical support if you need additional assistance. Please have the following information ready before you call:
  - Product name and serial number
  - Description of your peripheral attachments
  - Description of your software (operating system, version, application software, etc.)
  - A complete description of the problem
  - The exact wording of any error messages

---

## Warnings, Cautions and Notes

**Warning!** Warnings indicate conditions, which if not observed, can cause personal injury!



**Caution!** Cautions are included to help you avoid damaging hardware or losing data. e.g.



*There is a danger of a new battery exploding if it is incorrectly installed. Do not attempt to recharge, force open, or heat the battery. Replace the battery only with the same or equivalent type recommended by the manufacturer. Discard used batteries according to the manufacturer's instructions.*

**Note!** Notes provide optional additional information.



## Document Feedback

To assist us in making improvements to this manual, we would welcome comments and constructive criticism. Please send all such - in writing to: [support@advan-tech.com](mailto:support@advan-tech.com)

## Packing List

Before setting up the system, check that the items listed below are included and in good condition. If any item does not accord with the table, please contact your dealer immediately.

- SOM-7567 CPU module
- 1 x Heat spreader (1960064246N001)

## Safety Instructions

1. Read these safety instructions carefully.
2. Keep this User Manual for later reference.
3. Disconnect this equipment from any AC outlet before cleaning. Use a damp cloth. Do not use liquid or spray detergents for cleaning.
4. For plug-in equipment, the power outlet socket must be located near the equipment and must be easily accessible.
5. Keep this equipment away from humidity.
6. Put this equipment on a reliable surface during installation. Dropping it or letting it fall may cause damage.
7. The openings on the enclosure are for air convection. Protect the equipment from overheating. **DO NOT COVER THE OPENINGS.**
8. Make sure the voltage of the power source is correct before connecting the equipment to the power outlet.

9. Position the power cord so that people cannot step on it. Do not place anything over the power cord.
10. All cautions and warnings on the equipment should be noted.
11. If the equipment is not used for a long time, disconnect it from the power source to avoid damage by transient overvoltage.
12. Never pour any liquid into an opening. This may cause fire or electrical shock.
13. Never open the equipment. For safety reasons, the equipment should be opened only by qualified service personnel.
14. If one of the following situations arises, get the equipment checked by service personnel:
  - The power cord or plug is damaged.
  - Liquid has penetrated into the equipment.
  - The equipment has been exposed to moisture.
  - The equipment does not work well, or you cannot get it to work according to the user's manual.
  - The equipment has been dropped and damaged.
  - The equipment has obvious signs of breakage.
15. DO NOT LEAVE THIS EQUIPMENT IN AN ENVIRONMENT WHERE THE STORAGE TEMPERATURE MAY GO BELOW  $-20^{\circ}\text{C}$  ( $-4^{\circ}\text{F}$ ) OR ABOVE  $60^{\circ}\text{C}$  ( $140^{\circ}\text{F}$ ). THIS COULD DAMAGE THE EQUIPMENT. THE EQUIPMENT SHOULD BE IN A CONTROLLED ENVIRONMENT.
16. CAUTION: DANGER OF EXPLOSION IF BATTERY IS INCORRECTLY REPLACED. REPLACE ONLY WITH THE SAME OR EQUIVALENT TYPE RECOMMENDED BY THE MANUFACTURER, DISCARD USED BATTERIES ACCORDING TO THE MANUFACTURER'S INSTRUCTIONS.

The sound pressure level at the operator's position according to IEC 704-1:1982 is no more than 70 dB (A).

DISCLAIMER: This set of instructions is given according to IEC 704-1. Advantech disclaims all responsibility for the accuracy of any statements contained herein.

---

## Safety Precaution - Static Electricity

Follow these simple precautions to protect yourself from harm and the products from damage.

- To avoid electrical shock, always disconnect the power from your PC chassis before you work on it. Don't touch any components on the CPU card or other cards while the PC is on.
- Disconnect power before making any configuration changes. The sudden rush of power as you connect a jumper or install a card may damage sensitive electronic components.

# Contents

<b>Chapter 1</b>	<b>General Information .....</b>	<b>1</b>
1.1	Introduction .....	2
1.2	Specifications .....	2
1.2.1	Board Information .....	2
1.2.2	System Information .....	2
1.2.3	Display .....	2
1.2.4	Expansion Interface .....	3
1.2.5	I/O .....	3
1.2.6	iManager 2.0 .....	3
1.2.7	Mechanical and Environmental Specification .....	3
1.3	Functional Block Diagram .....	4
	Figure 1.1 Functional Block Diagram.....	4
<b>Chapter 2</b>	<b>Mechanical Information .....</b>	<b>5</b>
2.1	Board Information.....	6
	Figure 2.1 Board Chips Identify - Front.....	6
	Figure 2.2 Board Chips Identify - Back .....	7
2.2	Mechanical Drawing.....	7
	Figure 2.3 Board Mechanical Drawing - Front .....	7
	Figure 2.4 Board Mechanical Drawing - Back .....	8
2.3	Assembly Drawing .....	8
	Figure 2.5 Assembly Drawing.....	9
2.4	Main Chip Height.....	10
<b>Chapter 3</b>	<b>BIOS .....</b>	<b>11</b>
3.1	Entering Setup .....	12
	Figure 3.1 Setup Program Initial Screen.....	12
3.2	Main Setup .....	13
	Figure 3.2 Main Setup Screen .....	13
3.3	Advanced BIOS Features Setup .....	14
	Figure 3.3 Advanced BIOS Features Setup Screen .....	14
3.3.1	Trusted Computing .....	15
	Figure 3.4 Trusted Computing Settings .....	15
3.3.2	ACPI Settings.....	16
	Figure 3.5 ACPI Settings .....	16
3.3.3	Intel(R) Smart Connect Technology.....	17
	Figure 3.6 Intel(R) Smart Connect Technology .....	17
3.3.4	W83627DHG Super IO Configuration .....	18
	Figure 3.7 W83627DHG Super IO Configuration .....	18
	Figure 3.8 Serial Port 0 Configuration .....	19
	Figure 3.9 Serial Port 1 Configuration .....	20
	Figure 3.10 Parallel Port Configuration.....	21
3.3.5	iManager Configuration.....	22
	Figure 3.11 iManager Configuration .....	22
	Figure 3.12 Serial Port 2 Configuration .....	23
	Figure 3.13 Serial Port 3 Configuration .....	24
	Figure 3.14 Hardware Monitor .....	25
3.3.6	Serial Port Console Redirection .....	26
	Figure 3.15 Serial Port Console Redirection .....	26
3.3.7	CPU Configuration .....	27
	Figure 3.16 CPU Redirection.....	27

	Figure 3.17 Socket 0 CPU Information .....	28
	Figure 3.18 CPU Thermal Configuration .....	29
3.3.8	PPM Configuration .....	30
	Figure 3.19 PPM Configuration .....	30
3.3.9	IDE Configuration .....	31
	Figure 3.20 IDE Configuration .....	31
3.3.10	Network Stack Configuration .....	32
	Figure 3.21 Network Stack Configuration .....	32
3.3.11	CSM Configuration .....	33
	Figure 3.22 CSM Configuration .....	33
3.3.12	USB Configuration .....	34
	Figure 3.23 USB Configuration .....	34
3.3.13	Security Configuration .....	35
	Figure 3.24 Security Configuration .....	35
3.4	Chipset .....	36
	Figure 3.25 Chipset Setup .....	36
3.4.1	North Bridge .....	37
	Figure 3.26 North Bridge .....	37
	Figure 3.27 Intel IGD Configuration .....	38
	Figure 3.28 Graphics Power Management Control .....	39
	Figure 3.29 LCD Control .....	40
3.4.2	South Bridge .....	41
	Figure 3.30 South Bridge .....	41
	Figure 3.31 Azalia HD Audio .....	42
	Figure 3.32 USB Configuration .....	43
	Figure 3.33 PCI Express Configuration .....	44
3.5	Security .....	45
	Figure 3.34 Security .....	45
3.6	Boot .....	46
	Figure 3.35 Security .....	46
3.7	Save & Exit .....	47
	Figure 3.36 Save & Exit .....	47
3.8	Enable USB 3.0 .....	48
3.9	BIOS/FW Supported Matrix .....	50
3.9.1	Configure BIOS as EFI environment .....	50

## **Chapter 4 S/W Introduction & Installation..... 53**

4.1	S/W Introduction .....	54
4.2	Driver Installation .....	54
	4.2.1 Windows XP / Windows 7 Driver Setup .....	54
	4.2.2 Other OS .....	54
4.3	Advantech iManager .....	54

## **Appendix A Pin Assignment..... 57**

A.1	SOM-7567 Type 10 Pin Assignment .....	58
-----	---------------------------------------	----

## **Appendix B Watchdog Timer..... 61**

B.1	Programming the Watchdog Timer .....	62
-----	--------------------------------------	----

## **Appendix C Programming GPIO..... 63**

C.1	GPIO Register .....	64
-----	---------------------	----



<b>Appendix D</b>	<b>System Assignments .....</b>	<b>65</b>
D.1	System I/O Ports .....	66
	Table D.1: System I/O ports .....	66
D.2	DMA Channel Assignments .....	67
	Table D.2: DMA channel assignments .....	67
D.3	Interrupt Assignments .....	68
	Table D.3: Interrupt assignments .....	68
D.4	1st MB Memory Map .....	69
	Table D.4: 1st MB memory map .....	69



# Chapter 1

## General Information

This chapter gives background information on the SOM-7567 CPU Computer on Module

Sections include:

- Introduction
- Specification
- Functional Block Diagram

## 1.1 Introduction

SOM-7567 is a COM-Express Mini module with Type 10 pin-out that fully complies with the PICMG (PCI Industrial Computer Manufacturers Group) COM.0 R2.1 specification.

The new CPU module uses Intel 4th generation of Atom processors (Bay trail) which are based on 22nm leading-edge low-power SoC, and can provide more than twice CPU performance and five times graphic performance over previous Atom series, but with lower power consumption.

SOM-7567 with COMe Mini 84mm x 55mm small form factor integrates up to 4GB on-board memory and up to 64GB on-board flash storage for a perfect rugged solution. In addition, the upgrade of 3 ports of PCIe Gen 2 and USB 3.0 enable this model to achieve higher speeds for data transition. With wide-range voltage input from 4.75 to 20V, SOM-7567 offers a perfect solution for applications in medical, Industrial automation and portable devices.

## 1.2 Specifications

### 1.2.1 Board Information

- **Pin Definition:** PICMG COM.0 R2.1 Type 10 pin-out definition
- **Form Factor:** PICMG COM.0 R2.1 Mini Module 84 x 55 mm

### 1.2.2 System Information

- **CPU:** 4th Generation Intel Atom Processor

CPU	Core	Base Freq. (Normal)	Base Freq. (Burst)	TDP(W)
E3845	4	1.91GHz	-	10
E3825	2	1.33GHz	-	6
E3815	1	1.46GHz	-	5
J1900	4	2.00GHz	2.42GHz	10
N2930	4	1.86GHz	2.00GHz	7.5

- **Memory:**
  - Up to 4GB on board DDR3L 1333MHz memory for E3845, J1900 & N2930.
  - Up to 4GB on board DDR3L 1066MHz memory for E3825 & E3815.
- **BIOS:** AMI UEFI 64Mbit SPI BIOS
- **Power management:** Supports power saving modes including Normal / Standby / Suspend modes. ACPI 2.0 compliant

### 1.2.3 Display

- **Graphic Core:**
  - Supports DX\*11, OpenGL 3.0 (OGL 3.0), OpenCL 1.2 (OCL 1.2), OpenGLES 2.0 (OGLES 2.0)
  - Full HW acceleration for decode of H.264, MPEG2, MVC, VC-1, VP8, MJPEG
  - Full HW acceleration for encode of H.264, MPEG2, MVC
- **LVDS:** Single channel 18/24-bit, up to 1366 x 768 resolution
- **HDMI/DVI/DP:** Supports 1 port HDMI, DVI, or DP multiplexed.
  - HDMI/DVI up to 1920 x 1080

- Display port up to 2560 x 1600.  
(Please contact Advantech to enable Audio output under HDMI/DVI mode)
- **Dual Display:** Supports LVDS + HDMI/DVI/DP

#### 1.2.4 Expansion Interface

- **PCI Express x1:** 3 Ports (optional 4 PCIe x1 or 1 PCIe x4 while removing Ethernet), compliant to PCIe Gen2 5.0 GT/s
- **Audio Interface:** Intel HD Audio interface
- **LPC Bus**
- **SMBus**
- **I2C Bus:** Up to 400KHz
- **SPI:** Supports SPI BIOS only

#### 1.2.5 I/O

- **Onboard Flash:** Supports on board flash up to 64GB
- **Ethernet:** Intel I210 Gigabit LAN supports 10/100/1000 Mbps Speed
- **SATA:** 1 Ports (optional 2 ports while remove onboard storage), compliant to SATA2.0 3.0 Gb/s
- **USB Interface:** Supports 1 port USB3.0, 4 ports USB 2.0
- **Serial Port:** Supports 2 ports 2-wire serial port
- **Express Card:** 2 ports
- **Panel Control:** Supports panel backlight on/off control, brightness control
- **Thermal Protection:** Supports thermal shutdown or CPU throttling
- **Watchdog Timer:** 65536 level timer interval, from 0~65535 sec, multi-level, multi-option watchdog timer
- **Smart Fan:** 1 port down to carrier board
- **GPIO:** 8 GPIO
- **Hardware Monitor:** Vin, 5VSB, CMOS

#### 1.2.6 iManager 2.0

Refer to section 4.3.

#### 1.2.7 Mechanical and Environmental Specification

- **Dimensions:** 84 x 55 mm (3.3" x 2.17")
- **Power Type and Supply Voltage:**  
ATX: VIN:4.75V~20V and VSB: +4.75V~5.25V  
AT: VIN:4.75V~20V  
CMOS Battery: +3.3V
- **Power Requirement:**  
Test condition: WIN8 64-bit, under 12V and 5VSB input power supply. Test with E3845 CPU, TDP 10W.  
Idle: 3.28W  
Max: 5.62W (Burn-in V6.0 Pro)
- **Temperature Specification:**  
Operating: 0 ~ 60°C (32 ~ 140°F)  
Storage: -40 ~ 85°C (-40 ~ 185°F)
- **Humidity Specification:**  
Operating: 40°C@85% relative humidity, non-condensing  
Storage: 60°C@95%relative humidity, non-condensing

## 1.3 Functional Block Diagram

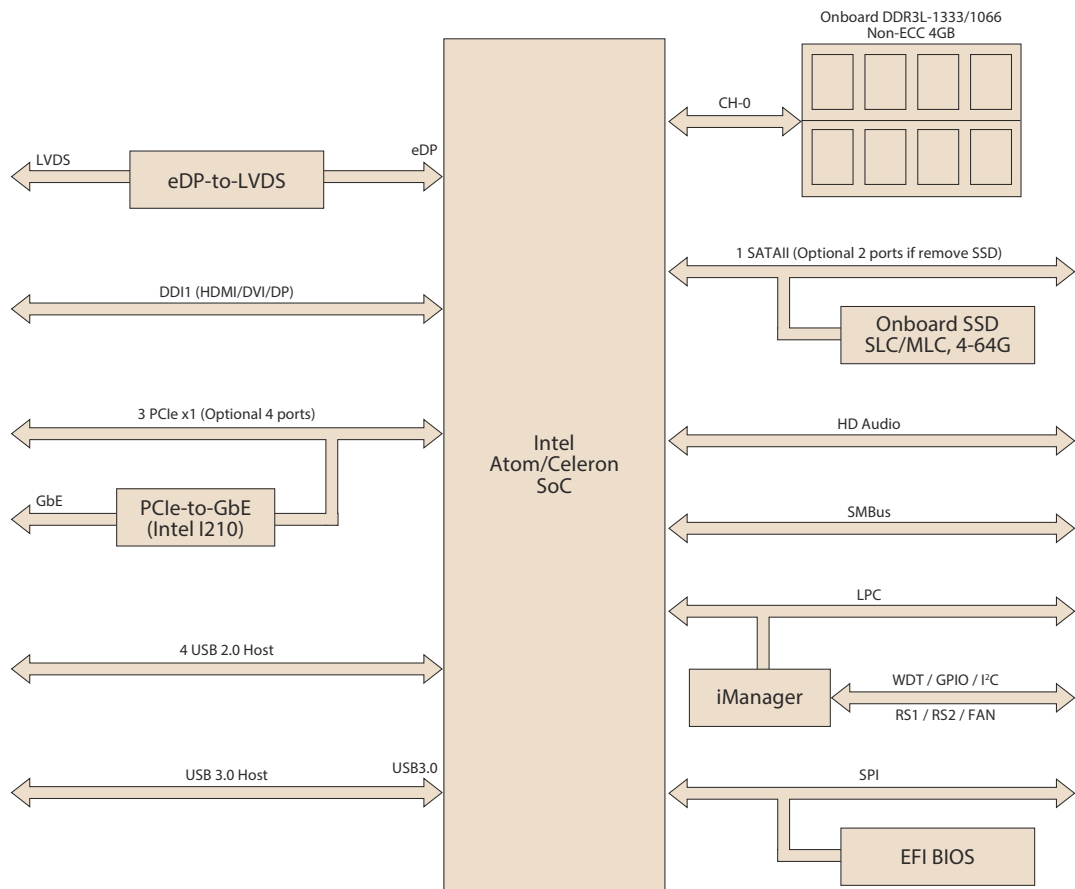

Figure 1.1 Functional Block Diagram

# Chapter 2

## Mechanical Information

This chapter gives mechanical information on the SOM-7567 CPU Computer on Module

Sections include:

- Board Information
- Mechanical Drawing
- Assembly Drawing

## 2.1 Board Information

The figures below show the main chips on SOM-7567 Computer-on-Module. Please be aware on their locations when designing your own carrier board to avoid mechanical and thermal problems.

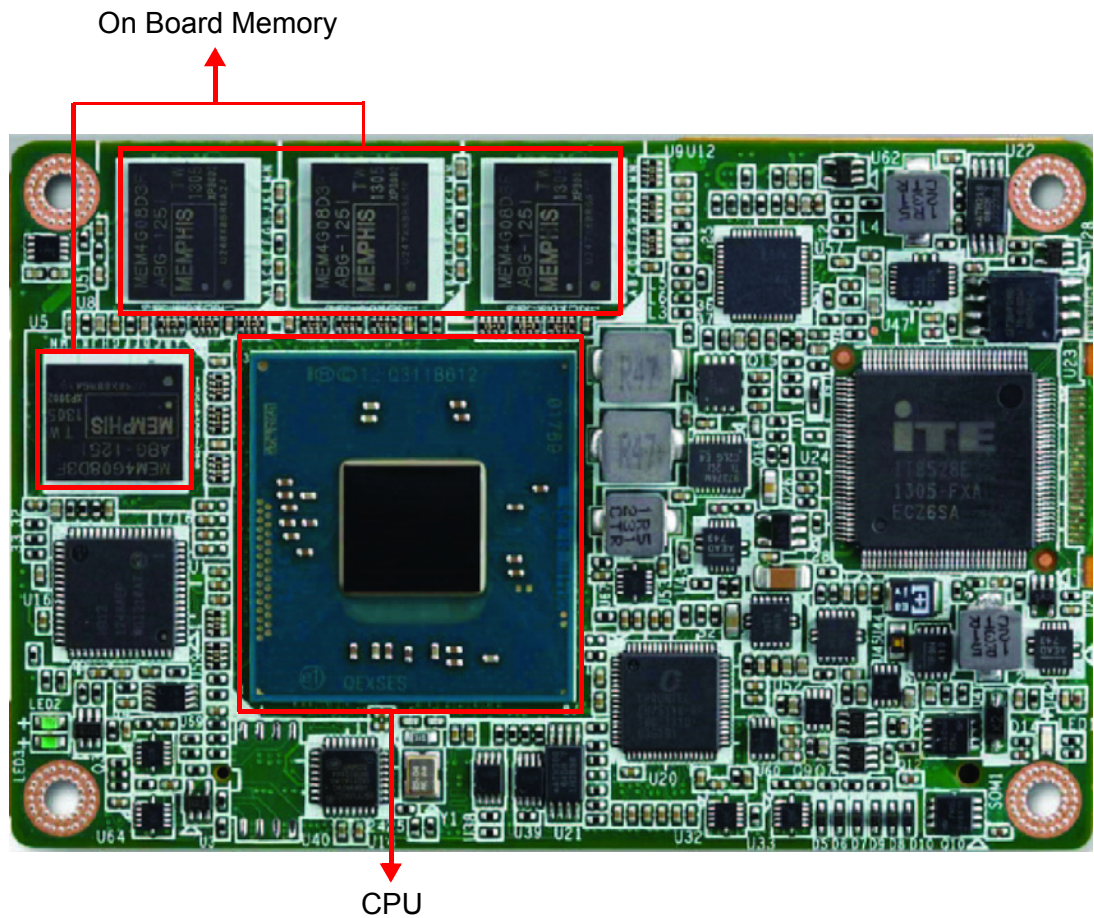
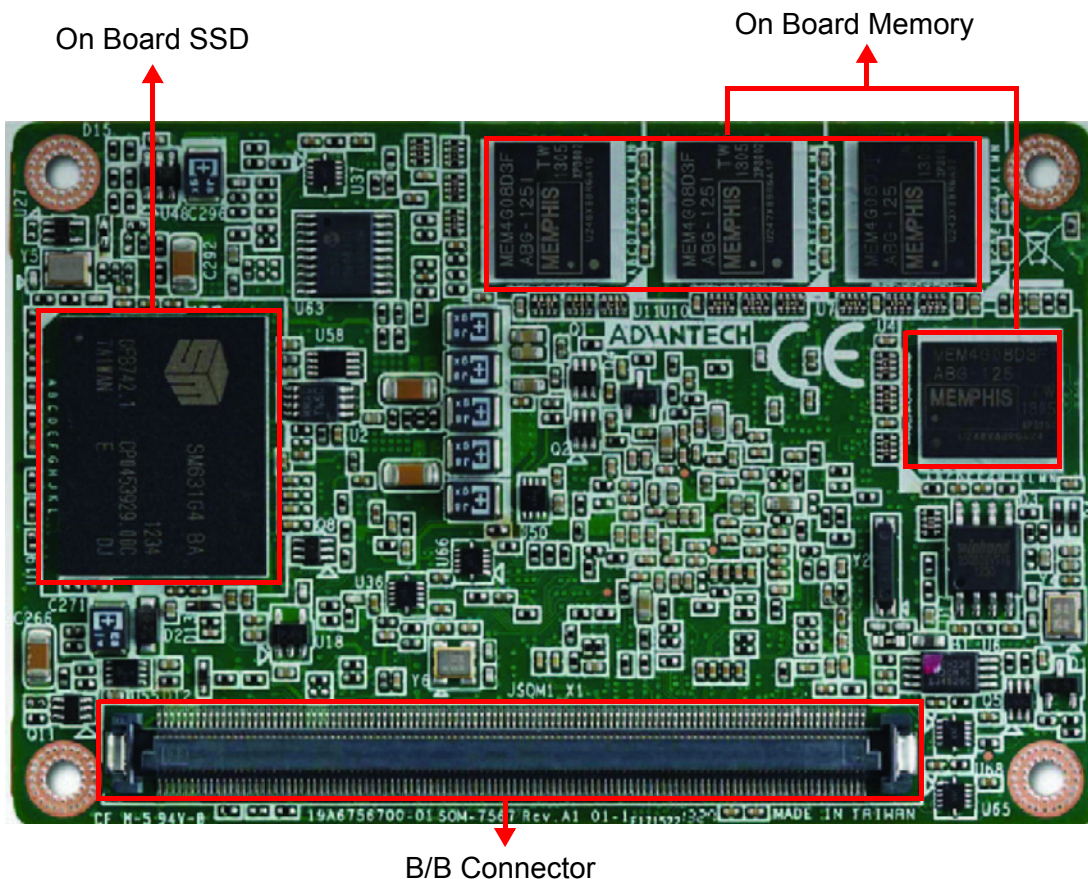

Figure 2.1 Board Chips Identify - Front





B/B Connector  
**Figure 2.2 Board Chips Identify - Back**

## 2.2 Mechanical Drawing

For more details about 2D/3D models, please find info on Advantech's COM support service website <http://com.advantech.com>.

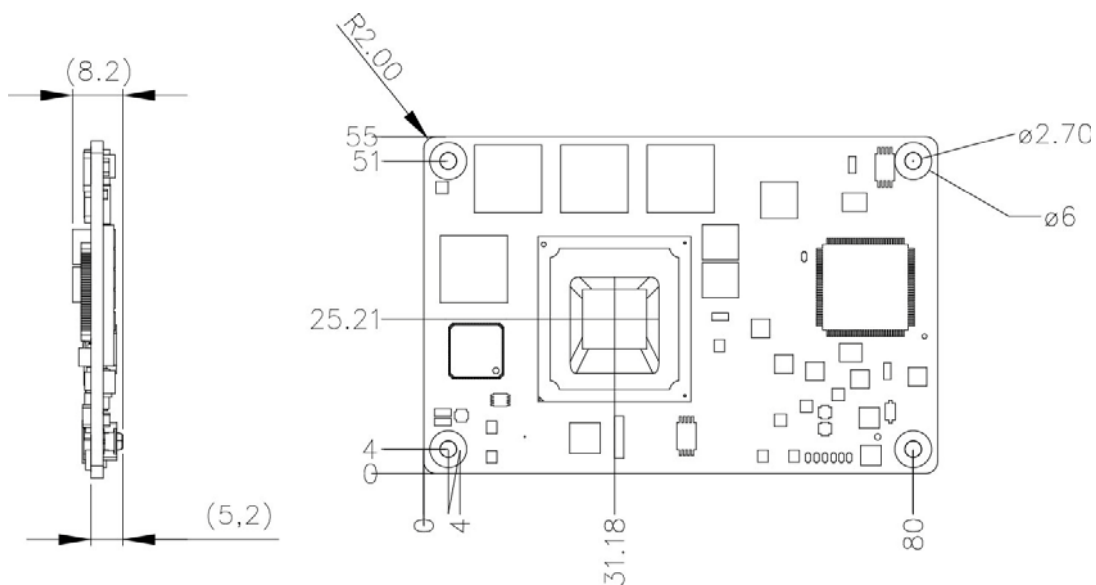

**Figure 2.3 Board Mechanical Drawing - Front**

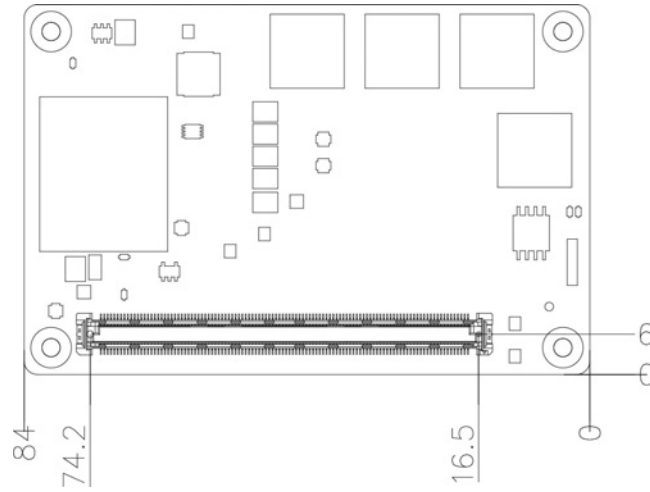

**Figure 2.4 Board Mechanical Drawing - Back**

## **2.3 Assembly Drawing**

These figures demonstrate the assembly order from thermal module, COM module to carrier board.

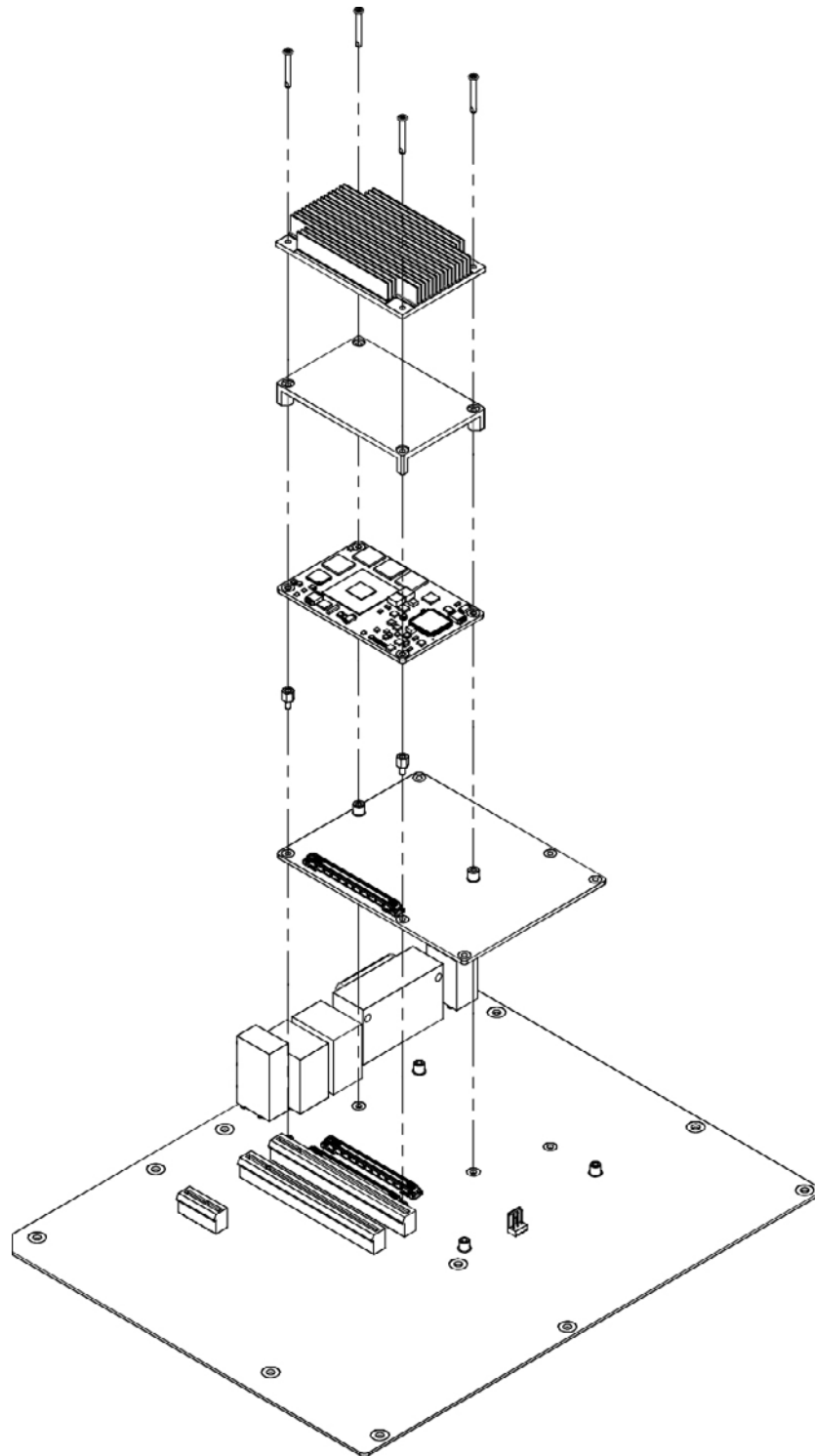
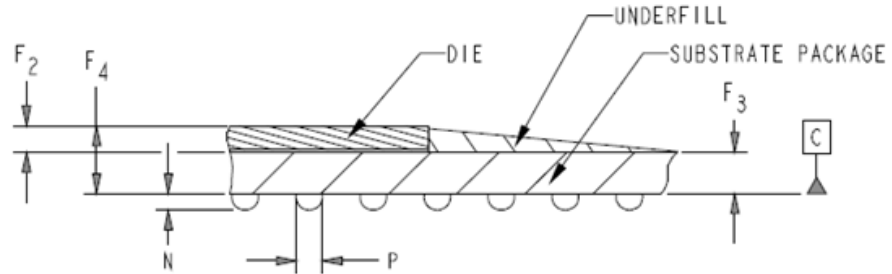

Figure 2.5 Assembly Drawing

## 2.4 Main Chip Height

Please consider the CPU and chip height tolerance when designing your thermal solution.



SYMBOL	Millimeter		Comments
	NOM.	TOL.	
F2	0.412	+ - 0.018	
F3	0.648	+ - 0.075	
F4	1.06	+ - 0.077	
N	0.257	+ - 0.05	Pre-SMT BGA Height
	0.222	+ - 0.06	Post-SMT BGA Height
P	0.404	+ - 0.05	Pre-SMT BGA Ball Diameter

# Chapter 3

## BIOS

This chapter gives BIOS setup information for the SOM-7567 Computer on Module board

Sections include:

- Introduction
- Entering Setup
- Hot / Operation Key
- Exit BIOS Setup Utility
- Enable USB 3.0
- BIOS/FW Supported Matrix

## 3.1 Entering Setup

SOM-7567 BIOS has been stored into a flash ROM which is soldered on board. With the BIOS Setup program, users can modify BIOS settings and control various system features. This chapter describes the basic navigation of the SOM-7567 BIOS setup screens.

Advantech will have revision for product optimization, and users can re-flash the latest BIOS through AFU utility. Please contact to Advantech sales or FAE for more details.

Turn on the computer and then press <ESC> or <DEL> to enter Setup menu.



**Figure 3.1 Setup Program Initial Screen**

SOM-7567 BIOS has a built-in Setup program that allows users to modify the basic system configuration. This information is stored in flash ROM so it retains the Setup information when the power is turned off.

## 3.2 Main Setup

When users first enter the BIOS Setup Utility, users will enter the Main setup screen. Users can always return to the Main setup screen by selecting the Main tab. There are two Main Setup options. They are described in this section. The Main BIOS Setup screen is shown below.



**Figure 3.2 Main Setup Screen**

The Main BIOS setup screen has two main frames. The left frame displays all the options that can be configured. Grayed-out options cannot be configured; options in blue can. The right frame displays the key legend.

Above the key legend is an area reserved for a text message. When an option is selected in the left frame, it is highlighted in white. Often a text message will accompany it.

- **System time / System date**  
Use this option to change the system time and date. Highlight System Time or System Date using the <Arrow> keys. Enter new values through the keyboard. Press the <Tab> key or the <Arrow> keys to move between fields.
  - System Date: mm/dd/yyyy
  - System Time: hh/mm/ss

### 3.3 Advanced BIOS Features Setup

Select the Advanced tab from the SOM-7567 setup screen to enter the Advanced BIOS Setup screen. Users can select any item in the left frame of the screen, such as CPU Configuration, to go to the sub menu for that item. Users can display an Advanced BIOS Setup option by highlighting it using the <Arrow> keys. All Advanced BIOS Setup options are described in this section. The Advanced BIOS Setup screens are shown below. The sub menus are described on the following pages.

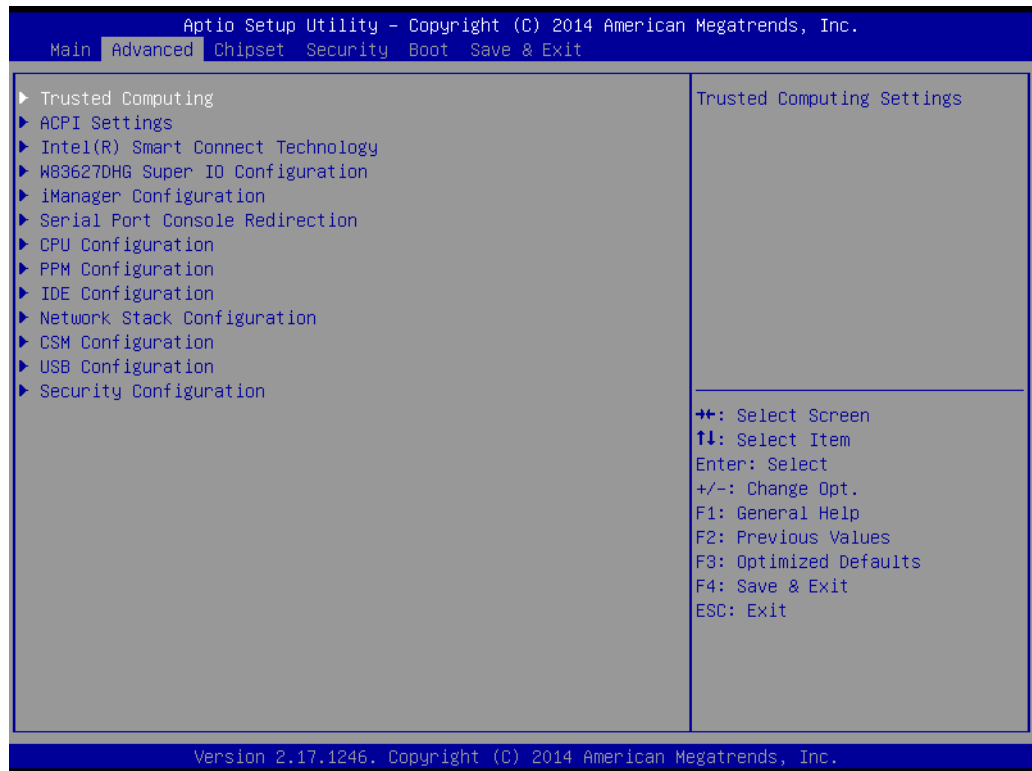

**Figure 3.3 Advanced BIOS Features Setup Screen**



### 3.3.1 Trusted Computing

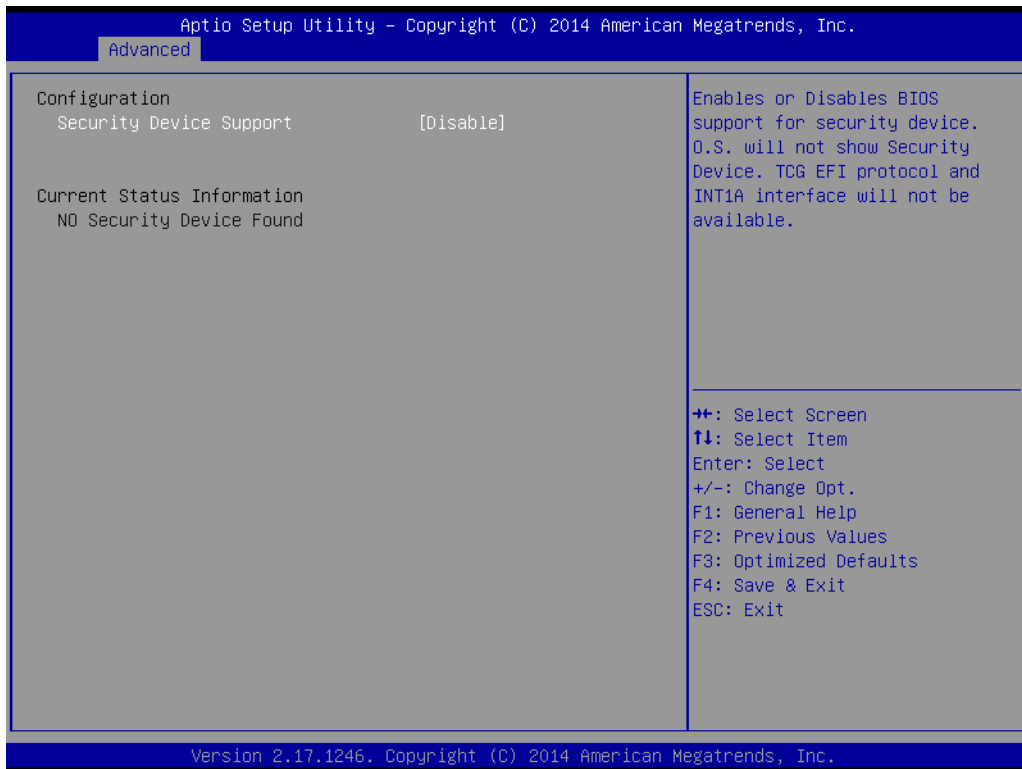

**Figure 3.4 Trusted Computing Settings**

- **Security Device Support**  
This item allows users to enable or disable BIOS support for security device.

## 3.3.2 ACPI Settings

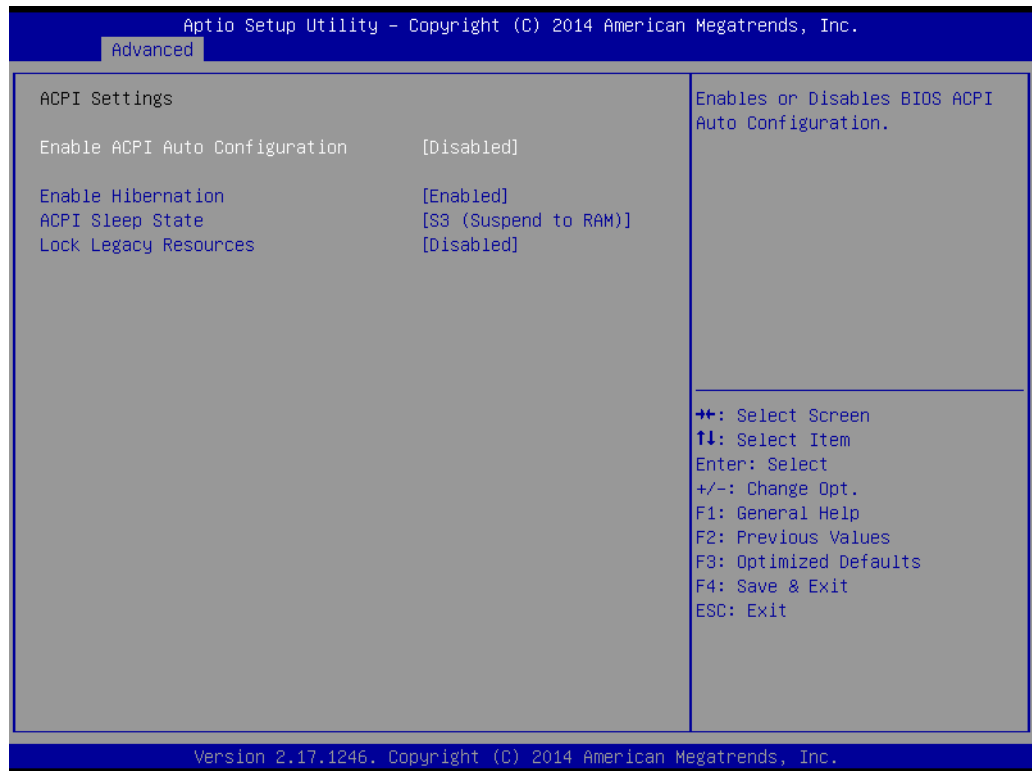

Figure 3.5 ACPI Settings

- **Enable ACPI Auto Configuration**  
This item allows users to enable or disable BIOS ACPI auto configuration.
- **Enable Hibernation**  
This item allows users to enable or disable hibernation.
- **ACPI Sleep State**  
This item allows users to set the ACPI sleep state.
- **Lock Legacy Resources**  
This item allows users to lock legacy devices' resources.

### 3.3.3 Intel(R) Smart Connect Technology



**Figure 3.6 Intel(R) Smart Connect Technology**

- **ISCT Support**  
Disable/Enable ISCT Support.

### 3.3.4 W83627DHG Super IO Configuration

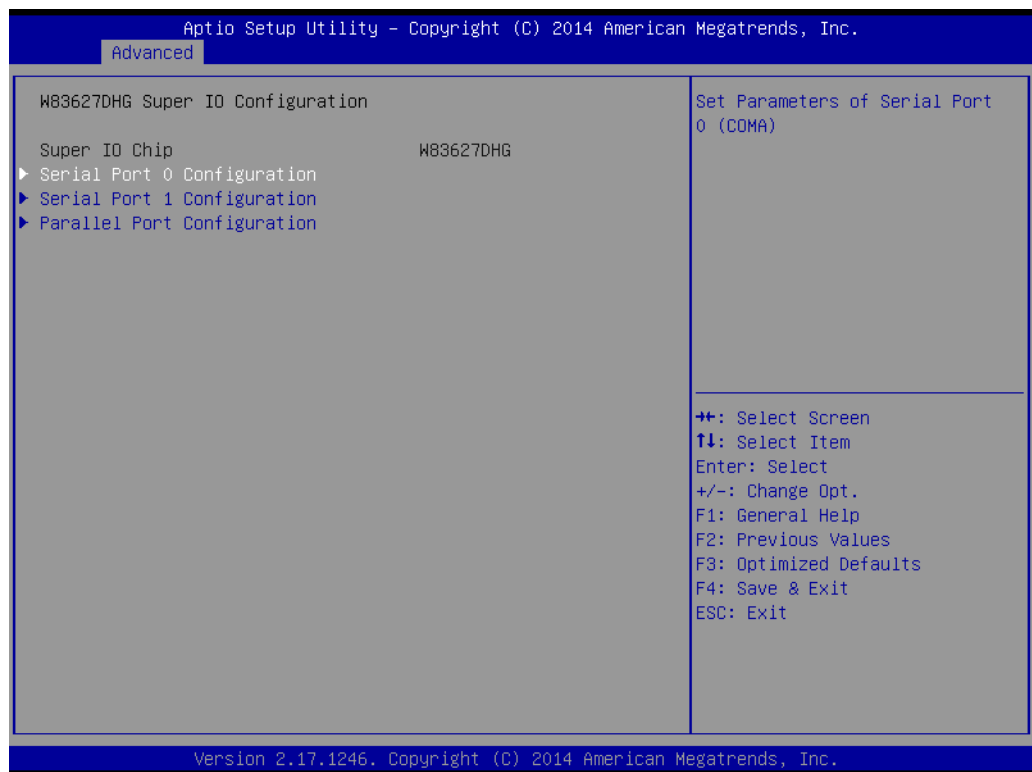

**Figure 3.7 W83627DHG Super IO Configuration**

- **Serial Port 0 Configuration**  
This item allows users to set parameters of Serial Port 0.
- **Serial Port 1 Configuration**  
This item allows users to set parameters of Serial Port 1.
- **Parallel Port Configuration**  
This item allows users to set parameters of Parallel Port (LPT/LPTE).

### 3.3.4.1 Serial Port 0 Configuration

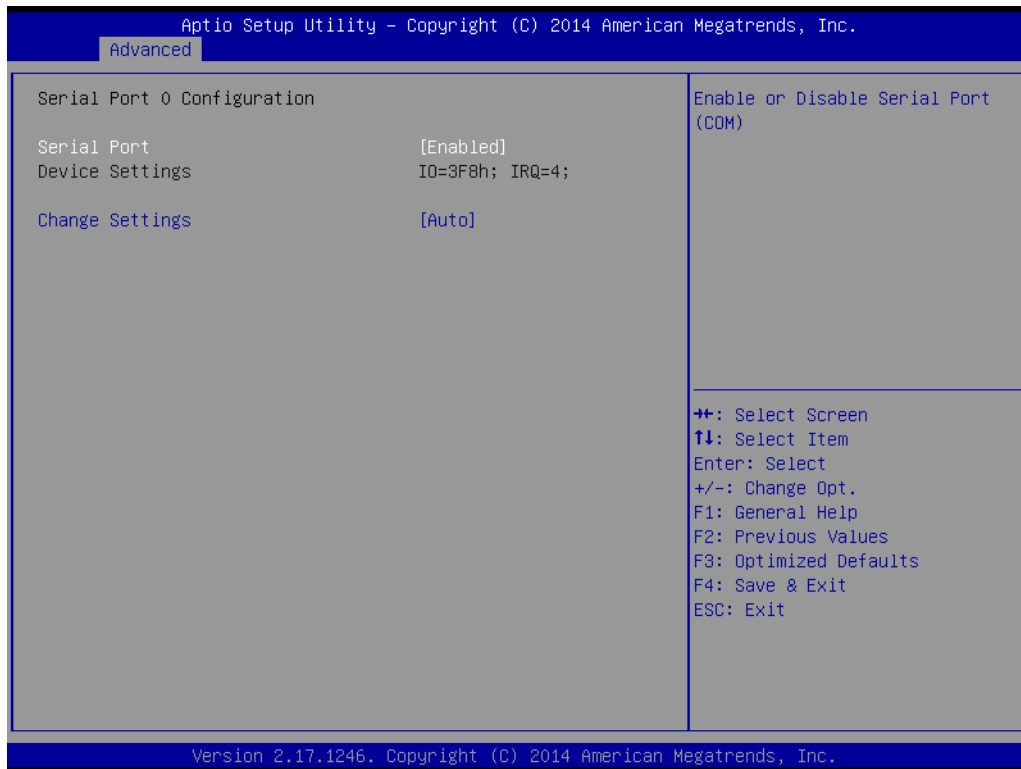

**Figure 3.8 Serial Port 0 Configuration**

- **Serial Port**  
This item allows users to enable or disable Serial Port (COM).
- **Change Setting**  
This item allows users to select optimal setting for the Super IO device.

### 3.3.4.2 Serial Port 1 Configuration

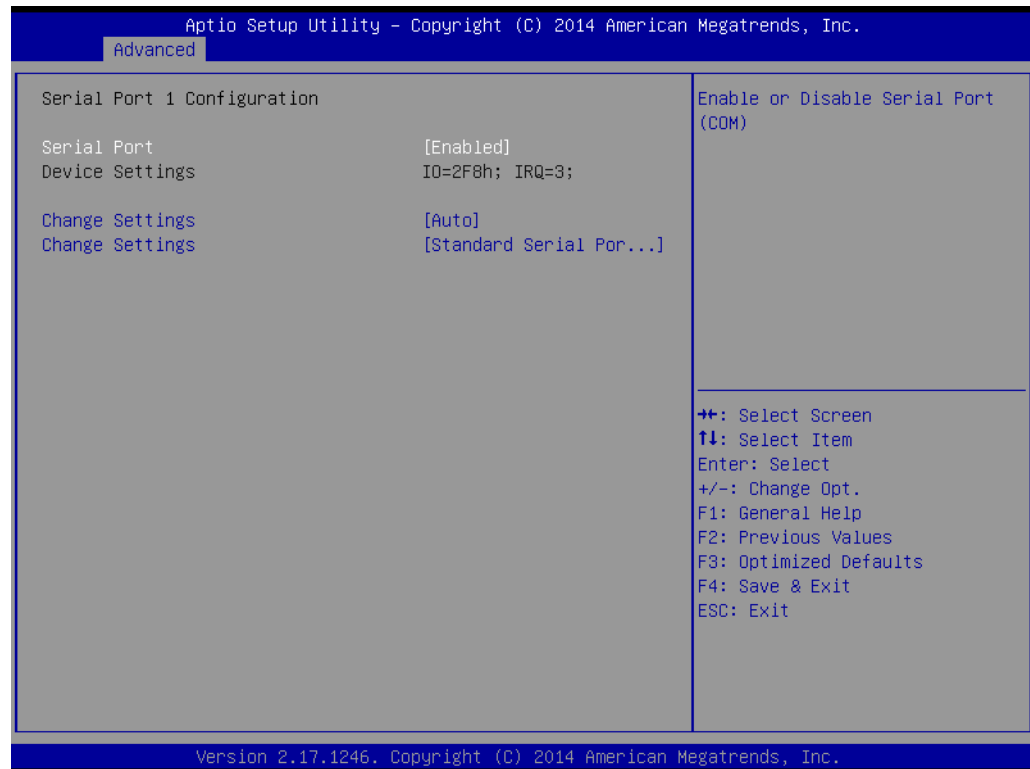

**Figure 3.9 Serial Port 1 Configuration**

- **Serial Port**  
This item allows users to enable or disable Serial Port (COM).
- **Change Setting**  
This item allows users to select optimal setting for the Super IO device.

### 3.3.4.3 Parallel Port Configuration

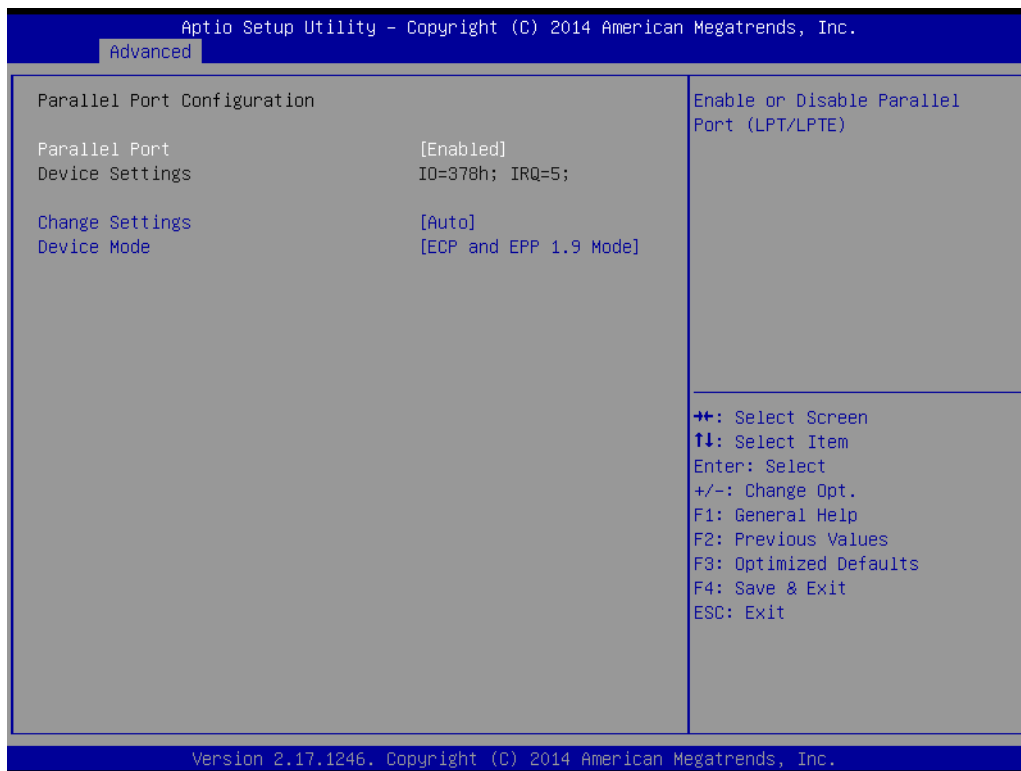

**Figure 3.10 Parallel Port Configuration**

- **Parallel Port**  
This item allows users to enable or disable Parallel Port (LPT/LPTE).
- **Change Setting**  
This item allows users to select optimal setting for the Super IO device.
- **Device Mode**  
This item allows users to change the Printer Port mode.

### 3.3.5 iManager Configuration

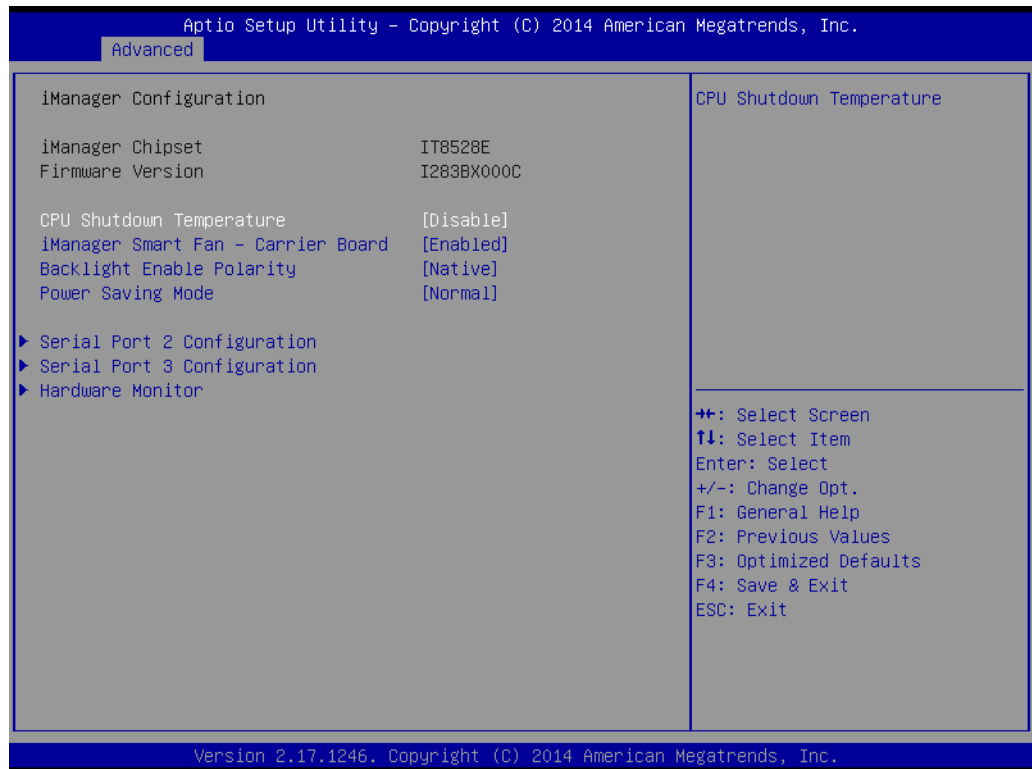

Figure 3.11 iManager Configuration

- **CPU Shutdown Temperature**  
This item allows users to select CPU Shutdown Temperature.
- **iManager Smart Fan – Carrier Board**  
This item allows users to control iManager Smart function in Carrier Board.
- **Backlight Enable Polarity**  
This item allows users to switch backlight enable polarity for Native or Invert.
- **Power Saving Mode**  
This item allows users to select Ite8518 Power Saving Mode.
- **Serial Port 2 Configuration**  
Set parameter of Serial Port 2.
- **Serial Port 3 Configuration**  
Set parameter of Serial Port 3.
- **Hardware Monitor**  
This item allows users to monitor hardware status.



### 3.3.5.1 Serial Port 2 Configuration



**Figure 3.12 Serial Port 2 Configuration**

- **Serial Port**  
Customer can enables or disables Serial Port (COM).
- **Change settings**  
Users can select an optional setting for Serial Port.

### 3.3.5.2 Serial Port 3 Configuration

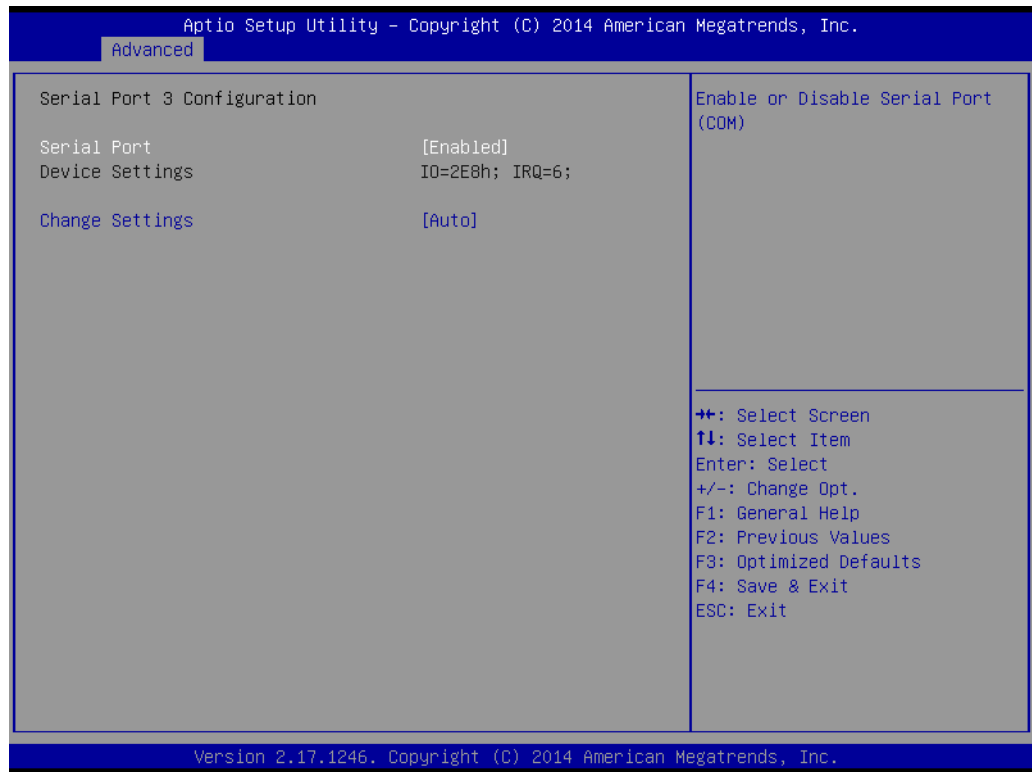

**Figure 3.13 Serial Port 3 Configuration**

- **Serial Port**  
COM Port 3 enables or disables Serial Port (COM).
- **Change settings**  
Users can select an optional setting for Serial Port.

### 3.3.5.3 Hardware Monitor

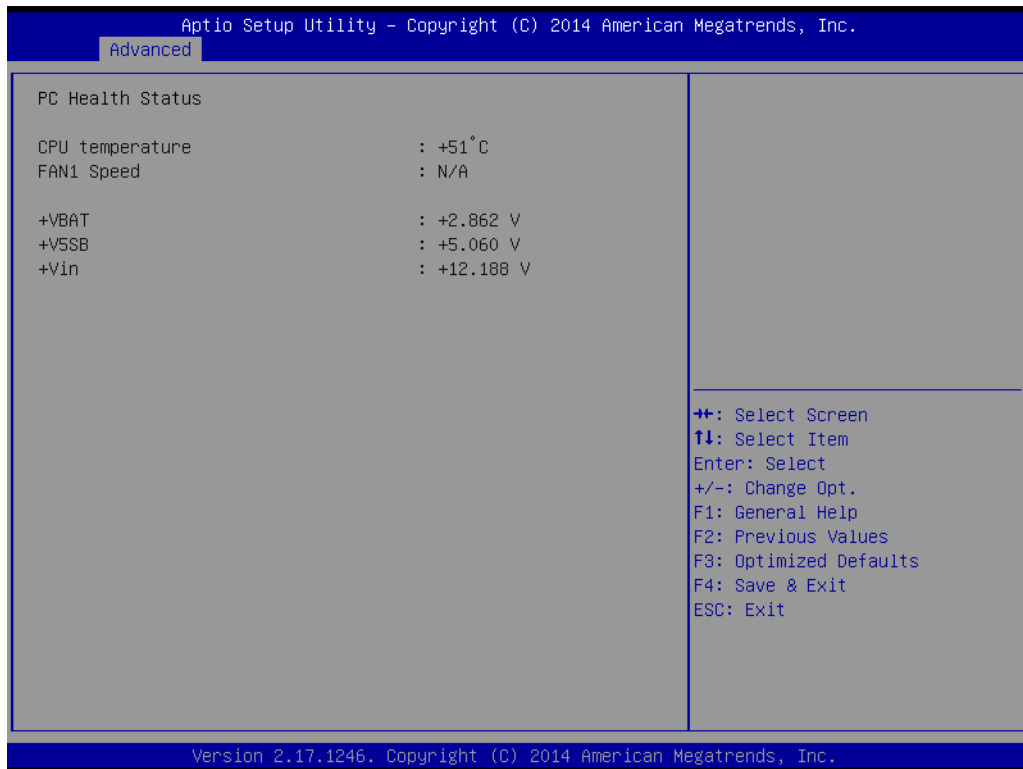

**Figure 3.14 Hardware Monitor**

### 3.3.6 Serial Port Console Redirection

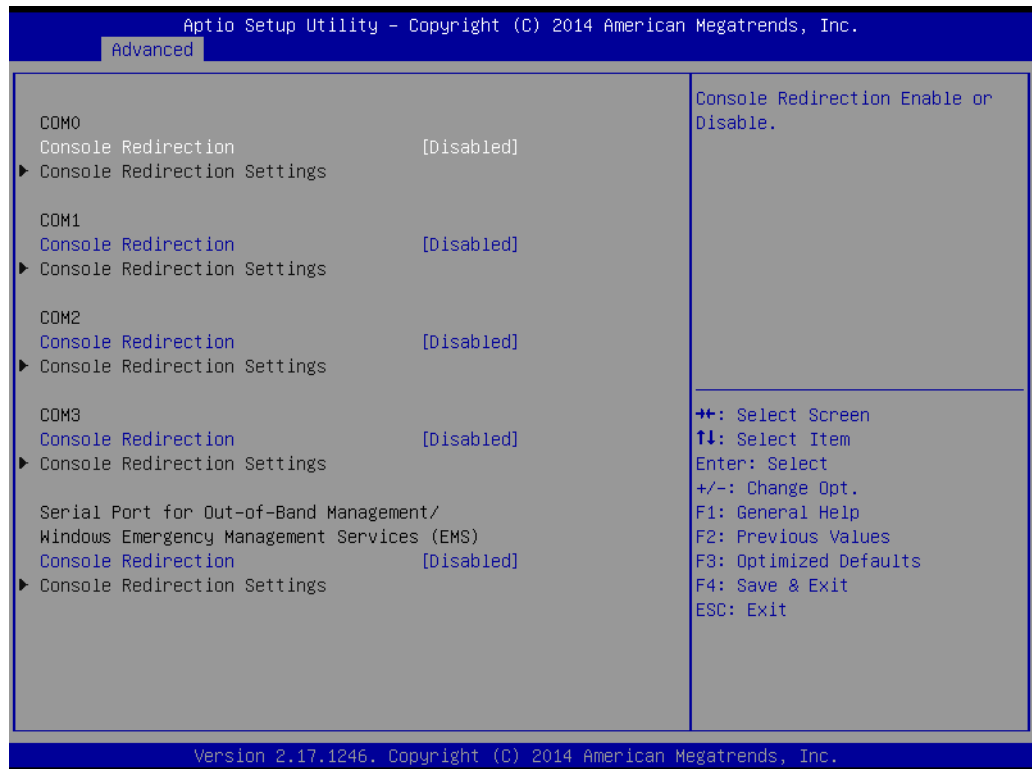

**Figure 3.15 Serial Port Console Redirection**

- **Console Redirection**  
This item allows users to enable or disable console redirection for Microsoft Windows Emergency Management Services (EMS).

### 3.3.7 CPU Configuration

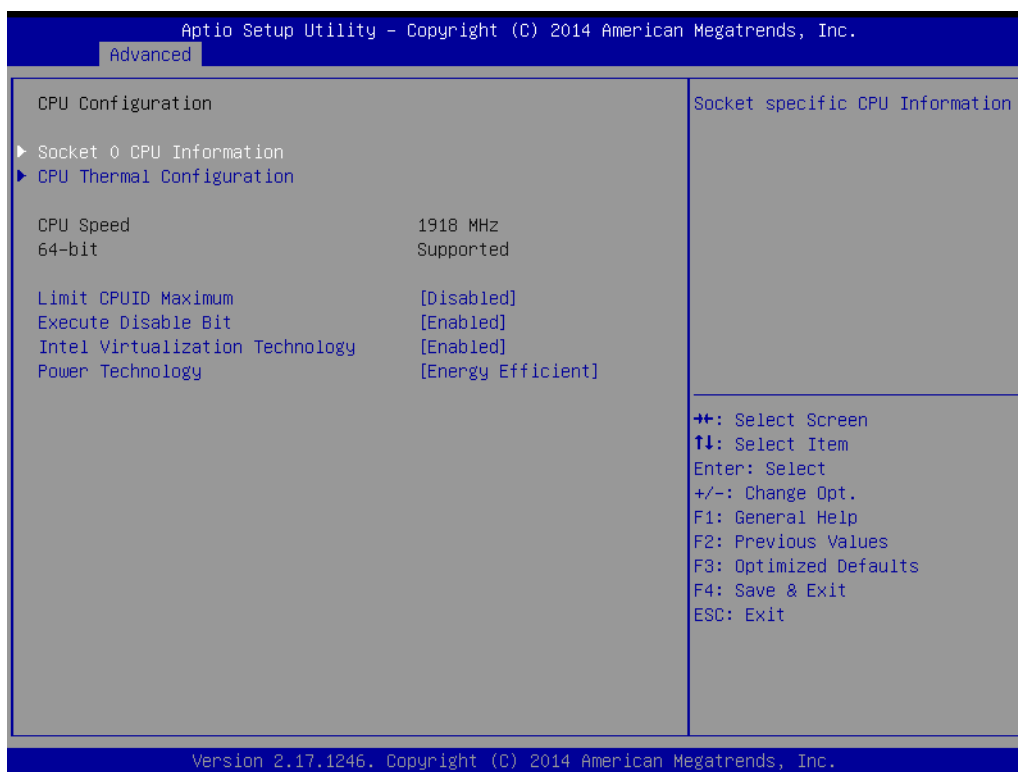

**Figure 3.16 CPU Redirection**

- **Socket 0 CPU Configuration**  
This item allows user to set Socket 0 CPU Configuration.
- **CPU Thermal Configuration**  
This item allows user to set CPU Thermal Configuration.
- **Limit CPUID Maximum**  
Disabled for Windows XP.
- **Execute Disable Bit**  
XD can prevent certain classes of malicious buffer overflow attacks when combined with a supporting OS (Windows Server 2003 SP1, Windows XP SP2, SuSE Linux 9.2, RedHat Enterprise 3 Update 3.).
- **Intel Virtualization Technology**  
When enabled, a VMM can utilize the additional hardware capabilities provided by Vanderpool Technology.
- **Power Technology**  
This item allows users to enable the power management features.

### 3.3.7.1 Socket 0 CPU Information

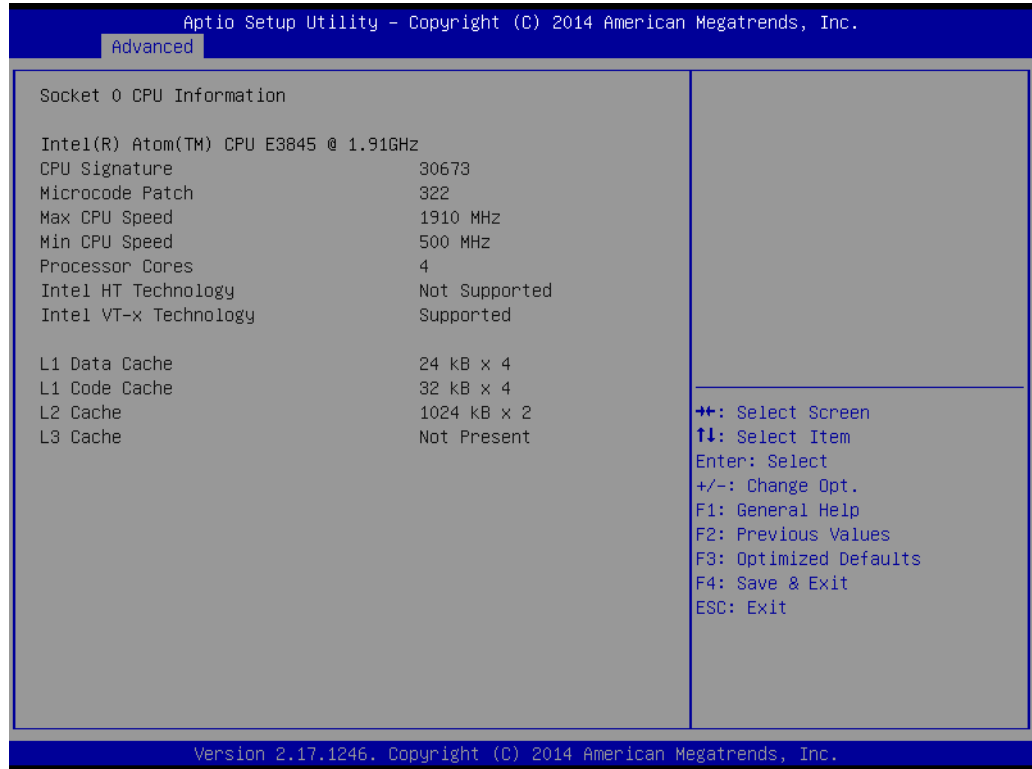

**Figure 3.17 Socket 0 CPU Information**

### 3.3.7.2 CPU Thermal Configuration



**Figure 3.18 CPU Thermal Configuration**

- **DTS**  
This item allows users to enable Digital Thermal Sensor.

### 3.3.8 PPM Configuration

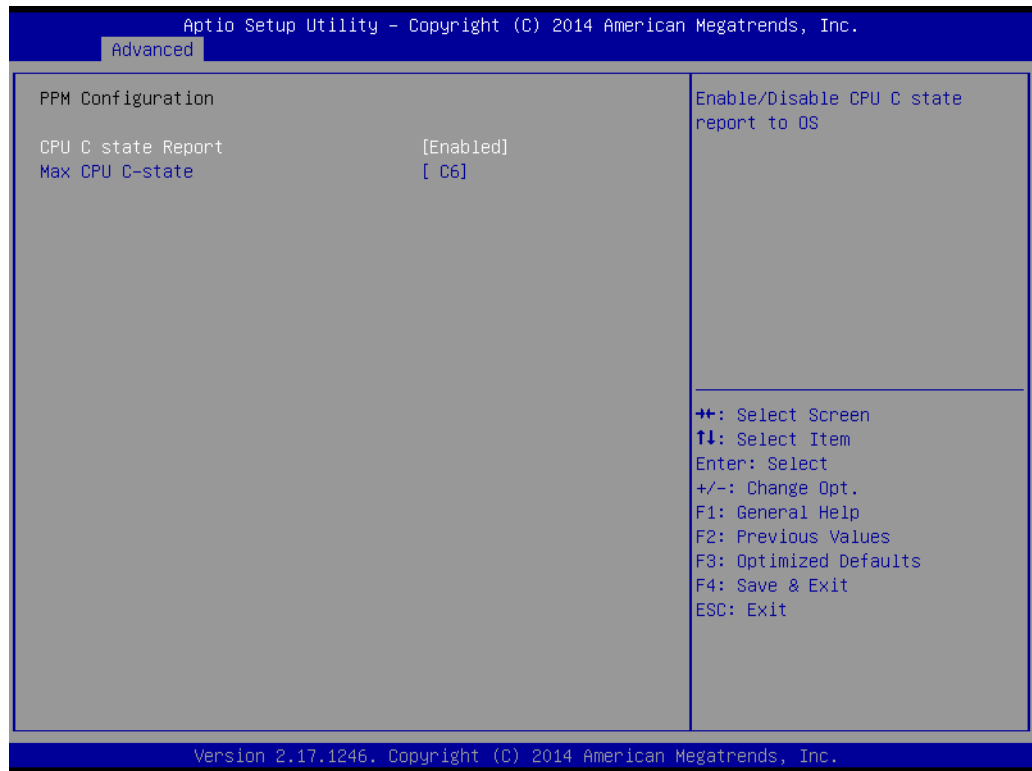
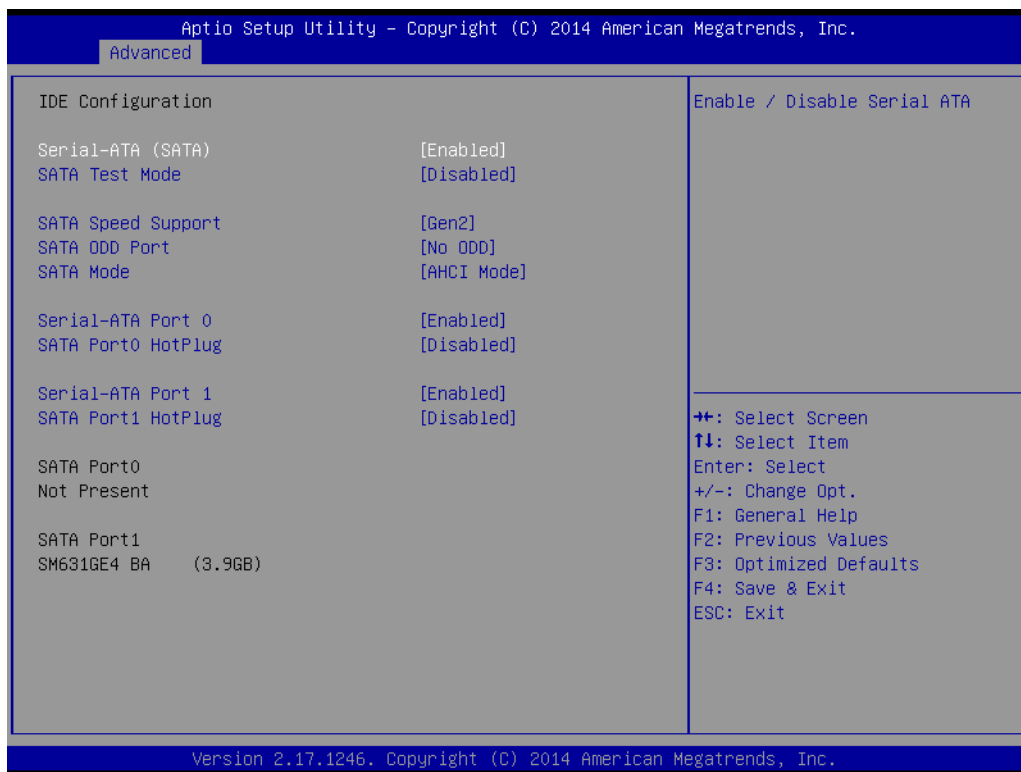

**Figure 3.19 PPM Configuration**

- **CPU C state Report**  
This item allows users to enable CPU C state report to OS.
- **Max CPU C-state**  
This option controls Max C state that the processor will support.



### 3.3.9 IDE Configuration



**Figure 3.20 IDE Configuration**

- **Serial-ATA (SATA)**  
This item allows users to enable or disable Serial ATA.
- **SATA Test Mode**  
This item allows users to enable or disable SATA Test mode.
- **SATA Speed Support**  
This item allows users to select SATA speed support in Gen1 or Gen2.
- **SATA ODD Port**  
This item allows users to select SATA ODD Port.
- **SATA Mode**  
This item allows users to select IDE/AHCI SATA mode.
- **Serial-ATA Port 0**  
This item allows users to enable or disable Serial ATA Port 0.
- **SATA Port0 HotPlug**  
This item allows users to enable or disable SATA Port0 Hotplug.
- **Serial-ATA Port 1**  
This item allows users to enable or disable Serial ATA Port 1.
- **SATA Port1 HotPlug**  
This item allows users to enable or disable SATA Port1 Hotplug.

### 3.3.10 Network Stack Configuration



**Figure 3.21 Network Stack Configuration**

- **Network Stack**  
This item allows users to enable or disable UEFI Network Stack.

### 3.3.11 CSM Configuration



Figure 3.22 CSM Configuration

- **CSM Support**  
This item allows users to enable or disable CSM Support.
- **GateA20 Active**  
This item allows users to select the timing to active GateA20.
- **Option ROM Messages**  
This item allows user to set display mode for Option ROM.
- **Boot option filter**  
This option controls Legacy/UEFI ROMs priority.
- **Network**  
This item controls the execution of UEFI and Legacy PXE OpROM.
- **Storage**  
This item controls the execution of UEFI and Legacy Storage OpROM.
- **Video**  
This item controls the execution of UEFI and Legacy Video OpROM.
- **Other PCI devices**  
This item determines OpROM execution policy for devices other than Network, Storage, or Video.

## 3.3.12 USB Configuration



Figure 3.23 USB Configuration

- **Legacy USB Support**  
This item allows users to enable or disable Legacy USB Support.
- **XHCI Hand-off**  
This is a workaround for OSeS without XHCI hand-off support. The XHCI ownership change should be claimed by XHCI driver.
- **EHCI hand-off**  
This is a workaround for OS without EHCI hand-off support. The EHCI ownership change should be claimed by EHCI driver.
- **USB Mass Storage Driver Support**  
This item allows users to enable or disable USB Mass Storage Driver Support.
- **USB transfer time-out**  
The time-out value for Control, Bulk, and Interrupt transfers.
- **Device reset time-out**  
USB mass storage device Start Unit command time-out.
- **Device power-up delay**  
Maximum time the device will take before it properly reports itself to the Host Controller. "Auto" uses default value: for a Root port it is 100ms, for 1 Hub port the delay is taken from Hub descriptor.

### 3.3.13 Security Configuration

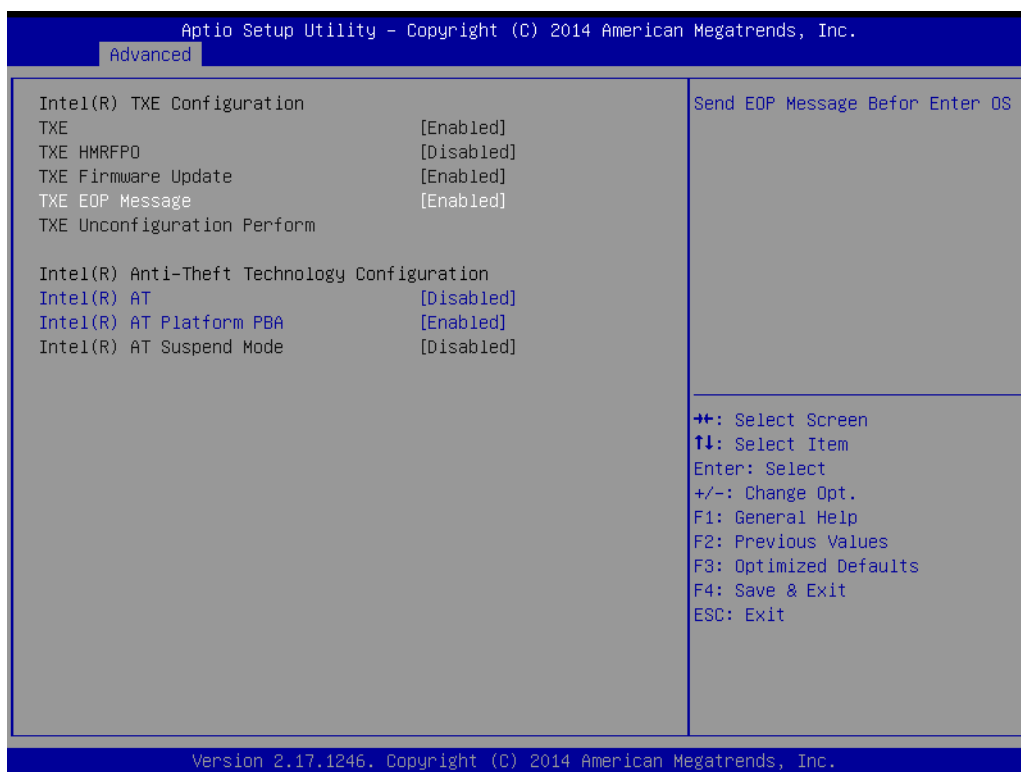

**Figure 3.24 Security Configuration**

- **TXE**  
This item allows users to enable or disable TXE support.
- **TXE HMRFPD**  
This item allows users to enable or disable TXE HMRFPD.
- **TXE Firmware Update**  
This item allows users to enable or disable TXE Firmware update.
- **TXE EOP Message**  
This item allows users to send EOP Message before enter OS.
- **TXE Unconfiguration Perform**  
This item allows users to revert TXE settings to factory defaults.
- **Intel(R) AT**  
This item allows users to enable/disable BIOS AT Code from running.
- **Intel(R) AT Platform PBA**  
This item allows users to enable/disable BIOS AT Code from running.

## 3.4 Chipset

Select the Chipset tab from the SOM-7567 setup screen to enter the Chipset BIOS Setup screen. You can display a Chipset BIOS Setup option by highlighting it using the <Arrow> keys. All Plug and Play BIOS Setup options are described in this section. The Plug and Play BIOS Setup screen is shown below.

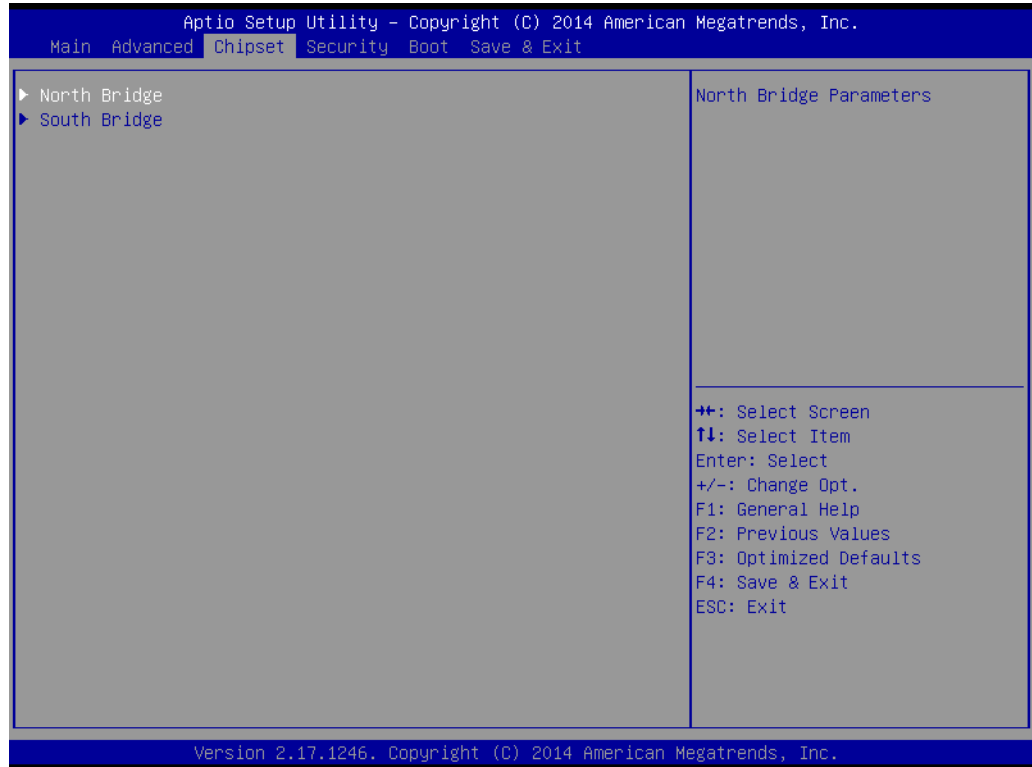
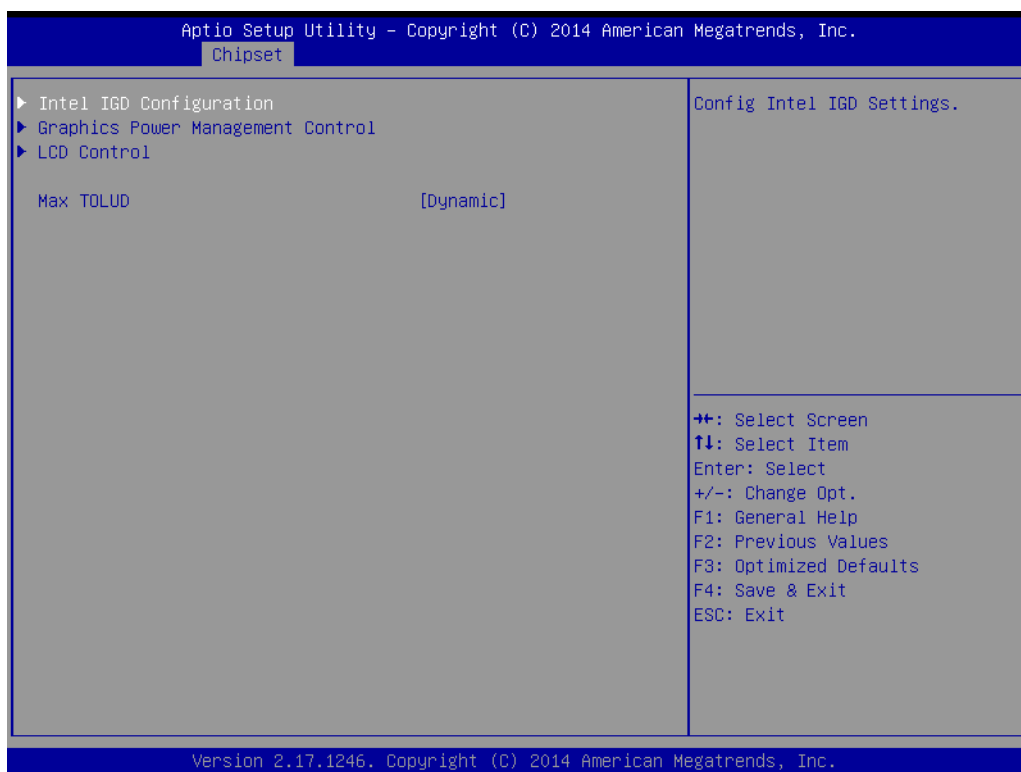

Figure 3.25 Chipset Setup

- **North Bridge**  
This item allows users to set North Bridge parameters.
- **South Bridge**  
This item allows users to set South bridge parameters.

### 3.4.1 North Bridge



**Figure 3.26 North Bridge**

- **Intel IGD Configuration**  
This item allows users to configure Intel IGD Settings.
- **Graphics Power Management Control**  
This item allows users to configure Graphics Power Management Control options.
- **LCD Control**  
This item allows users to control LCD setting.
- **MAX TOLUD**  
This item allows users to set Maximum value of TOLUD.

### 3.4.1.1 Intel IGD Configuration

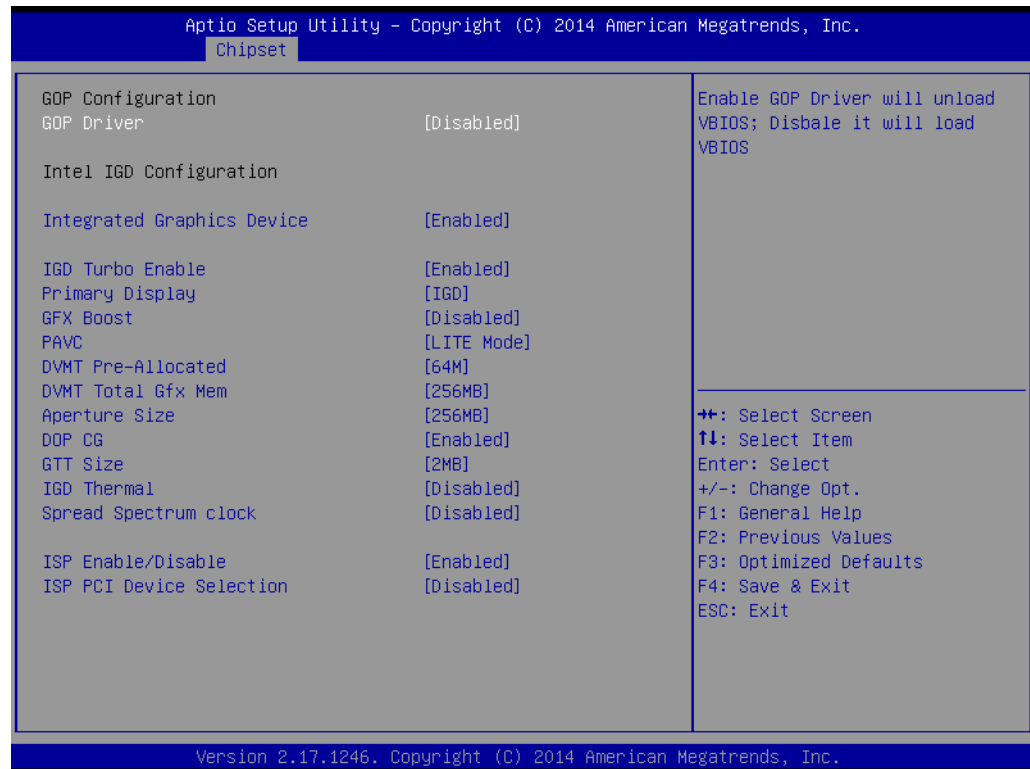

**Figure 3.27 Intel IGD Configuration**

- **GOP Driver**  
This item allows users to enable or disable GOP Driver. Enable GOP driver will unload VBIOS; Disable it will load VBIOS.
- **Integrated Graphics Device**  
This item allows users to enable or disable Integrated Graphics Device.
- **IGD Turbo Enable**  
This item allows users to enable or disable IGD Turbo.
- **Primary Display**  
This item allows users to select which of IGD/PCI Graphics device should be primary Display.
- **GFX Boost**  
This item allows users to enable or disable GFX Boost
- **PAVC**  
This item allows users to enable or disable Protected Audio Video Control.
- **DVMT Pre-Allocated**  
This item allows users to select DVMT 5.0 Pre-Allocated (Fixed) Graphics Memory size used by the internal Graphics Device.
- **DVMT Total Gfx Mem**  
This item allows users to select DVMT 5.0 Total Graphics Memory size used by the internal Graphics Device.
- **Aperture Size**  
This item allows users to select Aperture Size.
- **DOP CG**  
This item allows users to enable/disable DOP Clock Gating.
- **GTT Size**  
This item allows users to select GTT Size.



- **IGD Thermal**  
This item allows users to enable/disable IGD Thermal.
- **Spread Spectrum clock**  
This item allows users to enable/disable Spread Spectrum clock.
- **ISP Enable/Disable**  
This item allows users to enable/disable ISP PCI Device Selection.
- **ISP PCI Device Enable/Disable**  
Default ISP is PCI B0D2F0 for Window Boot. Linux Boot to select B0D3G0.

### 3.4.1.2 Graphics Power Management Control

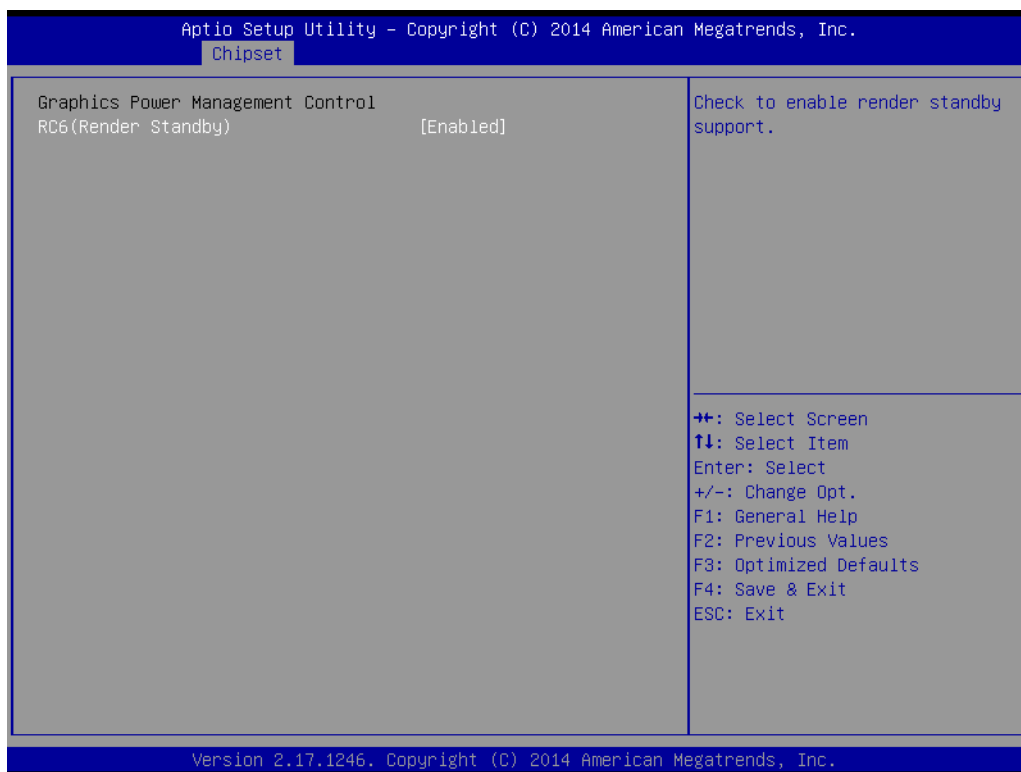

**Figure 3.28 Graphics Power Management Control**

- **RC6 (Render Standby)**  
This item allows users to enable/disable render standby support.

### 3.4.1.3 LCD Control



Figure 3.29 LCD Control

- **Primary IGFX Boot Display**  
Select the Video Device which will be activated during POST. This has no effect if external graphics present.
- **IGD Flat panel**  
This item allows users to select IGD Flat panel options.
- **Panel Scaling**  
This item allows users to select the LCD panel scaling option used by the Internal Graphics Device.
- **Backlight Control**  
This item allows users to select back light control setting.
- **Active LFP**  
This item allows users to select “No LVDS” or “eDP Port-A”.

## 3.4.2 South Bridge

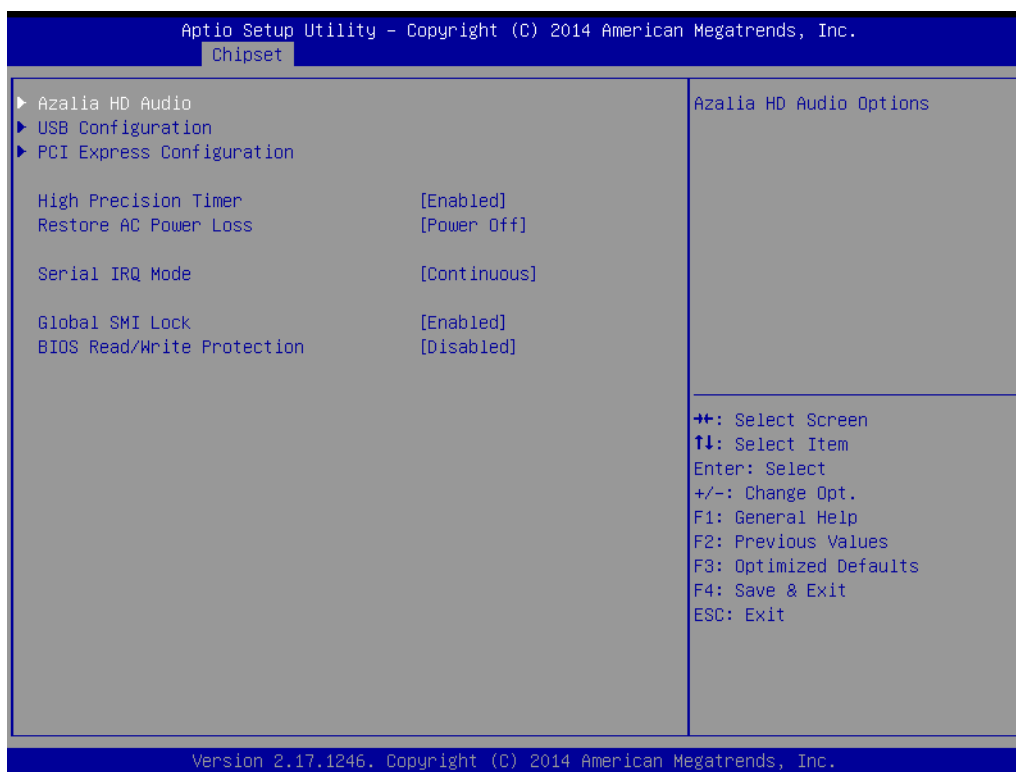

**Figure 3.30 South Bridge**

- **Azalia HD Audio**  
This item allows users to configure Azalia HD Audio Options.
- **USB Configuration**  
This item allows users to configure USB Configuration settings.
- **PCI Express Configuration**  
This item allows users to configure PCI Express Configuration settings.
- **High Precision Timer**  
This item allows users to enable/disable the High Precision Event Timer.
- **Restore AC Power Loss**  
This item allows users to select AC power state when power is re-applied after a power failure.
- **Serial IRQ Mode**  
This item allows users to configure Serial IRQ Mode.
- **Global SMI Lock**  
This item allows users to enable/disable SMI Lock.
- **BIOS Read/Write Protection**  
This item allows users to enable/disable BIOS SPI region read/write protect.

### 3.4.2.1 Azalia HD Audio

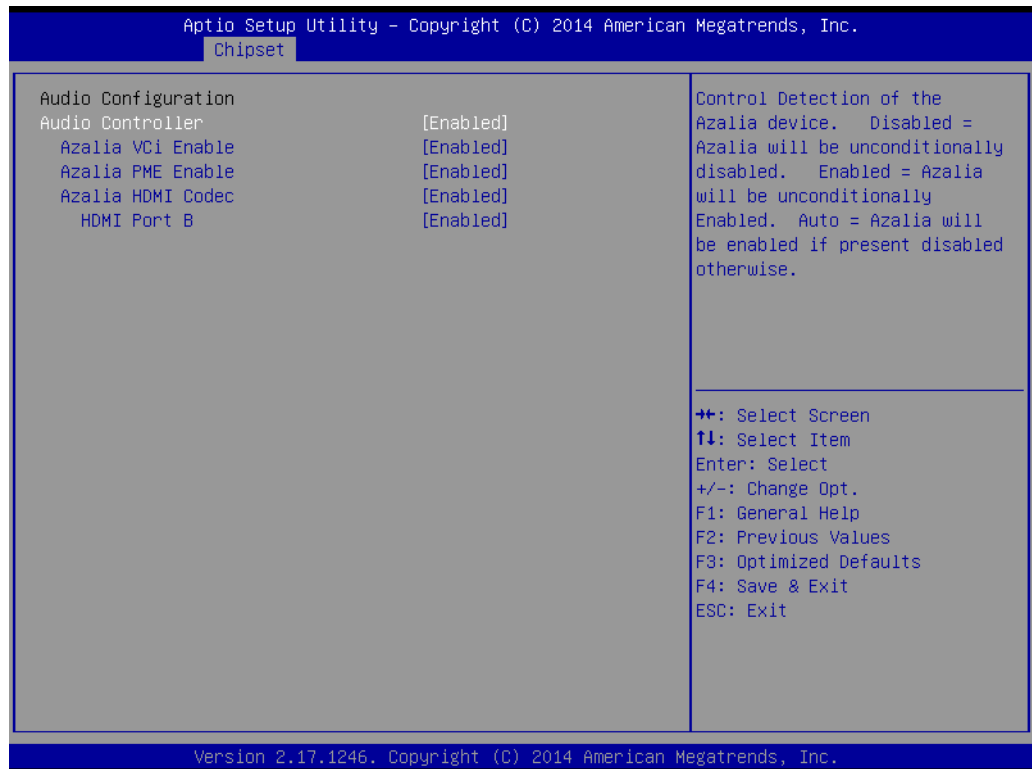

**Figure 3.31 Azalia HD Audio**

- **Audio Controller**  
This item allows users to control Detection of the Azalia Device.
- **Audio VCI Controller**  
This item allows users to enable/disable Virtual Channel 1 of Audio Controller.
- **Audio PME Controller**  
This item allows users to enable/disable Power Management capability of Audio Controller.
- **Audio HDMI Codec**  
This item allows users to enable/disable internal HDMI codec for Azalia.
- **HDMI Port B**  
This item allows users to enable/disable HDMI Port B.

### 3.4.2.2 USB Configuration

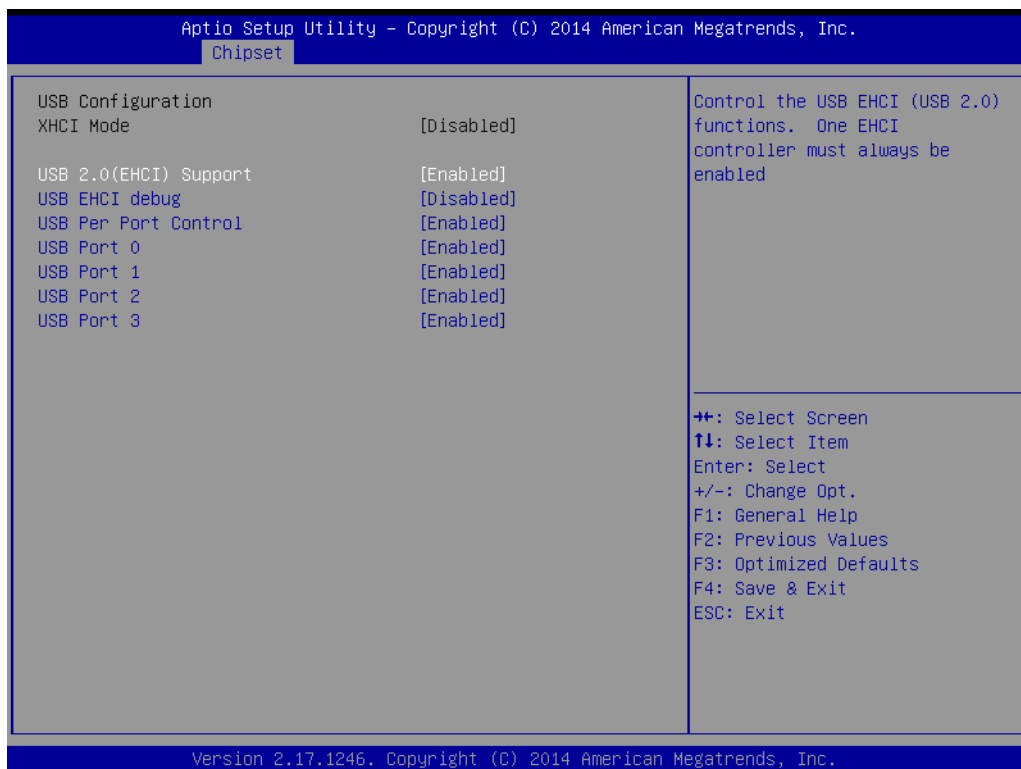

**Figure 3.32 USB Configuration**

- **USB 2.0 (EHCI) Support**  
This item allows users to control the USB EHCI (USB 2.0) functions. One EHCI controller must always be enabled.
- **USB EHCI debug**  
This item allows users to enable/disable PCH EHCI debug capability.
- **USB Per Port Control**  
This item allows users to control each of the USB ports (0~3).
- **USB Port 0**  
This item allows users to enable/disable USB Port 0.
- **USB Port 1**  
This item allows users to enable/disable USB Port 1.
- **USB Port 2**  
This item allows users to enable/disable USB Port 2.
- **USB Port 3**  
This item allows users to enable/disable USB Port 3.

### 3.4.2.3 PCI Express Configuration



Figure 3.33 PCI Express Configuration

- **PCI Express Port 0**  
This item allows users to enable/disable PCI Express Port 0 in the Chipset.
- **Hot Plug**  
This item allows users to enable/disable PCI Express Hot Plug.
- **Speed**  
This item allows users to configure PCIe Port Speed.
- **PCI Express Port 1**  
This item allows users to enable/disable PCI Express Port 1 in the Chipset.
- **Hot Plug**  
This item allows users to enable/disable PCI Express Hot Plug.
- **Speed**  
This item allows users to configure PCIe Port Speed.
- **PCI Express Port 2**  
This item allows users to enable/disable PCI Express Port 2 in the Chipset.
- **Hot Plug**  
This item allows users to enable/disable PCI Express Hot Plug.
- **Speed**  
This item allows users to configure PCIe Port Speed.
- **PCI Express Port 3 / LAN**  
This item allows users to enable/disable PCI Express Port 3 or onboard LAN.
- **Hot Plug**  
This item allows users to enable/disable PCI Express Hot Plug.
- **Speed**  
This item allows users to configure PCIe Port Speed.

## 3.5 Security

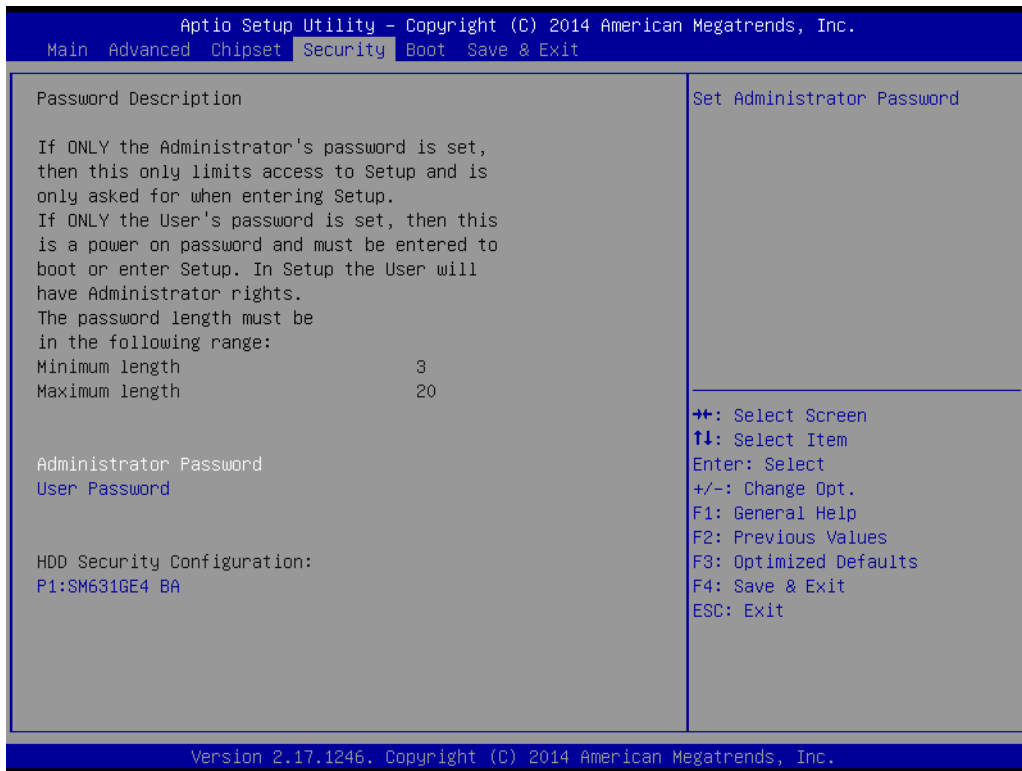

**Figure 3.34 Security**

- **Administrator Password**  
This item allows users to set Administrator Password.
- **User Password**  
This item allows users to set User Password.
- **P1: SM611GX8**  
HDD Security Configuration for selected driver.  
(This item will be shown if onboard SSD is available)

## 3.6 Boot

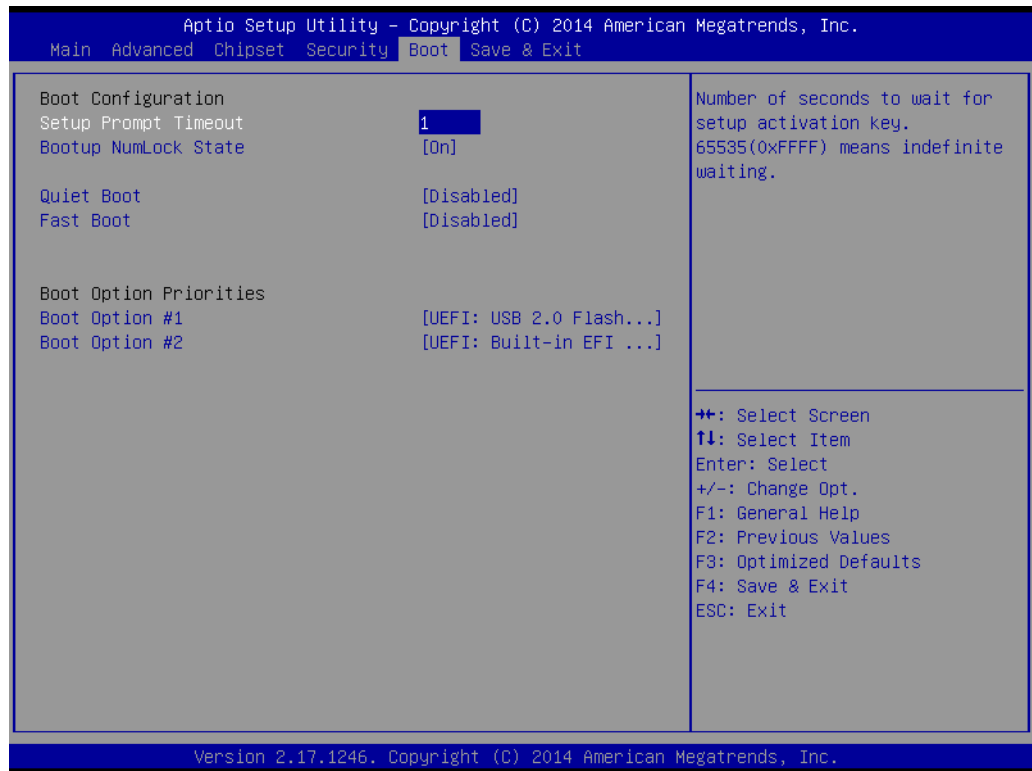

Figure 3.35 Security

- **Setup Prompt Timeout**  
This item allows users to select the number of seconds to wait for setup activation key.
- **Bootup NumLock State**  
This item allows users to select the Power-on state for Numlock.
- **Quiet Boot**  
This item allows users to enable or disable Quiet Boot option.
- **Fast Boot**  
This item allows users to enable or disable boot with initialization of a minimal set of devices required to launch active boot option. Has no effect for BBS boot options.
- **Boot Option Priority**  
This item allows users to set the system boot order.



## 3.7 Save & Exit



**Figure 3.36 Save & Exit**

- **Save Changes and Exit**  
When users have completed system configuration, select this option to save changes, exit BIOS setup menu and reboot the computer if necessary to take effect all system configuration parameters.
- **Discard Changes and Exit**  
Select this option to quit Setup without making any permanent changes to the system configuration.
- **Save Changes and Reset**  
When users have completed system configuration, select this option to save changes, exit BIOS setup menu and reboot the computer to take effect all system configuration parameters.
- **Discard Changes and Reset**  
Select this option to quit Setup without making any permanent changes to the system configuration and reboot the computer.
- **Save Changes**  
When users have completed system configuration, select this option to save changes without exit BIOS setup menu.
- **Discard Changes**  
Select this option to discard any current changes and load previous system configuration.
- **Restore Defaults**  
The SOM-7567 automatically configures all setup items to optimal settings when users select this option. Optimal Defaults are designed for maximum system performance, but may not work best for all computer applications. In particular, do not use the Optimal Defaults if the user's computer is experiencing system configuration problems.

- **Save as User Defaults**  
When users have completed system configuration, select this option to save changes as user defaults without exit BIOS setup menu.
- **Restore User Defaults**  
The users can select this option to restore user defaults.
- **Launch EFI Shell from filesystem device**  
Attempts to Launch EFI Shell application from one of the available file system devices.

## 3.8 Enable USB 3.0

To enable USB 3.0, please follow below procedure to enable USB 3.0(XHCI) driver.

1. Go to **Chipset -> South Bridge -> USB Configuration**

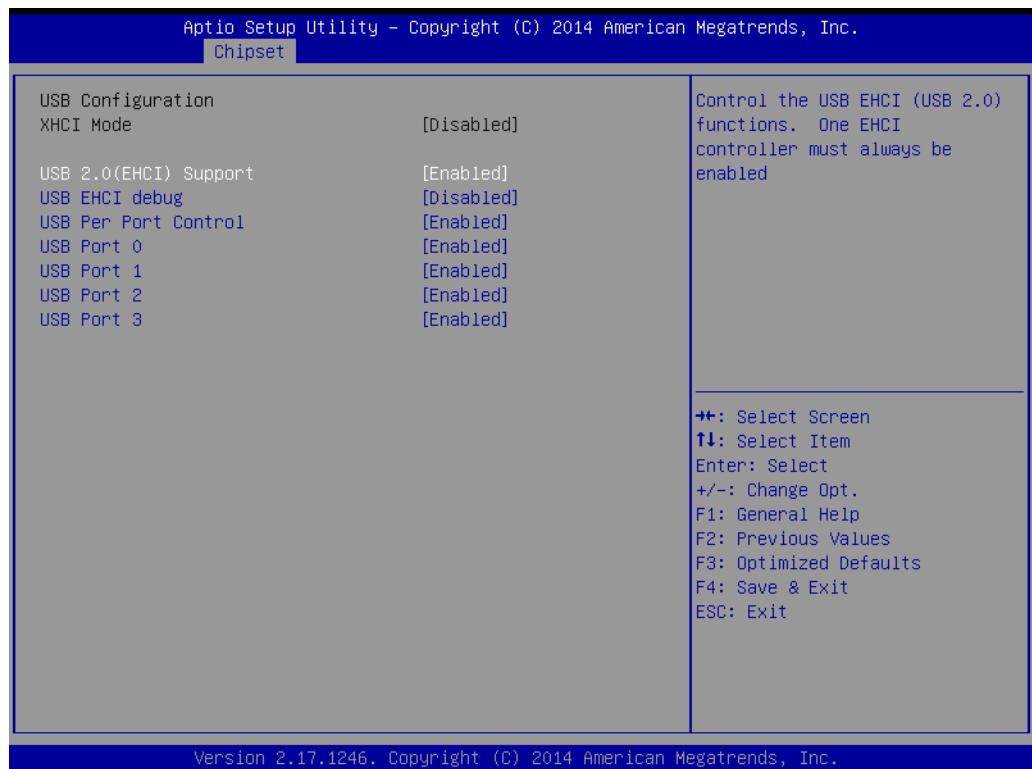

## 2. Select “Disable” in USB 2.0(EHCI) Support

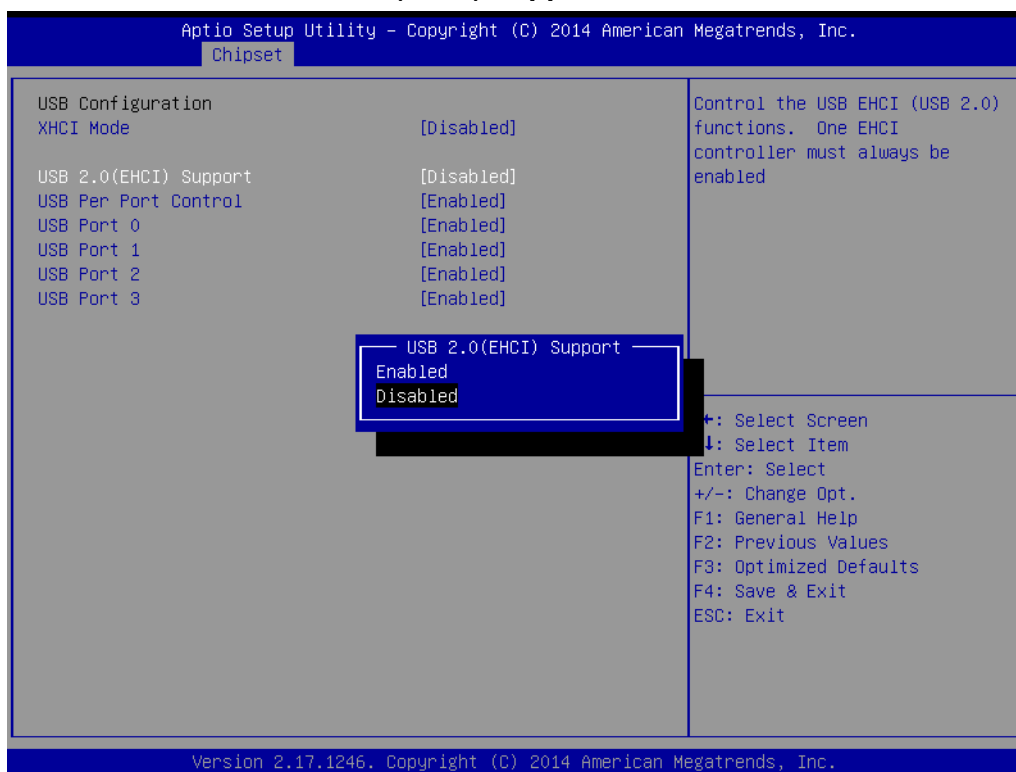

## 3. Select “Enable” in XHCI Mode

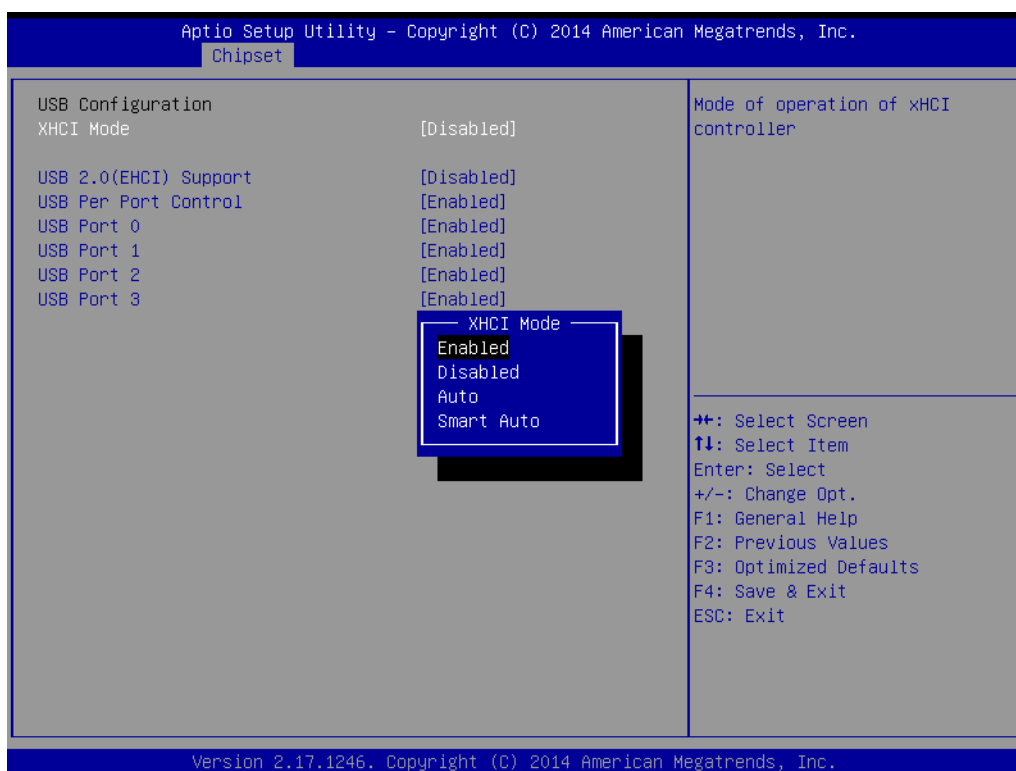

**Enable:** Enable XHCI Mode

**Disable:** Disable XHCI Mode

**Auto:** System will depend on previous boot setting in OS to enable/disable XHCI.

**Smart Auto:** System will depend on previous boot setting in POST and OS to enable/disable XHCI.

## 3.9 BIOS/FW Supported Matrix

Intel has defined BIOS/FW Supported Matrix as table underneath. Standard BIOS default is configured as legacy environment. If user wants to set EFI environment, please refer to chapter 3.9.1.

Operating System	BIOS Environment	VBIOS FW
Windows/WES 7	Legacy	VBIOS
Windows Embedded Compact7	(Default)	(Default)
Windows/WES 8		
Android	EFI	GOP
Linux (Fedora 18/Yocto 18)		

\* SOM-7567 standard product is configured with 64bis BIOS

### 3.9.1 Configure BIOS as EFI environment

Intel suggests using EFI environment for Windows/WES 8, Android and Linux. If user wants to change to EFI environment, please follow below procedure to modify BIOS.

1. Go to **Advanced -> CSM Configuration**, Configure following setting:
  - Boot option filter -> UEFI Only
  - Storage -> UEFI
  - Video -> UEFI
  - Other PCIe device -> UEFI

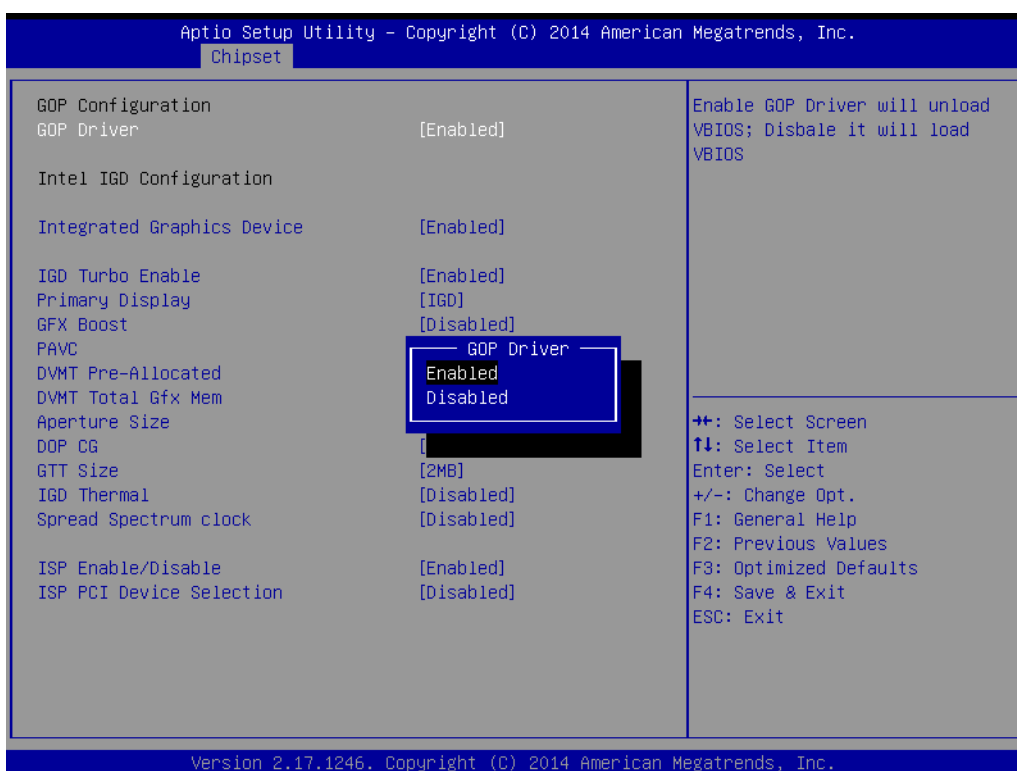

## 2. Save change and exit

3. Go to **Chipset** -> **North Bridge** -> **Intel IGD Configuration** -> **GOP driver**. Select "Enable" in GOP Driver4. Go to **Boot** and Select UEFI Boot options

## 5. Save change and exit.



# Chapter 4

## S/W Introduction & Installation

Sections include:

- S/W Introduction
- Driver Installation
- Advantech iManger

---

## 4.1 S/W Introduction

The mission of Advantech Embedded Software Services is to "Enhance quality of life with Advantech platforms and Microsoft Windows embedded technology." We enable Windows Embedded software products on Advantech platforms to more effectively support the embedded computing community. Customers are freed from the hassle of dealing with multiple vendors (Hardware suppliers, System integrators, Embedded OS distributor) for projects. Our goal is to make Windows Embedded Software solutions easily and widely available to the embedded computing community.

## 4.2 Driver Installation

The Intel Chipset Software Installation (CSI) utility installs the Windows INF files that outline to the operating system how the chipset components will be configured.

### 4.2.1 Windows XP / Windows 7 Driver Setup

To install the drivers please connect to internet and browse the website <http://support.advantech.com.tw> and download the drivers that you want to install and follow Driver Setup instructions to complete the installation.

### 4.2.2 Other OS

To install the drivers for Other Windows OS or Linux, please connect to internet and browse the website <http://support.advantech.com.tw> to download the setup file.

## 4.3 Advantech iManager

Advantech's platforms come equipped with iManager, a micro controller that provides embedded features for system integrators. Embedded features have been moved from the OS/BIOS level to the board level, to increase reliability and simplify integration. iManager runs whether the operating system is running or not; it can count the boot times and running hours of the device, monitor device health, and provide an advanced watchdog to handle errors just as they happen. iManager also comes with a secure & encrypted EEPROM for storing important security key or other customer define information. All the embedded functions are configured through API and provide corresponding utilities to demonstrate. These APIs comply with PICMG EAPI (Embedded Application Programmable Interface) specification and unify in the same structures. It makes these embedded features easier to integrate, speed up developing schedule, and provide the customer's software continuity while upgrade hardware. More detail of how to use the APIs and utilities, please refer to Advantech iManager 2.0 Software API User Manual.



## Control



**GPIO**

General Purpose Input/Output is a flexible parallel interface that allows a variety of custom connections. It allows users to monitor the level of signal input or set the output status to switch on/off a device. Our API also provides Programmable GPIO, which allows developers to dynamically set the GPIO input or output status.



**SMBus**

SMBus is the System Management Bus defined by Intel® Corporation in 1995. It is used in personal computers and servers for low-speed system management communications. The SMBus API allows a developer to interface an embedded system environment and transfer serial messages using the SMBus protocols, allowing multiple simultaneous device control.



**I2C**

I2C is a bi-directional two wire bus that was developed by Philips for use in their televisions in the 1980s. The I2C API allows a developer to interface with an embedded system environment and transfer serial messages using the I2C protocols, allowing multiple simultaneous device control.

## Display



**Brightness Control**

The Brightness Control API allows a developer to interface with an embedded device to easily control brightness.



**Backlight**

The Backlight API allows a developer to control the backlight (screen) on/off in an embedded device.

## Monitor



**Watchdog**

A watchdog timer (WDT) is a device that performs a specific operation after a certain period of time if something goes wrong and the system does not recover on its own. A watchdog timer can be programmed to perform a warm boot (restarting the system) after a certain number of seconds.



**Hardware Monitor**

The Hardware Monitor (HWM) API is a system health supervision API that inspects certain condition indexes, such as fan speed, temperature and voltage.



**Hardware Control**

The Hardware Control API allows developers to set the PWM (Pulse Width Modulation) value to adjust fan speed or other devices; it can also be used to adjust the LCD brightness.

## Power Saving



**CPU Speed**

Make use of Intel SpeedStep technology to reduce power consumption. The system will automatically adjust the CPU Speed depending on system loading.



**System Throttling**

Refers to a series of methods for reducing power consumption in computers by lowering the clock frequency. These APIs allow the user to lower the clock from 87.5% to 12.5%.



# Appendix **A**

## Pin Assignment

This appendix gives you the information about the hardware pin assignment of the SOM-7567 CPU System on Module

Sections include:

- SOM-7567 Type 10 Pin Assignment

## A.1 SOM-7567 Type 10 Pin Assignment

This section gives SOM-7567 pin assignment on COM Express connector which compliant with COMR.0 R2.1 Type 10 pin-out definitions. More details about how to use these pins and get design reference, please contact Advantech for design guide, checklist, reference schematic, and other hardware/software supports.

(Advantech Design Support Website: [Http://com.advantech.com](http://com.advantech.com))

SOM-7567			
Row A,B			
A1	GND	B1	GND
A2	GBE0_MDI3-	B2	GBE0_ACT#
A3	GBE0_MDI3+	B3	LPC_FRAME#
A4	GBE0_LINK100#	B4	LPC_AD0
A5	GBE0_LINK1000#	B5	LPC_AD1
A6	GBE0_MDI2-	B6	LPC_AD2
A7	GBE0_MDI2+	B7	LPC_AD3
A8	GBE0_LINK#	B8	N/A
A9	GBE0_MDI1-	B9	N/A
A10	GBE0_MDI1+	B10	LPC_CLK
A11	GND	B11	GND
A12	GBE0_MDI0-	B12	PWRBTN#
A13	GBE0_MDI0+	B13	SMB_CK
A14	N/A	B14	SMB_DAT
A15	SUS_S3#	B15	SMB_ALERT#
A16	SATA0_TX+	B16	N/A (option SATA1_TX+)
A17	SATA0_TX-	B17	N/A (option SATA1_TX-)
A18	SUS_S4#	B18	SUS_STAT#
A19	SATA0_RX+	B19	N/A (option SATA1_RX+)
A20	SATA0_RX-	B20	N/A (option SATA1_RX-)
A21	GND	B21	GND
A22	USB_SSRX0-	B22	USB_SSTX0-
A23	USB_SSRX0+	B23	USB_SSTX0+
A24	SUS_S4#	B24	PWR_OK
A25	N/A	B25	N/A
A26	N/A	B26	N/A
A27	BATLOW#	B27	WDT
A28	SATA_ACT#	B28	N/A
A29	HDA_SYNC	B29	HDA_SDIN1
A30	HDA_RST#	B30	HDA_SDIN0
A31	GND	B31	GND
A32	HDA_BITCLK	B32	SPKR
A33	HDA_SDOUT	B33	I2C_CK
A34	BIOS_DIS0#	B34	I2C_DAT

A35	N/A	B35	THRM#
A36	N/A	B36	USB7- (Client)
A37	N/A	B37	USB7+ (Client)
A38	N/A	B38	N/A
A39	N/A	B39	N/A
A40	N/A	B40	N/A
A41	GND	B41	GND
A42	USB2-	B42	USB3-
A43	USB2+	B43	USB3+
A44	USB_2_3_OC#	B44	USB_0_1_OC#
A45	USB0-	B45	USB1-
A46	USB0+	B46	USB1+
A47	VCC_RTC	B47	EXCD1_PERST#
A48	EXCD0_PERST#	B48	EXCD1_CPPE#
A49	EXCD0_CPPE#	B49	SYS_RESET#
A50	LPC_SERIRQ	B50	CB_RESET#
A51	GND	B51	GND
A52	RSVD	B52	RSVD
A53	RSVD	B53	RSVD
A54	GPI0	B54	GPO1
A55	RSVD	B55	RSVD
A56	RSVD	B56	RSVD
A57	GND	B57	GPO2
A58	N/A (option PCIE_TX3+)	B58	N/A (option PCIE_RX3+)
A59	N/A (option PCIE_TX3-)	B59	N/A (option PCIE_RX3-)
A60	GND	B60	GND
A61	PCIE_TX2+	B61	PCIE_RX2+
A62	PCIE_TX2-	B62	PCIE_RX2-
A63	GPI1	B63	GPO3
A64	PCIE_TX1+	B64	PCIE_RX1+
A65	PCIE_TX1-	B65	PCIE_RX1-
A66	GND	B66	WAKE0#
A67	GPI2	B67	WAKE1#
A68	PCIE_TX0+	B68	PCIE_RX0+
A69	PCIE_TX0-	B69	PCIE_RX0-
A70	GND	B70	GND
A71	LVDS_A0+	B71	DDIO_PAIR0+
A72	LVDS_A0-	B72	DDIO_PAIR0-
A73	LVDS_A1+	B73	DDIO_PAIR1+
A74	LVDS_A1-	B74	DDIO_PAIR1-
A75	LVDS_A2+	B75	DDIO_PAIR2+
A76	LVDS_A2-	B76	DDIO_PAIR2-
A77	LVDS_VDD_EN	B77	N/A
A78	LVDS_A3+	B78	N/A
A79	LVDS_A3-	B79	LVDS_BKLT_EN
A80	GND	B80	GND

A81	LVDS_A_CK+	B81	DDIO_PAIR3+
A82	LVDS_A_CK-	B82	DDIO_PAIR3-
A83	LVDS_I2C_CK	B83	LVDS_BKLT_CTRL
A84	LVDS_I2C_DAT	B84	VCC_5V_SBY
A85	GPI3	B85	VCC_5V_SBY
A86	RSVD	B86	VCC_5V_SBY
A87	N/A	B87	VCC_5V_SBY
A88	PCIE0_CK_REF+	B88	BIOS_DIS1#
A89	PCIE0_CK_REF-	B89	DDIO_HPD
A90	GND	B90	GND
A91	SPI_POWER	B91	N/A
A92	SPI_MISO	B92	N/A
A93	GPO0	B93	N/A
A94	SPI_CLK	B94	N/A
A95	SPI_MOSI	B95	DDIO_DDC_AUX_SEL
A96	PP_TPM	B96	RSVD
A97	TYPE10#	B97	SPI_CS#
A98	RS1_TX	B98	DDIO_CTRLCLK_AUX+
A99	RS1_RX	B99	DDIO_CTRLDATA_AUX-
A100	GND	B100	GND
A101	RS2_TX	B101	FAN_PWMOUT
A102	RS2_RX	B102	FAN_TACHIN
A103	LID#	B103	SLEEP#
A104	VCC_12V	B104	VCC_12V
A105	VCC_12V	B105	VCC_12V
A106	VCC_12V	B106	VCC_12V
A107	VCC_12V	B107	VCC_12V
A108	VCC_12V	B108	VCC_12V
A109	VCC_12V	B109	VCC_12V
A110	GND	B110	GND

# Appendix **B**

## Watchdog Timer

This appendix gives you the information about the watchdog timer programming on the SOM-7567 CPU System on Module

Sections include:

- Watchdog Timer Programming

---

## B.1 Programming the Watchdog Timer

Trigger Event	Note
IRQ	IRQ5, 7, 14 (BIOS setting default disable)**
NMI	N/A
SCI	Power button event
Power Off	Support
H/W Restart	Support
External WDT	N/A

\*\* WDT new driver support automatically select available IRQ number from BIOS, and then set to EC. Only Win7 and Win8 support it.

In other OS, it will still use IRQ number from BIOS setting as usual.

For details, please refer to iManager & Software API User Manual:



# Appendix **C**

## Programming GPIO

This Appendix gives the illustration of the General Purpose Input and Output pin setting.

Sections include:

- System I/O ports

---

## C.1 GPIO Register

<b>GPIO Byte Mapping</b>	<b>H/W Pin Name</b>
BIT0	GPO0
BIT1	GPO1
BIT2	GPO2
BIT3	GPO3
BIT4	GPI0
BIT5	GPI1
BIT6	GPI2
BIT7	GPI3

For details, please refer to iManager & Software API User Manual

# Appendix **D**

## System Assignments

This appendix gives you the information about the system resource allocation on the SOM-7567 CPU System on Module

Sections include:

- System I/O ports
- DMA Channel Assignments
- Interrupt Assignments
- 1st MB Memory Map

## D.1 System I/O Ports

**Table D.1: System I/O ports**

<b>Addr.range(Hex)</b>	<b>Device</b>
0060-0060	Standard PS/2 Keyboard
0064-0064	Standard PS/2 Keyboard
0020-0021	Programmable interrupt controller
0024-0025	Programmable interrupt controller
0028-0029	Programmable interrupt controller
002C-002D	Programmable interrupt controller
0030-0031	Programmable interrupt controller
0034-0035	Programmable interrupt controller
0038-0039	Programmable interrupt controller
003C-003D	Programmable interrupt controller
00A0-00A1	Programmable interrupt controller
00A4-00A5	Programmable interrupt controller
00A8-00A9	Programmable interrupt controller
00AC-00AD	Programmable interrupt controller
00B0-00B1	Programmable interrupt controller
00B4-00B5	Programmable interrupt controller
00B8-00B9	Programmable interrupt controller
00BC-00BD	Programmable interrupt controller
04D0-04D1	Programmable interrupt controller
0040-0043	System timer
0050-0053	System timer
0378-037F	Printer Port (LPT1)
0778-077F	Printer Port (LPT1)
03F8-03FF	Communications Port (COM1)
E070-E077	Intel(R) Pentium(R) processor N- and J-series / Intel(R) Celeron(R) processor N- and J-series AHCI - 0F23
E060-E063	Intel(R) Pentium(R) processor N- and J-series / Intel(R) Celeron(R) processor N- and J-series AHCI - 0F23
E050-E057	Intel(R) Pentium(R) processor N- and J-series / Intel(R) Celeron(R) processor N- and J-series AHCI - 0F23
E040-E043	Intel(R) Pentium(R) processor N- and J-series / Intel(R) Celeron(R) processor N- and J-series AHCI - 0F23
E020-E03F	Intel(R) Pentium(R) processor N- and J-series / Intel(R) Celeron(R) processor N- and J-series AHCI - 0F23
02F8-02FF	Communications Port (COM2)
03E8-03EF	Communications Port (COM3)
02E8-02EF	Communications Port (COM4)
0000-006F	PCI bus
0078-0CF7	PCI bus
0D00-FFFF	PCI bus
0070-0077	System CMOS/real time clock
0070-0077	Motherboard resources
0A00-0A0F	Motherboard resources
0A10-0A1F	Motherboard resources

**Table D.1: System I/O ports**

E000-E01F	Intel(R) Pentium(R) processor N- and J-series / Intel(R) Celeron(R) processor N- and J-series Platform Control Unit - SMBus Port - 0F12
E080-E087	Intel(R) Atom(TM) Processor E3800 Series/Intel(R) Celeron(R) Processor N2920/J1900
03B0-03BB	Intel(R) Atom(TM) Processor E3800 Series/Intel(R) Celeron(R) Processor N2920/J1900
03C0-03DF	Intel(R) Atom(TM) Processor E3800 Series/Intel(R) Celeron(R) Processor N2920/J1900
002E-002F	Motherboard resources
004E-004F	Motherboard resources
0061-0061	Motherboard resources
0063-0063	Motherboard resources
0065-0065	Motherboard resources
0067-0067	Motherboard resources
0080-008F	Motherboard resources
0092-0092	Motherboard resources
00B2-00B3	Motherboard resources
0680-069F	Motherboard resources
0400-047F	Motherboard resources
0500-05FE	Motherboard resources
0600-061F	Motherboard resources
029C-029D	Motherboard resources
0062-0062	Microsoft ACPI-Compliant Embedded Controller
0066-0066	Microsoft ACPI-Compliant Embedded Controller
D000-DFFF	Intel(R) Pentium(R) processor N- and J-series / Intel(R) Celeron(R) processor N- and J-series PCI Express - Root Port 4 - 0F4E

## D.2 DMA Channel Assignments

**Table D.2: DMA channel assignments**

Channel	Function
3	ECP Printer Port (LPT1)

## D.3 Interrupt Assignments

**Table D.3: Interrupt assignments**

<b>Interrupt#</b>	<b>Interrupt source</b>
NMI	Parity error detected
IRQ 0	System timer
IRQ 1	Standard PS/2 Keyboard
IRQ 3	Communications Port (COM2)
IRQ 4	Communications Port (COM1)
IRQ 6	Communications Port (COM4)
IRQ 8	High precision event timer
IRQ 10	Intel(R) Pentium(R) processor N- and J-series / Intel(R) Celeron(R) processor N- and J-series Platform Control Unit - SMBus Port - 0F12
IRQ 11	Communications Port (COM3)
IRQ 12	PS/2 Compatible Mouse
IRQ 16	Intel(R) Pentium(R) processor N- and J-series / Intel(R) Celeron(R) processor N- and J-series PCI Express - Root Port 1 - 0F48
IRQ 17	Intel(R) Pentium(R) processor N- and J-series / Intel(R) Celeron(R) processor N- and J-series PCI Express - Root Port 2 - 0F4A
IRQ 18	Intel(R) Pentium(R) processor N- and J-series / Intel(R) Celeron(R) processor N- and J-series PCI Express - Root Port 3 - 0F4C
IRQ 19	Intel(R) Pentium(R) processor N- and J-series / Intel(R) Celeron(R) processor N- and J-series AHCI - 0F23
IRQ 19	Intel(R) Pentium(R) processor N- and J-series / Intel(R) Celeron(R) processor N- and J-series PCI Express - Root Port 4 - 0F4E
IRQ 22	High Definition Audio Controller
IRQ 23	Intel(R) Pentium(R) processor N- and J-series / Intel(R) Celeron(R) processor N- and J-series EHCI USB - 0F34

## D.4 1st MB Memory Map

**Table D.4: 1st MB memory map**

<b>Addr. range (Hex)</b>	<b>Device</b>
B0700000-B07FFFFFFF	Intel(R) I210 Gigabit Network Connection
B0800000-B0803FFF	Intel(R) I210 Gigabit Network Connection
FED00000-FED003FF	High precision event timer
B0900000-B0903FFF	High Definition Audio Controller
B0906000-B09067FF	Intel(R) Pentium(R) processor N- and J-series / Intel(R) Celeron(R) processor N- and J-series AHCI - 0F23
000A0000-000BFFFF	PCI bus
000A0000-000BFFFF	Intel(R) Atom(TM) Processor E3800 Series/Intel(R) Celeron(R) Processor N2920/J1900
000C0000-000DFFFF	PCI bus
000E0000-000FFFFFFF	PCI bus
A0000000-B0906FFE	PCI bus
A0000000-B0906FFE	Intel(R) Atom(TM) Processor E3800 Series/Intel(R) Celeron(R) Processor N2920/J1900
B0904000-B090401F	Intel(R) Pentium(R) processor N- and J-series / Intel(R) Celeron(R) processor N- and J-series Platform Control Unit - SMBus Port - 0F12
B0000000-B03FFFFFFF	Intel(R) Atom(TM) Processor E3800 Series/Intel(R) Celeron(R) Processor N2920/J1900
E0000000-EFFFFFFF	Motherboard resources
FED01000-FED01FFF	Motherboard resources
FED03000-FED03FFF	Motherboard resources
FED04000-FED04FFF	Motherboard resources
FED08000-FED08FFF	Motherboard resources
FED1C000-FED1CFFF	Motherboard resources
FEE00000-FEEFFFFFFF	Motherboard resources
FEF00000-FEFFFFFFF	Motherboard resources
B0500000-B05FFFFFFF	Intel(R) Trusted Execution Engine Interface
B0400000-B04FFFFFFF	Intel(R) Trusted Execution Engine Interface
B0905000-B09053FF	Intel(R) Pentium(R) processor N- and J-series / Intel(R) Celeron(R) processor N- and J-series EHCI USB - 0F34
B0600000-B08FFFFFFF	Intel(R) Pentium(R) processor N- and J-series / Intel(R) Celeron(R) processor N- and J-series PCI Express - Root Port 4 - 0F4E
FF000000-FFFFFFFF	Intel(R) 82802 Firmware Hub Device

**ADVANTECH**

*Enabling an Intelligent Planet*

**[www.advantech.com](http://www.advantech.com)**

Please verify specifications before quoting. This guide is intended for reference purposes only.

All product specifications are subject to change without notice.

No part of this publication may be reproduced in any form or by any means, electronic, photocopying, recording or otherwise, without prior written permission of the publisher.

All brand and product names are trademarks or registered trademarks of their respective companies.

© Advantech Co., Ltd. 2014