

1 2 3 4 5 6

A

B

C

D

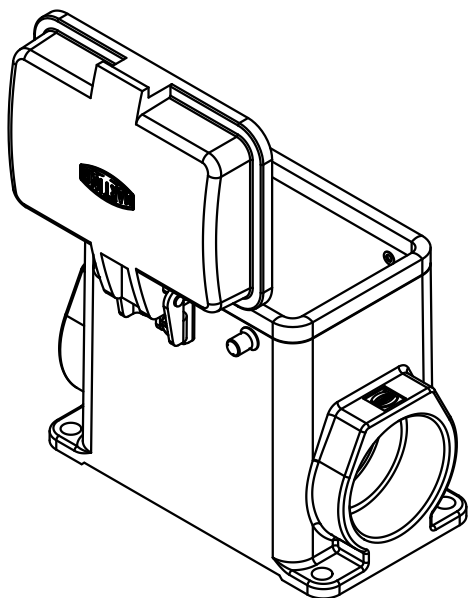
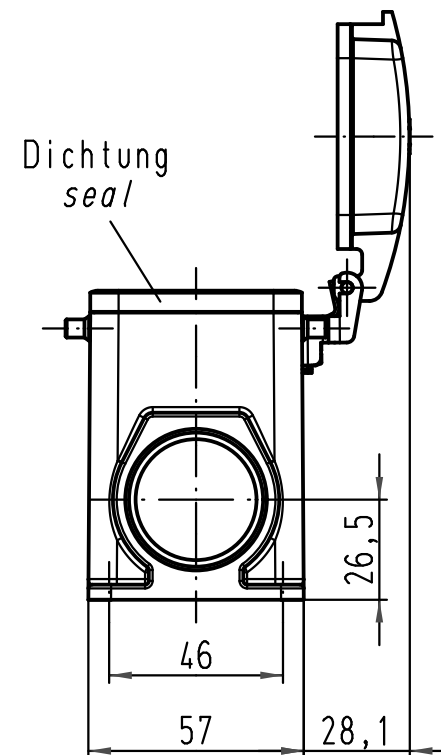
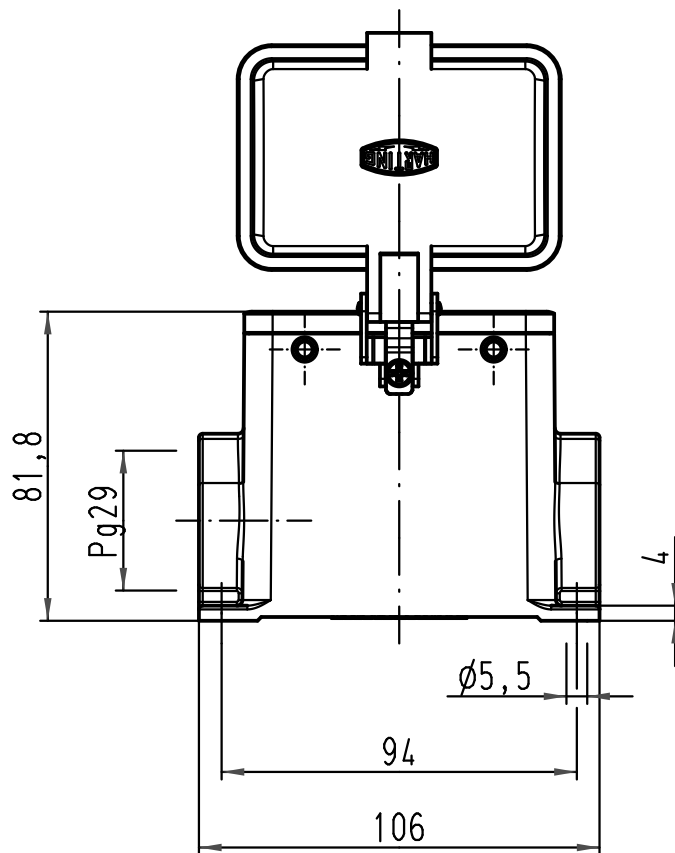

All Dimensions in mm Original Size DIN A 4		Techn. Character.			Nicht tolerierte Maß/Free size tolerances		
			Dat.	Name	Maßstab/Scale  1:2	Han 32A-asg1-K-29 Sockelgehäuse housing surface mounting	
			Detail.	26.01.11 Spr			
			Insp.	Be			
			Stand.				
A			HARTING Electric GmbH & Co. KG D-32339 Espelkamp				TB 09 20 032 0221
Mod.	Dat.	Name					
						Blatt/page	