

UV Light Meter

Model UV510

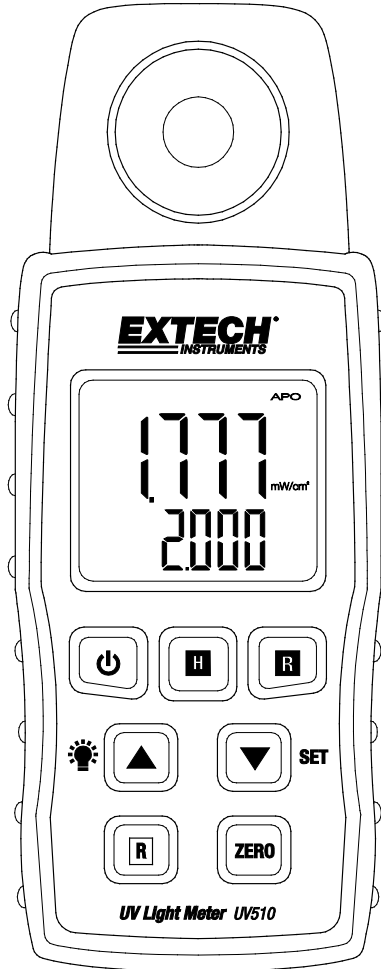

Introduction

Thank you for selecting the Extech Model UV510 UV Light Meter. This device measures UVA ultraviolet light between 320-390nm. This device is shipped fully tested and calibrated and, with proper use, will provide years of reliable service. Please visit our website (www.extech.com) to check for the latest version and translations of this User Manual, Product Updates, Product Registration, and Customer Support.

Features

- UV sensor with cosine correction filter
- Long wave 365nm ultraviolet irradiance measurements (UVA)
- Lightweight, ergonomic design

Safety

Please read the entire User Manual and Quick Start before operating this device. Use the meter only as specified and do not attempt to service or open the meter housing. Do not allow children to handle the meter or the protective cover. Please dispose of batteries and meter responsibly and in accordance with all applicable laws and regulations.

UV Safety Information

Use extreme caution when using this meter to test an ultraviolet light source. Exposure to UV radiation can be hazardous depending on the exposure time, intensity of radiation, wavelength and an individual's sensitivity to ultraviolet.

Meter Description

1. Light Sensor
2. LCD Display
3. ON-OFF button
4. LCD Backlight button and ▲ button
5. Range button
6. Zero button
7. SET and ▼ button
8. Record button (max/min)
9. Hold button
10. Light sensor cover

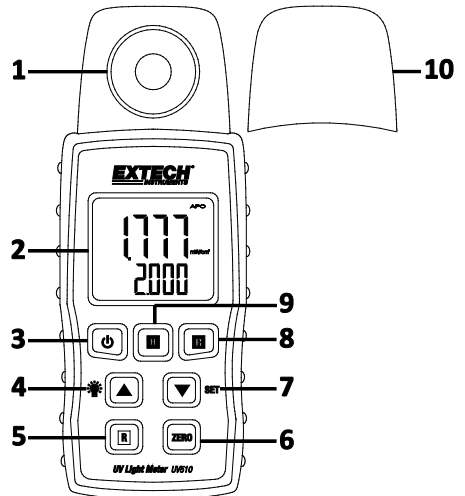

Note: Battery compartment and tripod mount on rear of meter

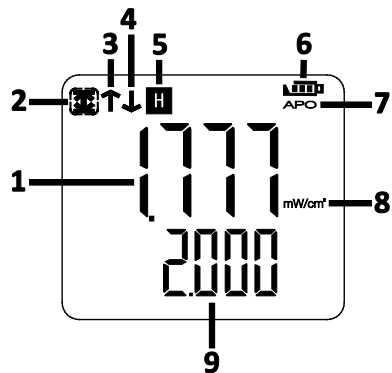

LCD Description

1. Primary Display
2. MAX/MIN Record Icon
3. MAX Icon
4. MIN Icon
5. Display Hold Icon
6. Battery Indicator
7. Auto Power OFF
8. Unit of measure (mW/cm²)
9. Selected Range Display



Operation

Taking a Measurement

1. Short press the  power button. If the LCD does not switch on, check the batteries located in the rear battery compartment.
2. With the sensor cover attached to the meter, short press the zero button, to zero the display, before taking any measurements.
3. Remove the sensor cover.
4. Aim the light sensor at the UV light source.
5. View the measurement on the meter's display.
6. Use the Range **R** button to select the best range for the measurement.
7. To power OFF the meter, short press the  button.

Power ON/OFF

Short press the  button to power on the meter. Short press again to power OFF.

Range Selection

Short press the range button to toggle the range (2.000mW/cm² and 20.00mW/cm²); the lower display will show the selected range.

Zero Function

To zero the display, place the protective light cover over the UV sensor and press the **ZERO** button.

Data Hold



Short press the **H** (hold) button to freeze or unfreeze a reading on the display. Hold function is not operational while in record mode.

Backlight

The LCD is equipped with backlighting for easier viewing, especially in dimly lit areas. Short press the  backlight button to power ON the backlight. The backlight will automatically power off after 10 seconds.

MAX-MIN Recording

In this mode, the meter records the maximum and minimum values over time.



1. Press the **R** (record) button to enter the Record mode. The  record icon will appear on the display. The maximum and minimum values will be recorded and updated during the measurement period.
2. Press the **R** (record) button again to display the maximum value recorded. The  icon will appear on the display.

3. Press the **R** (record) button again to display the minimum value recorded. The  icon will appear on the display.
4. Press the **H** (hold) button to clear the recorded data. The previous data will be erased and the meter will start recording new data.
5. Long press the **R** (record) button to exit the record mode.

Auto Power OFF (APO)

In order to conserve battery life, the meter will automatically shut off after approximately 10 minutes of inactivity. The APO icon appears in the display (upper right) when APO is selected.

To set APO ON or OFF as the default condition:

1. Long press the **SET** button. The lower display will show 'PoFF'.
2. Short press the  or  button to enable APO (YES) or disable APO (NO) as shown in the upper display.
3. Short press the **R** (record) button to save the selection.
4. The meter will return to normal operating mode after approximately 10 seconds.

Note: APO is not operational in record mode.

Maintenance

Battery Replacement

1. Power OFF the meter.
2. Remove the flat head screw that secures the battery compartment at the back of the meter.
3. Open the battery compartment and replace the 3 'AAA' 1.5V batteries observing correct polarity. Re-assemble the meter before use

Safety: Please dispose of batteries responsibly; never dispose of batteries in a fire, batteries may explode or leak. If the meter is not to be used for 60 days or more, remove the battery and store separately.



Never dispose of used batteries or rechargeable batteries in household waste.

As consumers, users are legally required to take used batteries to appropriate collection sites, the retail store where the batteries were purchased, or wherever batteries are sold.

Disposal: Do not dispose of this instrument in household waste. The user is obligated to take end-of-life devices to a designated collection point for the disposal of electrical and electronic equipment.

Cleaning and Storage

Periodically wipe the case with a damp cloth and mild detergent; do not use abrasives or solvents.

Specifications

Display	Backlit LCD 35 x 30mm (1.4 x 1.2")		
Light sensor	Photo sensor with cosine correction filter		
Measurements	Ultraviolet Light (UVA)		
UV sensor spectrum	320 to 390 nm		
Input Overload Display	"----"		
Tripod mount	On rear panel		
Power	3 x 1.5V 'AAA' batteries		
Power Consumption	Approx. 5mA DC		
Automatic power off	After approx. 10 minutes of inactivity		
Operating temperature	0 to 50°C (32 to 122°F)		
Operating humidity	80% RH max		
Dimensions/Weight	141 x 58 x 25mm (5.5 x 2.3 x 1.0") /160g (5.64oz)		
Electrical Specifications (23±5°C)			
Ultraviolet (UVA)			
Unit	Range	Resolution	Accuracy
mW/cm ²	0 to 1.999	0.001	±(4% FS + 2dgt)
	2 to 20.00	0.01	

Copyright © 2017 FLIR Systems, Inc.

All rights reserved including the right of reproduction in whole or in part in any form

ISO-9001 Certified

www.extech.com