

# NTNS3A65PZ

## Small Signal MOSFET

-20 V, -281 mA, Single P-Channel,  
SOT-883 (XDFN3) 1.0 x 0.6 x 0.4 mm  
Package

### Features

- Single P-Channel MOSFET
- Ultra Low Profile SOT-883 (XDFN3) 1.0 x 0.6 x 0.4 mm for Extremely Thin Environments Such as Portable Electronics
- Low  $R_{DS(on)}$  Solution in the Ultra Small 1.0 x 0.6 mm Package
- 1.5 V Gate Drive
- These Devices are Pb-Free, Halogen Free/BFR Free and are RoHS Compliant

### Applications

- High Side Switch
- High Speed Interfacing
- Optimized for Power Management in Ultra Portable Solutions

### MAXIMUM RATINGS ( $T_J = 25^\circ\text{C}$ unless otherwise stated)

Parameter		Symbol	Value	Unit	
Drain-to-Source Voltage		$V_{DSS}$	-20	V	
Gate-to-Source Voltage		$V_{GS}$	$\pm 8$	V	
Continuous Drain Current (Note 1)	Steady State	$I_D$	$T_A = 25^\circ\text{C}$	-281	mA
			$T_A = 85^\circ\text{C}$	-202	
	$t \leq 5$ s	$T_A = 25^\circ\text{C}$	-332		
Power Dissipation (Note 1)	Steady State	$P_D$	$T_A = 25^\circ\text{C}$	155	mW
	$t \leq 5$ s			218	
Pulsed Drain Current	$t_p = 10$ $\mu\text{s}$	$I_{DM}$	-842	mA	
Operating Junction and Storage Temperature		$T_J, T_{STG}$	-55 to 150	$^\circ\text{C}$	
Source Current (Body Diode) (Note 2)		$I_S$	-130	mA	
Lead Temperature for Soldering Purposes (1/8" from case for 10 s)		$T_L$	260	$^\circ\text{C}$	

Stresses exceeding Maximum Ratings may damage the device. Maximum Ratings are stress ratings only. Functional operation above the Recommended Operating Conditions is not implied. Extended exposure to stresses above the Recommended Operating Conditions may affect device reliability.

1. Surface-mounted on FR4 board using the minimum recommended pad size, or 2 mm<sup>2</sup>, 1 oz Cu.
2. Pulse Test: pulse width  $\leq 300$   $\mu\text{s}$ , duty cycle  $\leq 2\%$



ON Semiconductor®

<http://onsemi.com>

$V_{(BR)DSS}$	$R_{DS(on)}$ MAX	$I_D$ Max
-20 V	1.3 $\Omega$ @ -4.5 V	-281 mA
	2.0 $\Omega$ @ -2.5 V	
	3.4 $\Omega$ @ -1.8 V	
	4.5 $\Omega$ @ -1.5 V	

### P-CHANNEL MOSFET

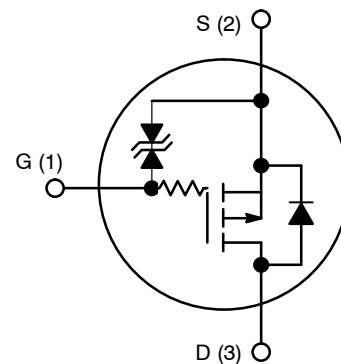

### MARKING DIAGRAM



SOT-883 (XDFN3)  
CASE 506CB

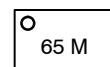

65 = Specific Device Code  
M = Date Code

### ORDERING INFORMATION

Device	Package	Shipping†
NTNS3A65PZT5G	SOT-883 (Pb-Free)	8000 / Tape & Reel

†For information on tape and reel specifications, including part orientation and tape sizes, please refer to our Tape and Reel Packaging Specification Brochure, BRD8011/D.

# NTNS3A65PZ

## THERMAL RESISTANCE RATINGS

Parameter	Symbol	Max	Unit
Junction-to-Ambient – Steady State (Note 3)	$R_{\theta JA}$	804	°C/W
Junction-to-Ambient – $t \leq 5$ s (Note 3)	$R_{\theta JA}$	574	

3. Surface-mounted on FR4 board using the minimum recommended pad size, or 2 mm<sup>2</sup>, 1 oz Cu.

## ELECTRICAL CHARACTERISTICS ( $T_J = 25^\circ\text{C}$ unless otherwise stated)

Parameter	Symbol	Test Condition	Min	Typ	Max	Unit
-----------	--------	----------------	-----	-----	-----	------

### OFF CHARACTERISTICS

Drain-to-Source Breakdown Voltage	$V_{(BR)DSS}$	$V_{GS} = 0$ V, $I_D = -250$ $\mu$ A	-20			V
Drain-to-Source Breakdown Voltage Temperature Coefficient	$V_{(BR)DSS}/T_J$	$I_D = -250$ $\mu$ A, ref to 25°C		11		mV/°C
Zero Gate Voltage Drain Current	$I_{DSS}$	$V_{GS} = 0$ V, $V_{DS} = -20$ V, $T_J = 25^\circ\text{C}$			-1	$\mu$ A
Gate-to-Source Leakage Current	$I_{GSS}$	$V_{DS} = 0$ V, $V_{GS} = \pm 5$ V			$\pm 10$	$\mu$ A

### ON CHARACTERISTICS (Note 4)

Gate Threshold Voltage	$V_{GS(TH)}$	$V_{GS} = V_{DS}$ , $I_D = -250$ $\mu$ A	-0.4		-1.0	V
Negative Threshold Temperature Coefficient	$V_{GS(TH)}/T_J$			2.2		mV/°C
Drain-to-Source On Resistance	$R_{DS(on)}$	$V_{GS} = -4.5$ V, $I_D = -200$ mA		0.9	1.3	$\Omega$
		$V_{GS} = -2.5$ V, $I_D = -100$ mA		1.3	2.0	
		$V_{GS} = -1.8$ V, $I_D = -50$ mA		1.8	3.4	
		$V_{GS} = -1.5$ V, $I_D = -10$ mA		2.3	4.5	$\Omega$
Forward Transconductance	$g_{FS}$	$V_{DS} = -5$ V, $I_D = -200$ mA		0.58		S
Source-Drain Diode Voltage	$V_{SD}$	$V_{GS} = 0$ V, $I_S = -100$ mA		-0.8	-1.2	V

### CHARGES & CAPACITANCES

Input Capacitance	$C_{ISS}$	$V_{GS} = 0$ V, freq = 1 MHz, $V_{DS} = -10$ V		44		pF
Output Capacitance	$C_{OSS}$			6.7		
Reverse Transfer Capacitance	$C_{RSS}$			5.5		
Total Gate Charge	$Q_{G(TOT)}$	$V_{GS} = -4.5$ V, $V_{DS} = -10$ V; $I_D = -200$ mA		1.1		nC
Threshold Gate Charge	$Q_{G(TH)}$			0.1		
Gate-to-Source Charge	$Q_{GS}$			0.2		
Gate-to-Drain Charge	$Q_{GD}$			0.2		

### SWITCHING CHARACTERISTICS, $V_{GS} = 4.5$ V (Note 4)

Turn-On Delay Time	$t_{d(ON)}$	$V_{GS} = -4.5$ V, $V_{DD} = -10$ V, $I_D = -200$ mA, $R_G = 2$ $\Omega$		18		ns
Rise Time	$t_r$			32		
Turn-Off Delay Time	$t_{d(OFF)}$			178		
Fall Time	$t_f$			84		

4. Switching characteristics are independent of operating junction temperatures

# NTNS3A65PZ

## TYPICAL CHARACTERISTICS

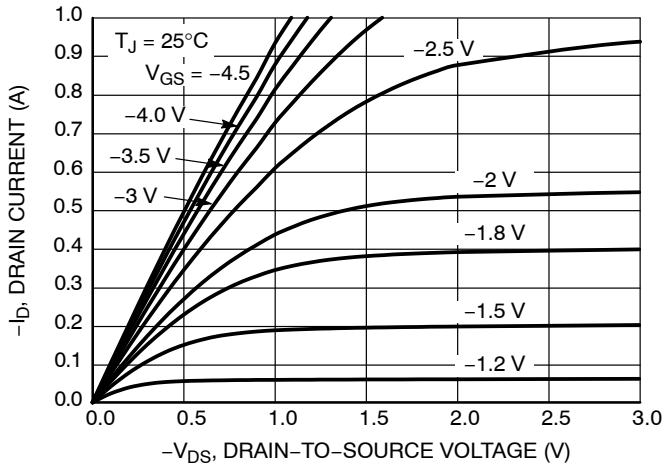

Figure 1. On-Region Characteristics

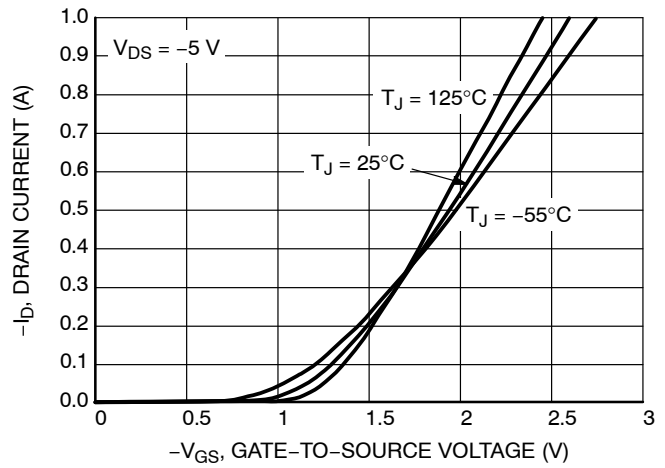

Figure 2. Transfer Characteristics

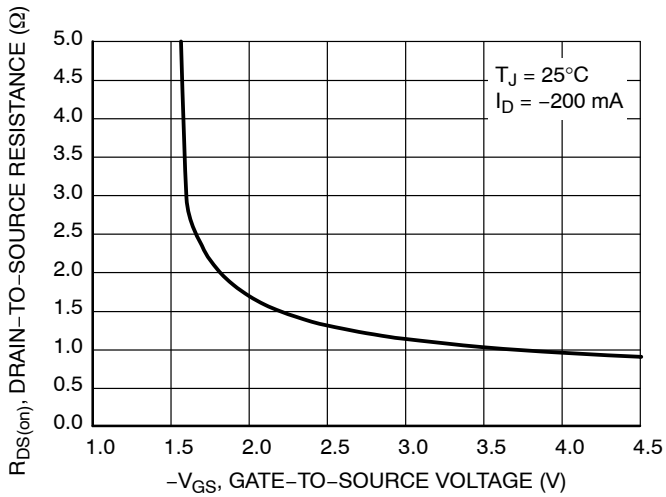

Figure 3. On-Resistance vs. Gate Voltage

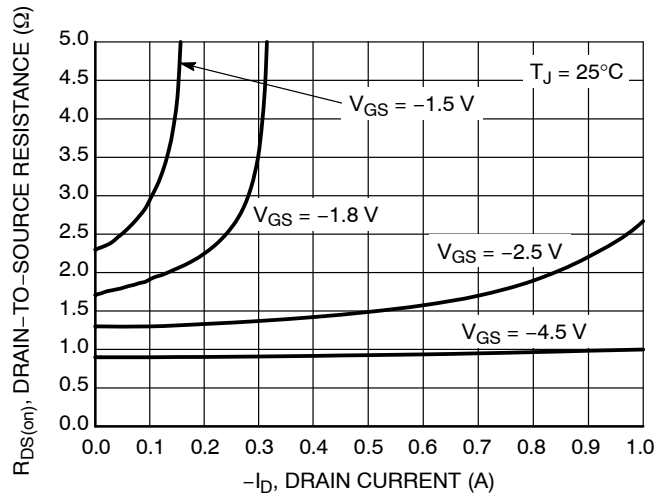

Figure 4. On-Resistance vs. Drain Current and Gate Voltage

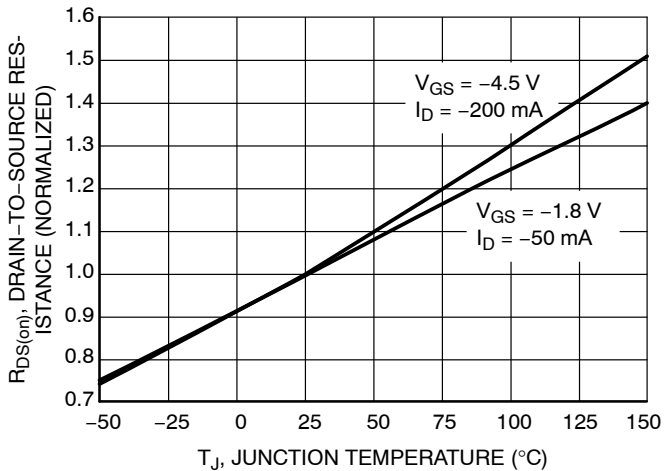

Figure 5. On-Resistance Variation with Temperature

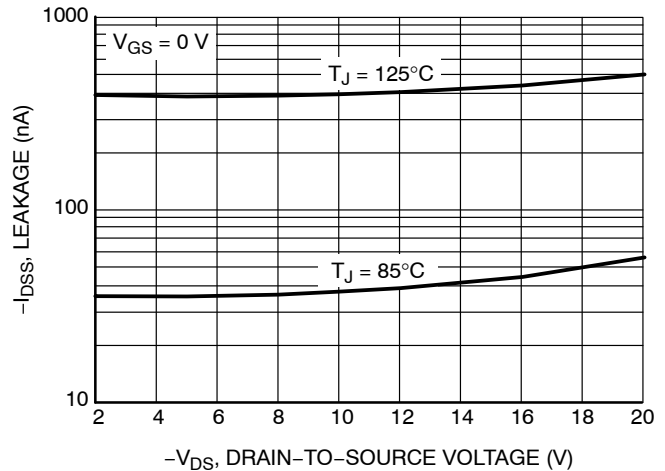

Figure 6. Drain-to-Source Leakage Current vs. Voltage

# NTNS3A65PZ

## TYPICAL CHARACTERISTICS

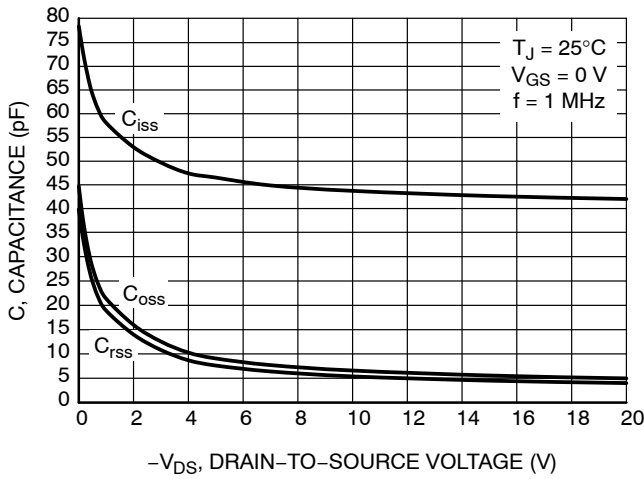

Figure 7. Capacitance Variation

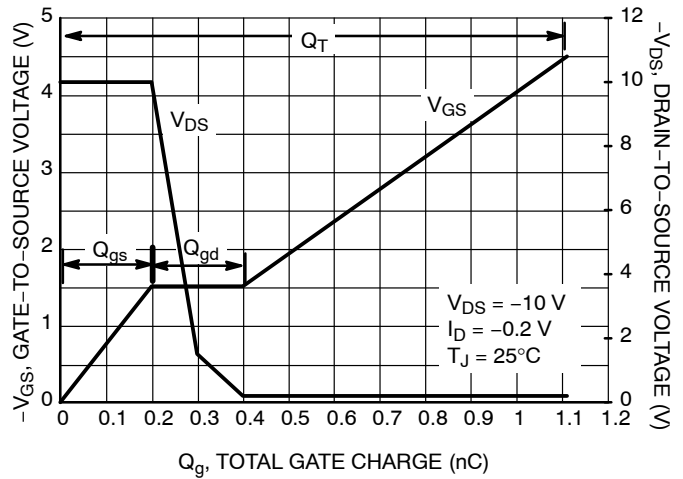

Figure 8. Gate-to-Source Voltage vs. Total Charge

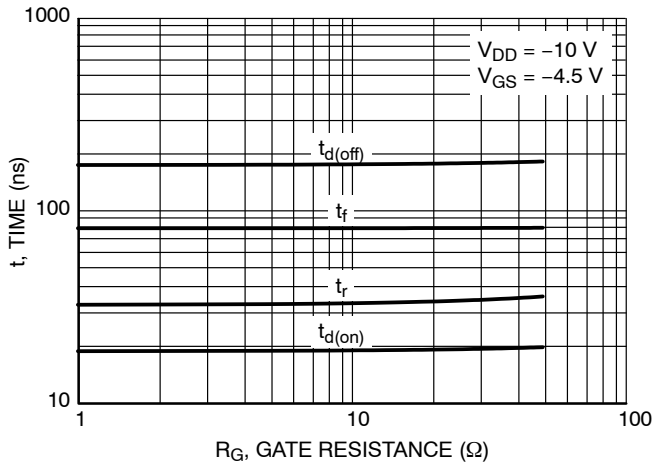

Figure 9. Resistive Switching Time Variation vs. Gate Resistance

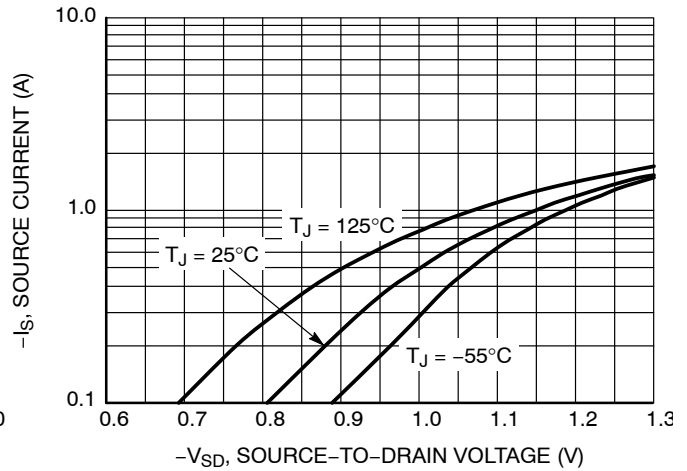

Figure 10. Diode Forward Voltage vs. Current

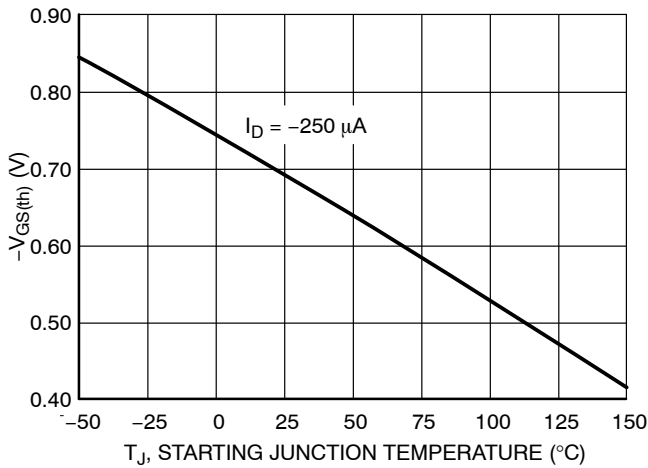

Figure 11. Threshold Voltage

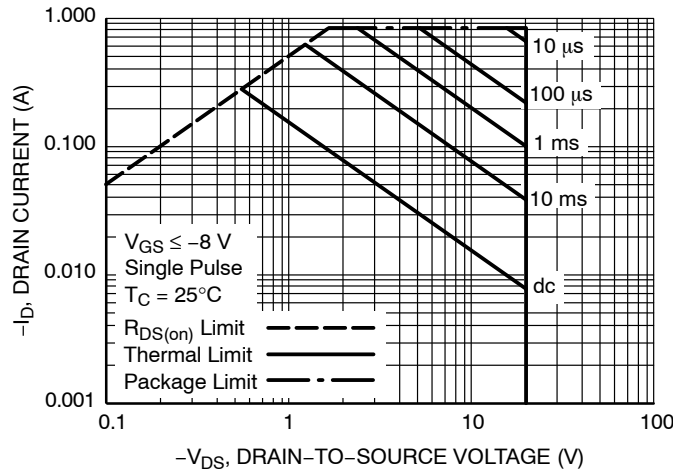

Figure 12. Maximum Rated Forward Biased Safe Operating Area

# NTNS3A65PZ

## TYPICAL CHARACTERISTICS

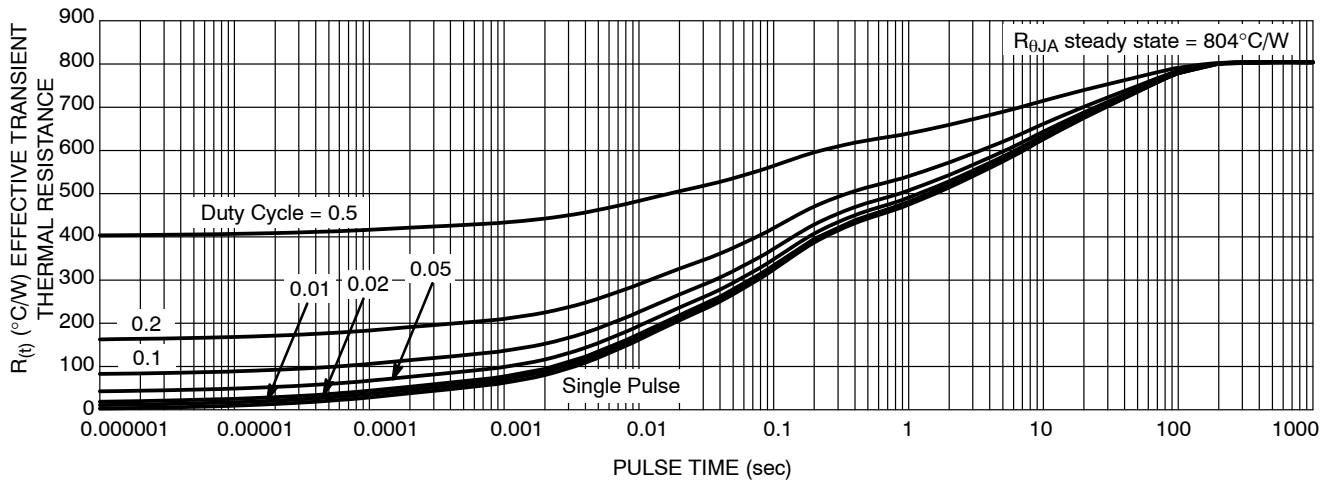
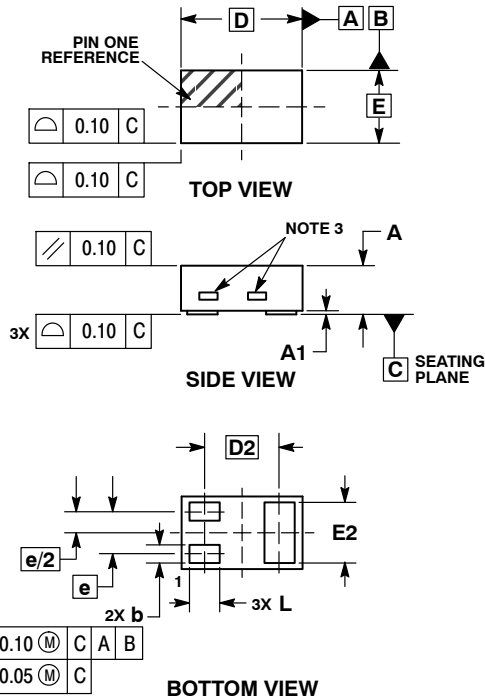

Figure 13. Thermal Response

# NTNS3A65PZ

## PACKAGE DIMENSIONS

SOT-883 (XDFN3), 1.0x0.6, 0.35P  
CASE 506CB  
ISSUE A



**NOTES:**

1. DIMENSIONING AND TOLERANCING PER ASME Y14.5M, 1994.
2. CONTROLLING DIMENSION: MILLIMETERS.
3. EXPOSED COPPER ALLOWED AS SHOWN.

MILLIMETERS		
DIM	MIN	MAX
A	0.340	0.440
A1	0.000	0.030
b	0.075	0.200
D	0.950	1.075
D2	0.620 BSC	
e	0.350 BSC	
E	0.550	0.675
E2	0.425	0.550
L	0.170	0.300

**RECOMMENDED SOLDER FOOTPRINT\***

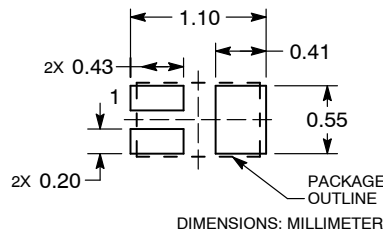

DIMENSIONS: MILLIMETERS

\*For additional information on our Pb-Free strategy and soldering details, please download the ON Semiconductor Soldering and Mounting Techniques Reference Manual, SOLDERRM/D.

ON Semiconductor and are registered trademarks of Semiconductor Components Industries, LLC (SCILLC). SCILLC owns the rights to a number of patents, trademarks, copyrights, trade secrets, and other intellectual property. A listing of SCILLC's product/patent coverage may be accessed at [www.onsemi.com/site/pdf/Patent-Marking.pdf](http://www.onsemi.com/site/pdf/Patent-Marking.pdf). SCILLC reserves the right to make changes without further notice to any products herein. SCILLC makes no warranty, representation or guarantee regarding the suitability of its products for any particular purpose, nor does SCILLC assume any liability arising out of the application or use of any product or circuit, and specifically disclaims any and all liability, including without limitation special, consequential or incidental damages. "Typical" parameters which may be provided in SCILLC data sheets and/or specifications can and do vary in different applications and actual performance may vary over time. All operating parameters, including "Typicals" must be validated for each customer application by customer's technical experts. SCILLC does not convey any license under its patent rights nor the rights of others. SCILLC products are not designed, intended, or authorized for use as components in systems intended for surgical implant into the body, or other applications intended to support or sustain life, or for any other application in which the failure of the SCILLC product could create a situation where personal injury or death may occur. Should Buyer purchase or use SCILLC products for any such unintended or unauthorized application, Buyer shall indemnify and hold SCILLC and its officers, employees, subsidiaries, affiliates, and distributors harmless against all claims, costs, damages, and expenses, and reasonable attorney fees arising out of, directly or indirectly, any claim of personal injury or death associated with such unintended or unauthorized use, even if such claim alleges that SCILLC was negligent regarding the design or manufacture of the part. SCILLC is an Equal Opportunity/Affirmative Action Employer. This literature is subject to all applicable copyright laws and is not for resale in any manner.

**PUBLICATION ORDERING INFORMATION**

**LITERATURE FULFILLMENT:**  
Literature Distribution Center for ON Semiconductor  
P.O. Box 5163, Denver, Colorado 80217 USA  
**Phone:** 303-675-2175 or 800-344-3860 Toll Free USA/Canada  
**Fax:** 303-675-2176 or 800-344-3867 Toll Free USA/Canada  
**Email:** [orderlit@onsemi.com](mailto:orderlit@onsemi.com)

**N. American Technical Support:** 800-282-9855 Toll Free  
USA/Canada  
**Europe, Middle East and Africa Technical Support:**  
Phone: 421 33 790 2910  
**Japan Customer Focus Center**  
Phone: 81-3-5817-1050

**ON Semiconductor Website:** [www.onsemi.com](http://www.onsemi.com)  
**Order Literature:** <http://www.onsemi.com/orderlit>  
For additional information, please contact your local Sales Representative