

# USER GUIDE

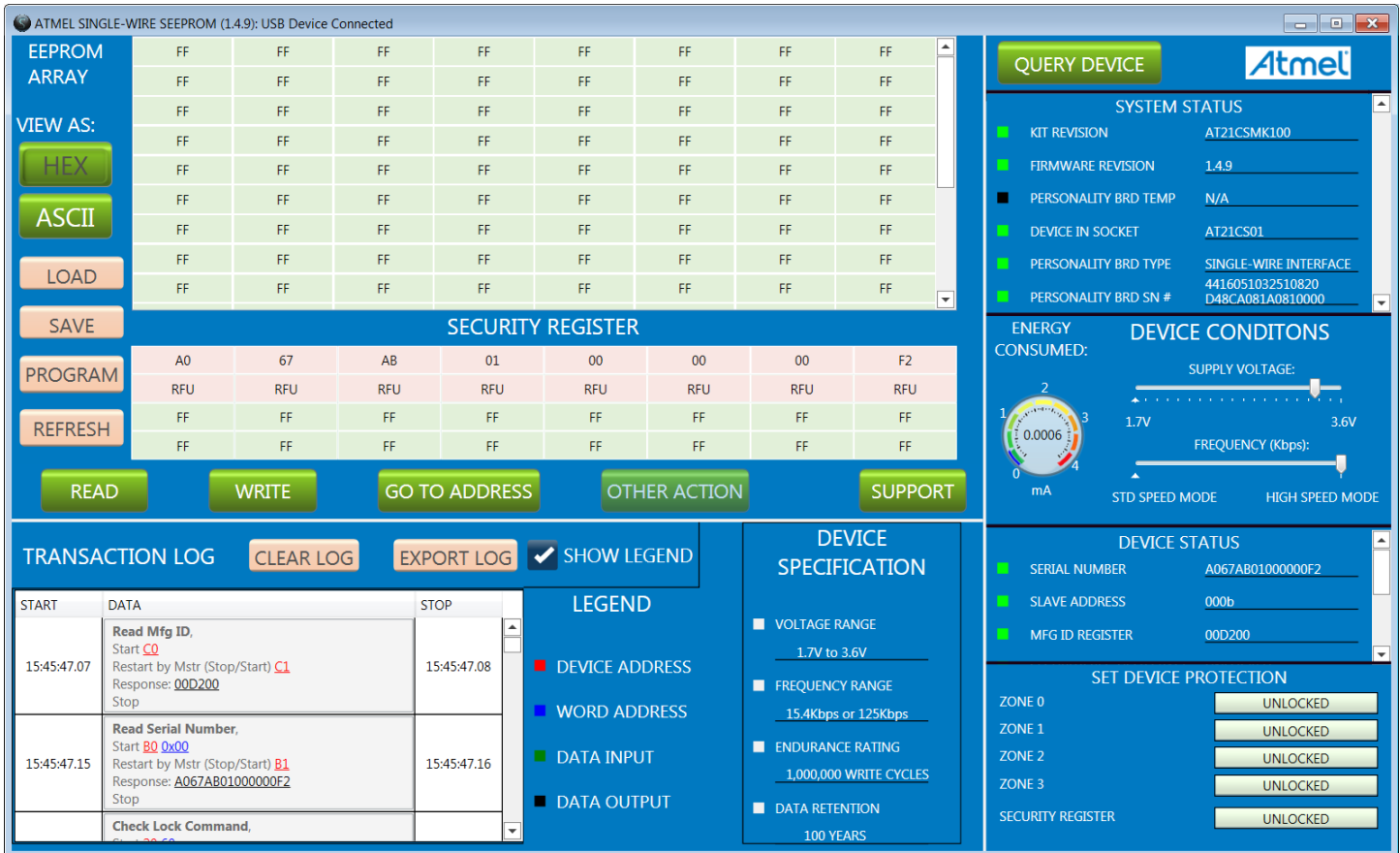

**Figure 1. Single-Wire Graphical User Interface**

## Introduction









The Atmel® AT21CSMK100 Single-Wire Serial EEPROM Evaluation Kit is an easy-to-use interactive tool to demonstrate the best in class features, functionality and low power operation of the AT21CS01 and AT21CS11. The kit was developed for engineers, developers, and decision makers to allow fast system prototyping using the Single-Wire interface for the AT21CS01 and AT21CS11 Single-Wire 1-Kbit Serial EEPROM devices.

The AT21CSMK100 Single-Wire Evaluation Kit includes an AVR base board (ATMembase) with a USB interface that allows users to quickly learn and experiment on their PCs. The kit also includes a personality board that interfaces with the base module via a 10-pin header. The Single-Wire Graphical User Interface (UI) includes a configuration environment that allows the user to configure, demonstrate, and personalize a Single-Wire Serial EEPROM memory device. The Single-Wire driver was developed using Atmel Studio Framework (ASF).



**Complete Support for the AT21CSMK100 Evaluation Kit is available at:**  
[www.atmel.com/products/memories/serial/single-wire.aspx?tab=tools](http://www.atmel.com/products/memories/serial/single-wire.aspx?tab=tools)

## Icon Key Identifiers

	<b>TIP</b>	Useful Tips and Techniques
	<b>INFO</b>	Delivers Contextual Information About a Specific Topic
	<b>IMPORTANT</b>	Note Related to a Specific Graphical UI Feature or Function
	<b>TO DO</b>	Objectives to be Completed
	<b>EXECUTE</b>	Action to be Executed
	<b>RESULT</b>	The Expected Result of an Assignment Step
	<b>CAUTION</b>	Procedure Which Can Result in Inconsistent Evaluation Kit Behavior
	<b>WARNING</b>	Procedure With Potential Equipment Damage
	<b>DANGER</b>	Procedure With Imminent Equipment Destruction

## Features

---

- Supports Atmel AT21CS01, SOT23 Package
  - Device is self-powered via 1.7V to 3.6V pull-up voltage on the SI/O line
- Supports Atmel AT21CS11, SOT23 Package
  - Device is self-powered via 2.7V to 4.5V pull-up voltage on the SI/O line
- AT24CS01 I<sup>2</sup>C 1Kbit Serial EEPROM with Unique Factory Programmed 128-bit Serial Number located on the Daughter Board
- Atmel AT90USB1287 AVR, 64 pad QFN device
  - 128K Bytes of in-system programmable Flash Memory
  - 4K Bytes EEPROM
  - 8K Bytes Internal SRAM
  - JTAG Interface
  - Supports FLIP Firmware Update
- Serial Interfaces
  - USB (Full and Low Speeds)
  - I<sup>2</sup>C
  - Single-Wire
- Voltage Level Shifters
- Power LED
- Three User Defined LEDs
- RESET button
- HWB button
  - Forces the Atmel AVR into Device Firmware Update (DFU) mode at reset
  - General purpose input switch
- 16MHz System Clock
- Main Board Power, 3.3V or 5V
- Variable socket V<sub>PUP</sub> voltage
- 16Bit ADC

# Table of Contents

<b>Introduction</b>	<b>1</b>
<b>Icon Key Identifiers</b>	<b>2</b>
<b>Features</b>	<b>3</b>
<b>Table of Contents</b>	<b>4</b>
<b>1 Installing the Graphical UI Software</b>	<b>6</b>
<b>2 AT21CSMK100 Evaluation Kit Setup</b>	<b>6</b>
<b>3 SEEPROM Graphical UI</b>	<b>8</b>
3.1 MAIN TITLE BAR	8
3.2 QUERY DEVICE	8
3.3 SYSTEM STATUS	8
3.3.1 Kit Revision	9
3.3.2 Firmware Revision	9
3.3.3 Personality Board Temp	9
3.3.4 Device In Socket	9
3.3.5 Personality Board Type	9
3.3.6 Personality Board Serial #	9
3.4 DEVICE CONDITIONS	9
3.4.1 Supply Voltage Slider	9
3.4.2 Frequency Slider (kbps)	10
3.4.3 Energy Consumed Gauge Meter	10
3.5 DEVICE STATUS	10
3.5.1 Serial Number	10
3.5.2 Slave Address	10
3.5.3 MFG ID Register	10
3.5.4 Security Register User Space	10
3.5.5 Zone Lock State	10
3.6 SET DEVICE PROTECTION	11
3.6.1 Zone Locked / Unlocked	11
3.6.2 Security Register Locked/Unlocked	11
3.7 DEVICE SPECIFICATION	11
3.8 Transaction Log	12
3.8.1 CLEAR LOG	12
3.8.2 EXPORT LOG	12
3.8.3 Legend	13
3.9 EEPROM ARRAY	13
3.10 ARRAY ACTIONS	14
3.10.1 HEX	14
3.10.2 ASCII	14
3.10.3 Load	14
3.10.4 Save	15
3.10.5 Program	15
3.10.6 Refresh	16
3.11 Security Register	16

3.12 ARRAY BUTTONS .....	16
3.12.1 Read .....	16
3.12.2 Write .....	17
3.12.3 Go To Address.....	17
3.12.4 Other Actions .....	17
3.12.5 Support.....	17
<b>4 Supported Device.....</b>	<b>18</b>
<b>5 Atmel SEEPROM Application Controller (ATMembase) .....</b>	<b>18</b>
5.1 In-System Programming .....	18
5.1.2 Programming with USB Bootloader: DFU (Device Firmware Upgrade) .....	19
5.1.3 Program debugging with the Atmel JTAGICE III.....	19
<b>6 Evaluation Kit Schematics .....</b>	<b>20</b>
6.1 Daughter Board Schematic .....	20
6.2 AT90USB1287 Schematic.....	20
<b>7 Troubleshooting Guide.....</b>	<b>21</b>
<b>Revision History .....</b>	<b>23</b>
<b>EVALUATION KIT IMPORTANT NOTICE AND DISCLAIMER .....</b>	<b>24</b>

# 1 Installing the Graphical UI Software

The following steps are needed to successfully install the Graphical UI Software:

1. Go to web address seen below to download the Atmel USB Driver:  
<http://www.atmel.com/System/BaseForm.aspx?target=tcm:26-66206>
2. Sign in using myAtmel Account or enter information as guest
3. Open the downloaded setup file and install driver by following the onscreen instructions:  
**driver-atmel-bundle-7.0.888.exe**
4. Follow the onscreen instructions to successfully install the Atmel USB Driver
5. Go to the web address seen below and download the latest Single-Wire Serial EEPROM Firmware:  
<http://www.atmel.com/tools/AT21CSMK100.aspx?tab=overview>
6. Open Setup File and install program by following the onscreen instructions:  
**Atmel-SEEPROM-Single-Wire-Firmware\_1.4.9.exe**



## CAUTION

The Graphical UI Software is not supported by Windows XP and Windows Vista operating systems. It is recommended that the software be installed on a Windows 7 operating system.

# 2 AT21CSMK100 Evaluation Kit Setup

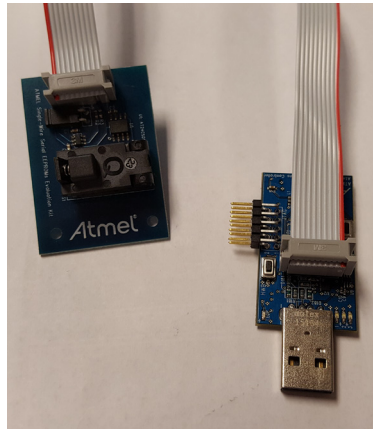

Figure 2. Using Supplied Ribbon Cable

The ATMicrobase and Daughter Board can be connected with or without the supplied ribbon cable. Figure 2 shows using the ribbon cable and Figure 3 shows without using the ribbon cable.

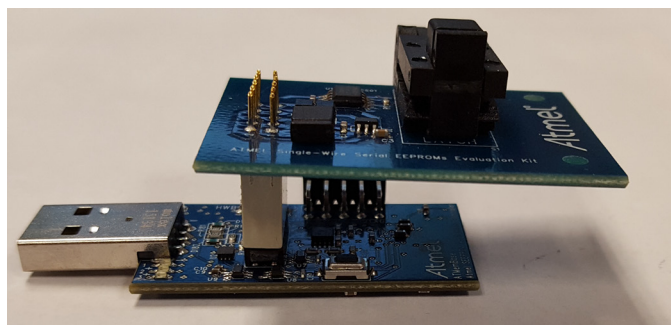
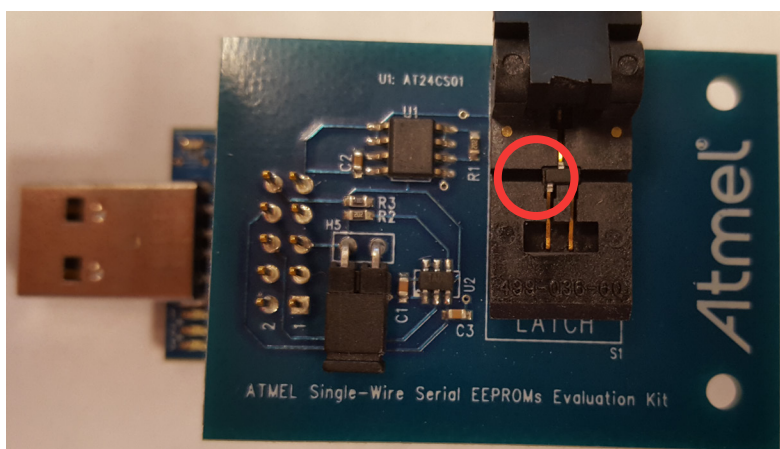

Figure 3. Direct Connection between ATMicrobase and Daughter Board

Once the ATMembase and Daughter Board are connected, the user must then install a device to be used as the Device Under Test (DUT) for the Evaluation Kit. Please refer to [Table 4-1](#) for supported devices for the Evaluation kit.

**i** INFO

When the AT21CSMK100 Evaluation Kit is shipped, there is a DUT already installed in the Daughter Board socket and the latest version of the ATMembase firmware programmed.



**Figure 4. AT21CS01 in SOT23 Socket**

**Figure 4** illustrates an AT21CS01 DUT in the Daughter Board 3 lead SOT-23 socket. Note that the latch is not closed in order to illustrate the DUT and the latch should be closed for proper DUT installation.



**TIP**

**Due to the small size of the 3 lead SOT-23 package, it is recommended to use tweezers in order to properly install a DUT in the Daughter Board socket.**

The firmware of the Graphical UI utilizes the AT21CS Series Reset and Discovery Response in order to determine whether the DUT is installed correctly in the Daughter Board socket. If the Discovery Response is not seen by the master (ATMembase), an error message is displayed in the Graphical UI stating that the DUT is not installed properly. For more information related to DUT Discovery Response, please refer to the [AT21CS Series Reset and Discovery Application Note](#).

Single-Wire Protocol devices only need two pins in order to communicate (SI/O and GND). These signals can be seen in [Figure 5](#). Pin 5 of the H1 header is the SI/O pin and Pin 9 of the H1 header is GND. Header H1 can be seen in greater detail in the [AT21CS01 Single-Wire Daughter Board Schematic](#). These pins can be used to capture Single-Wire protocol using an oscilloscope or any other tool designed to capture waveforms.

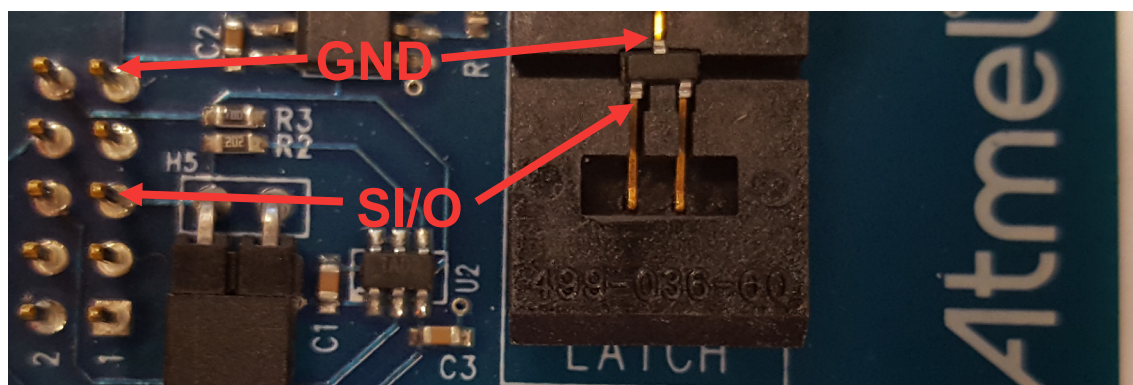

**Figure 5. DUT Signals**

Once a DUT is installed in the Daughter Board socket, the user can then plug in the ATMembase into one of their computers USB ports.

**CAUTION** The use of external USB hubs can induce inconsistent ATMembase behavior. Therefore, it is recommended to connect the ATMembase to a USB port that is directly connected to the user's computer when using the AT21CSMK100 Evaluation Kit.

## 3 SEEPROM Graphical UI

### 3.1 MAIN TITLE BAR

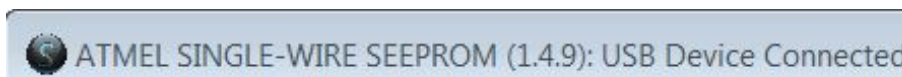

Figure 6. Main Title Bar

The main title bar displays the UI revision number and the USB connection status.

### 3.2 QUERY DEVICE



Figure 7. Query Device Button

The Graphical UI will perform an auto query when the kit is initially plugged in. Afterwards, the user can initiate a device query at any time with the Query Device button. Querying the device will populate the SYSTEM STATUS section, DEVICE STATUS section, and the Graphical UI Serial EEPROM array with the content of the connect memory device.

**CAUTION** If a new DUT is installed with the Graphical UI running and the ATMembase plugged into a USB port, the user must close the application, disconnect the ATMembase, and restart the application.

### 3.3 SYSTEM STATUS

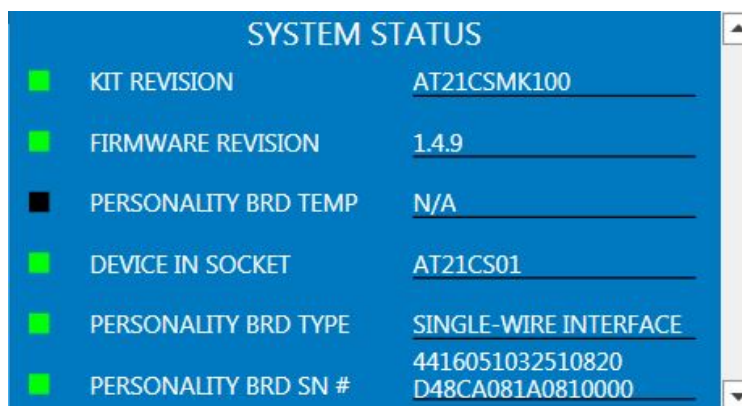

Figure 8. System Status Pane

The System Status pane illustrates various kit features including Firmware Revision and Daughter Board Serial Number.



### 3.3.1 Kit Revision

The Kit Revision displays the kit part number

### 3.3.2 Firmware Revision

This is the version of the firmware programmed in the ATMembase.

### 3.3.3 Personality Board Temp

N/A

### 3.3.4 Device In Socket

Identifies the product family of the DUT in the Daughter Board socket.

### 3.3.5 Personality Board Type

Identifies the communication protocol of the DUT. In this case, the Daughter Board is for Single-Wire protocol.

### 3.3.6 Personality Board Serial #

The Serial Number retrieved from the unique factory programmed Serial EEPROM, AT24CS01, located on the Daughter Board.

## 3.4 DEVICE CONDITIONS

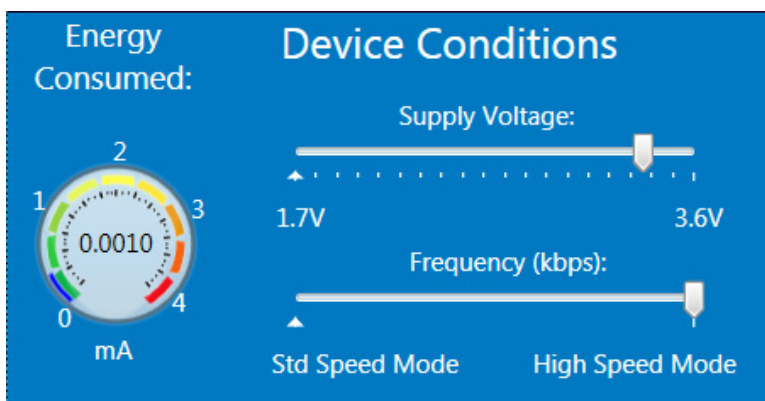

Figure 9. Device Conditions Pane

### 3.4.1 Supply Voltage Slider

The Voltage Slider provides the ability to change the DUT  $V_{PUP}$  voltage according to the DUT specification. On startup, the DUT  $V_{PUP}$  voltage defaults to 3.3V.



#### TIP

Due to the Pull-Up Resistor ( $R_{PUP}$ ) that is used on the Daughter Board, the Supply Voltage is limited to 1.8V for write or program operations. If the user decides to write/program at 1.7V, an error message is displayed inhibiting the write/program operation. See Figure 10 for the error message.

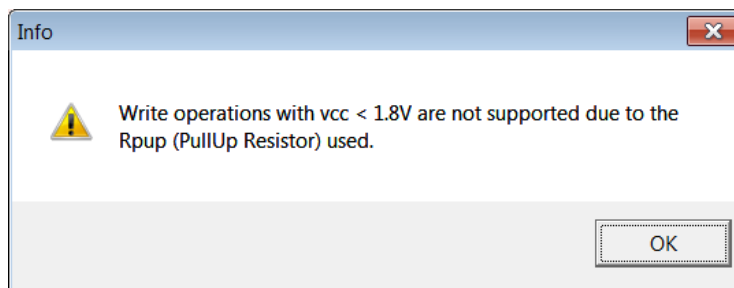

Figure 10. Voltage Slider Write/Program Message

### 3.4.2 Frequency Slider (kbps)

The Frequency Slider provides the ability to change the I/O speed between the microcontroller and the DUT. The AT21CS01 and AT21CS11 power-on default frequency setting is High Speed Mode.

### 3.4.3 Energy Consumed Gauge Meter

Displays DUT current consumption. The Energy Meter is updated when a write or read of the DUT is performed. After the read or write is completed, the standby current is measured and the Energy Meter is updated accordingly.

## 3.5 DEVICE STATUS

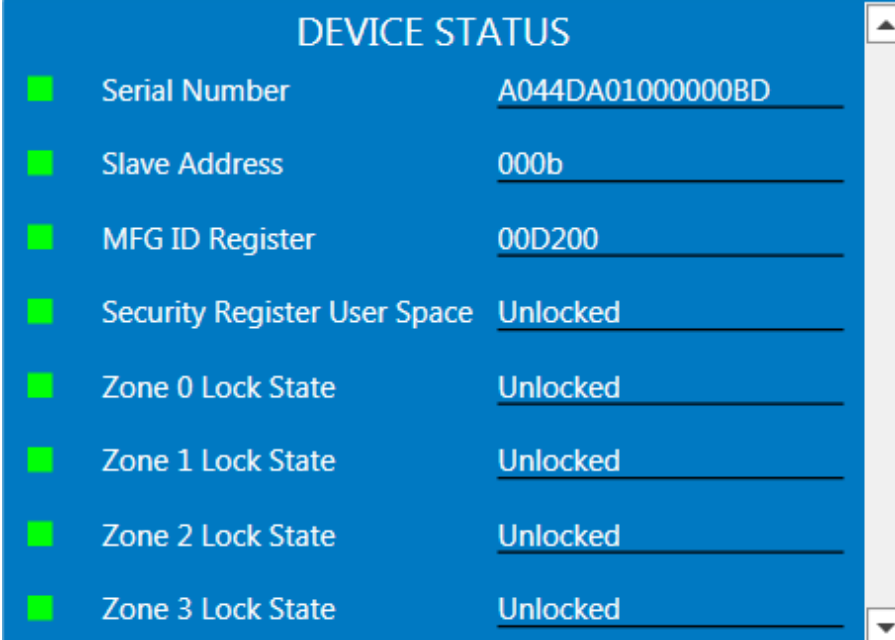

DEVICE STATUS	
Serial Number	A044DA01000000BD
Slave Address	000b
MFG ID Register	00D200
Security Register User Space	Unlocked
Zone 0 Lock State	Unlocked
Zone 1 Lock State	Unlocked
Zone 2 Lock State	Unlocked
Zone 3 Lock State	Unlocked

Figure 11. Device Status Pane

The Device status shows various device features including, Serial Number, the DUT Slave Address, the Manufacturer ID Register, and the Lock State for the various memory Zones (Zone 0 – Zone 3).

#### 3.5.1 Serial Number

Displays the Serial Number read from the DUT

#### 3.5.2 Slave Address

Preprogrammed device Slave Address of the DUT

#### 3.5.3 MFG ID Register

Reports the content of the DUT Manufacturer ID Register

#### 3.5.4 Security Register User Space

Reports the Lock State of the User Space of the Security Register

#### 3.5.5 Zone Lock State

Reports the Lock State for the respective memory Zones (Zone 0 – Zone 3)

## 3.6 SET DEVICE PROTECTION

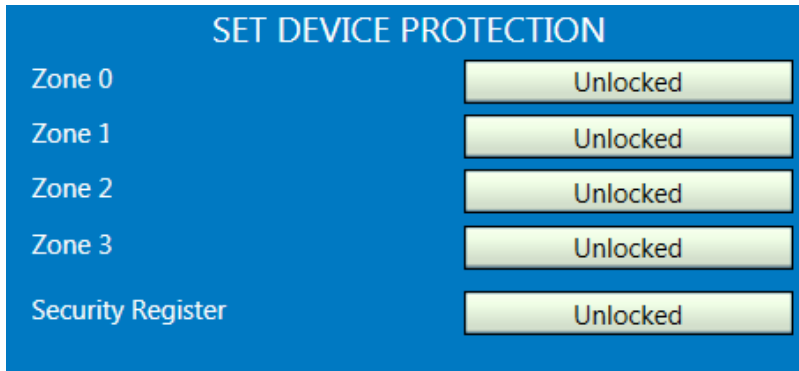

Figure 12. Set Device Protection Pane

The Set Device Protection shows the lock status of the four memory zones and the lock status the Security Register. This feature allows the user to independently lock the four memory zones and the Security Register based on the user application.

### 3.6.1 Zone Locked / Unlocked

These buttons are used to lock the respective memory locations.



**IMPORTANT**

Once locked, it is irreversible.

### 3.6.2 Security Register Locked/Unlocked

This button locks the user space of the Security Register.



**IMPORTANT**

Once locked, it is irreversible.

## 3.7 DEVICE SPECIFICATION

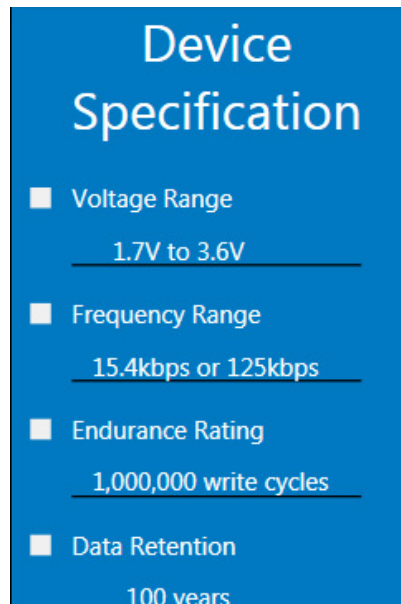

Figure 13. Device Specification Pane

The Device Specification pane displays key device parameters, which can be found in the DUTs datasheet. These parameters include the Voltage Range, Frequency Range, Endurance Rating, and Data Retention.

## 3.8 Transaction Log

Start	Data	Stop
11:03:22.33	<b>Read Mfg ID,</b> Start <b>C0</b> Restart by Mstr (Stop/Start) <b>C1</b> Response: <u>00D200</u> Stop	11:03:22.33
11:03:22.41	<b>Read Serial Number,</b> Start <b>B0 0x00</b> Restart by Mstr (Stop/Start) <b>B1</b> Response: <u>A044DA01000000BD</u> Stop	11:03:22.42
	<b>Check Lock Command,</b> Start <b>20 60</b>	

### Legend

- Device Address
- Word Address
- Data Input
- Data Output

Figure 14. Transaction log Pane

The Transaction Log records the all communication with the device as well as highlights the communication protocol according to the legend. The Transaction Log can be exported as an .html file if additional support is needed.

### 3.8.1 CLEAR LOG

The Clear Log Button clears the Transaction Log. The Clear Log function is helpful when the user is wanting to look at a specific type or group of Single-Wire protocol transaction(s).

### 3.8.2 EXPORT LOG

Start Time	Data	Stop Time
12:55:51.97	<b>Read Mfg ID,</b> Start <b>C1</b> Response: <u>00D200</u> Stop	12:55:51.98
12:55:52.03	<b>Read Serial Number,</b> Start <b>B0 0x00</b> Restart by Mstr (Stop/Start) <b>B1</b> Response: <u>A034B5010000005B1520</u> Stop	12:55:52.04

Figure 15. Export Log

The Export Log Button exports the Transaction Log in HTML format. The Export Log is automatically initiated if the Support button is pressed. For more information see [Section 3.12.5 Support](#).

### 3.8.3 Legend

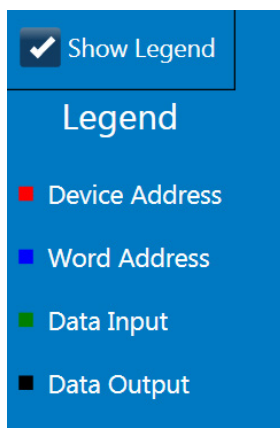

Figure 16. Legend

The Legend highlights the different fields of bytes in the Single-Wire protocol that is being sent/received from the DUT. The Show Legend function can either show or hide the Transaction Log Legend.

### 3.9 EEPROM ARRAY

FF	FF	FF	FF	FF	FF	FF	FF
FF	FF	FF	FF	FF	FF	FF	FF
FF	FF	FF	FF	FF	FF	FF	FF
FF	FF	FF	FF	FF	FF	FF	FF
FF	FF	FF	FF	FF	FF	FF	FF
FF	FF	FF	FF	FF	FF	FF	FF
FF	FF	FF	FF	FF	FF	FF	FF
FF	FF	FF	FF	FF	FF	FF	FF
FF	FF	FF	FF	FF	FF	FF	FF
FF	FF	FF	FF	FF	FF	FF	FF

Figure 17. Graphical UI EEPROM Array

Array shading is based on Zone Lock state. Green indicates zone has not been locked and user can write to that Word Address or range of Word Addresses. Pink indicates the region has been locked and now functions as Read Only Memory (ROM). Yellow indicates that the cell has been changed in the buffer and is not programmed to DUT memory (See [Section 3.10.5 Program](#) for additional information).

FF	FF	FF
FF	FF	FF
FF	FF	FF
FF	FF	FF
FF	FF	FF
FF	FF	FF

Hex: FF  
 ASCII: ÿ  
 Address: 1A  
 Zone: 0  
 Is locked: False

Figure 18. Cell Hovering

When hovering over cells, a pop up appears to show Data in HEX and ASCII, Address, Zone #, and Zone Protection State. This is illustrated in [Figure 18](#).

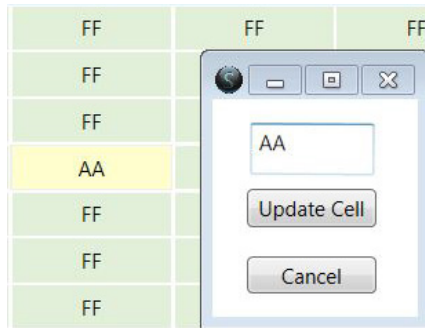

**Figure 19. Update Cell**

The user can change the content of a cell by double-clicking a Word Address of the EEPROM array (see [Figure 19](#)). In order to change the content of a cell, the user should update the value, followed by pressing the Update Cell button. Once the cell is updated, the cell shading will be yellow. The user must then program the device using the Program Feature after Update Cell is pressed (See [Section 3.10.5 Program](#) for additional information).

## 3.10 ARRAY ACTIONS

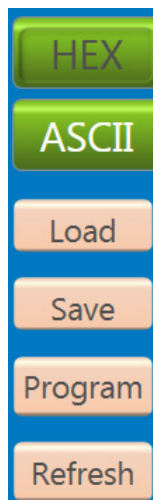

**Figure 20. Array Actions**

### 3.10.1 HEX

The HEX Button displays the Graphical UI Serial EEPROM memory array in HEX format

### 3.10.2 ASCII

The ASCII Button displays the Graphical UI Serial EEPROM memory array in ASCII format

### 3.10.3 Load

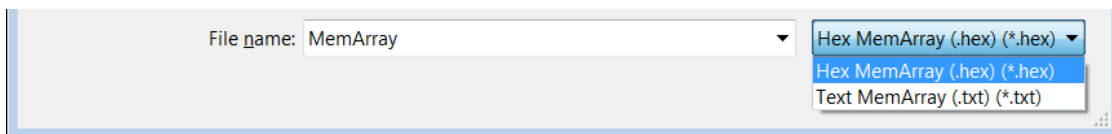

**Figure 21. Load Function**

The Load feature gives the user the option to load a previous saved HEX (.hex) or TEXT (.txt) file to populate the memory array. In Order to write to the Serial EEPROM memory array using the Load feature, the user must program the device using the Program Feature (See [Section 3.10.5 Program](#) for additional information).

### 3.10.4 Save

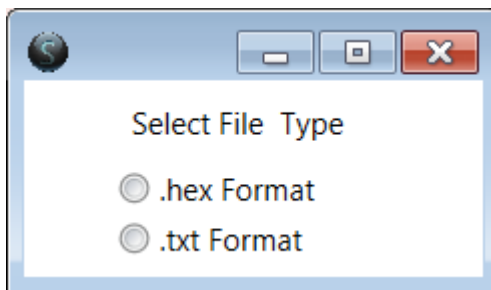

Figure 22. Save Function

The Save feature gives the user the ability to save the Serial EEPROM memory array. The memory array can be saved as either a HEX (.hex) file or TEXT (.txt) file based on the user preference. Once a file type is selected, a file explorer will pop up and save the file.

### 3.10.5 Program

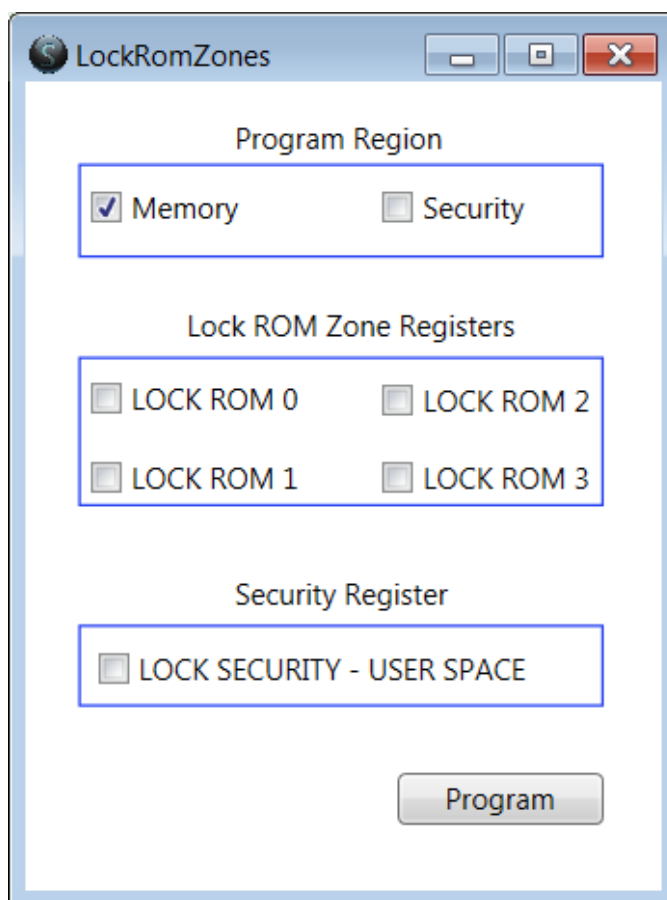

Figure 23. Program Function

The Program function can be used to write to the Serial EEPROM memory, the Security Register, Lock Zone 0 to Zone 3, and even lock the User Space of the Security Register.

When the Program button is pressed, the Graphical UI buffer is written to the Serial EEPROM memory. The Program button must be pressed when a cell is updated, or when a file (.hex or .txt) is loaded. If the program button is not pressed, and the Graphical UI is stopped, the data in the buffer will not be written to the Serial EEPROM memory.

The Program button can also be used to lock the four memory zones and the Security Register. Please refer to [Section 3.6 Set Device Protection](#) for additional information related to locking a Zone(s).

### 3.10.6 Refresh

The Refresh operation reads the entire memory array of the device and then updates the Graphical UI EEPROM array. This operation also updates the Graphical UI Security Register.

## 3.11 Security Register

Security Register							
A0	44	DA	01	00	00	00	BD
RFU	RFU	RFU	RFU	RFU	RFU	RFU	RFU
FF	FF	FF	FF	FF	FF	FF	FF
FF	FF	FF	FF	FF	FF	FF	FF

Figure 24. Security Register

Only the User Space (green cells) can be modified by user. The pink colored cells indicate they are locked and cannot be modified by user. Figure 24 illustrates the Device Default Condition of the Security Register.



#### IMPORTANT

Once locked, it is irreversible.

## 3.12 ARRAY BUTTONS



Figure 25. Array Buttons

### 3.12.1 Read

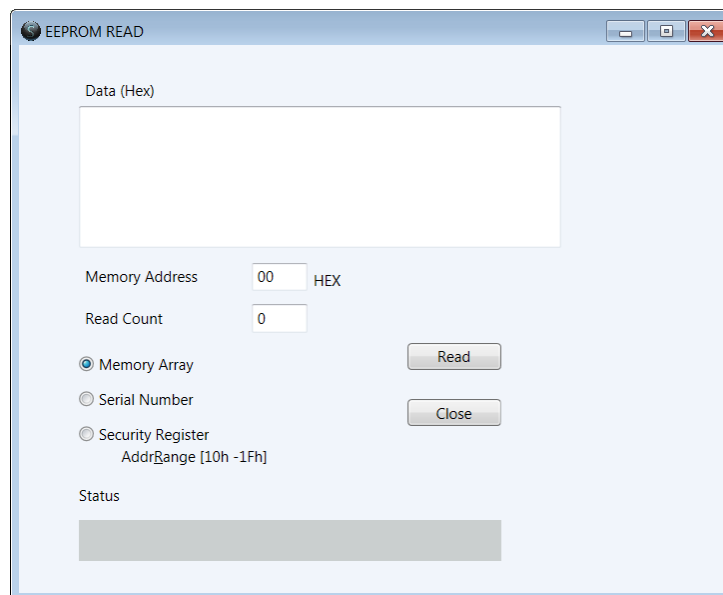

Figure 26. Read Button Window

The Read feature allows user to read the entire memory array of the device, a specific Word Address or a range of Word Addresses, the Serial Number of the DUT, or the Security Register.



#### INFO

If the user reads the Security Register or the Serial Number, the Graphical UI automatically populates the Memory Address for the user starting at the first byte of the first page of either the User Space of the Security Register or the Serial Number.



### 3.12.2 Write

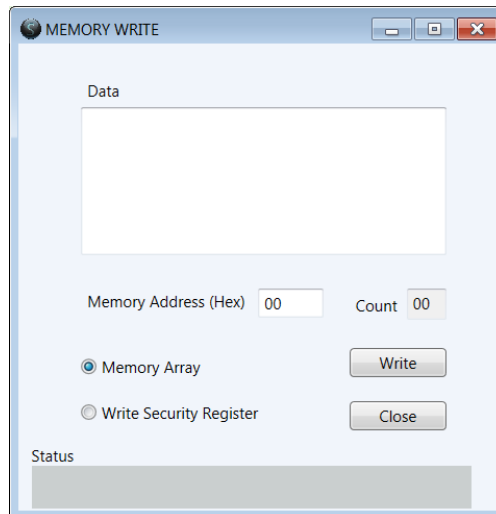

Figure 27. Write Button Window

The Write feature allows user to write the entire memory array of the device, a specific Word Address (Byte Write) or a range of Word Addresses. The user can also write to the 16 bytes of User Space in the Security Register.



#### INFO

**If the user writes to the Security Register, the Graphical UI automatically populates the Memory Address for the user starting at the first byte of the first page of the User Space of the Security Register.**

### 3.12.3 Go To Address

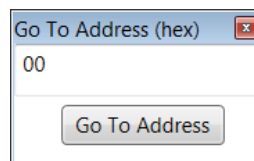

Figure 28. Go To Address

The Go To Address feature allows user to jump to a specific known Hex address in the Graphical UI EEPROM array to read, write, or view that Word Address location. Once the Go To Address button is pressed, the Memory Address will be highlighted in a black box.

### 3.12.4 Other Actions

This button is reserved for future use (RFU) for when the future enhancements will be made.

### 3.12.5 Support

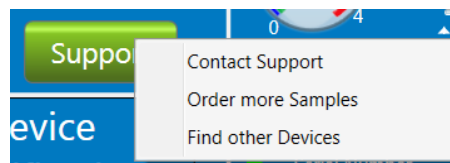

Figure 29. Support

The support button provides hyperlinks to:

- Contact Support
  - An automatic email will be generated addressed to the Atmel support team with a copy of the transaction log attached to the email.
- Order more samples
- Find other devices

## 4 Supported Device

Table 4-1. Personality Board Supported Devices

Personality Board Part Number	Device	Communication Interface	Socket Type
AT21CSMK100	AT21CS01-STUM##-T*	Single-Wire, I/O Powered	SOT23
AT21CSMK100	AT21CS11-STUM##-T*	Single-Wire, I/O Powered	SOT23



### INFO

\* Indicates the desired one of eight Slave Address choices. Please see the corresponding device datasheet for more information

## 5 Atmel SEEPROM Application Controller (ATMembase)

Table 5-1. ATMembase I/O Interface

Pin Number	Name	Description	Comments
PE2	HWB	Hardware Button	General Purpose
PD6	LED1	User LED	Red
PD5	LED2	User LED	Red
PD4	LED3	User LED	Red

Table 5-2. ATMembase 10-Pin Expansion Header

J1 Header	Name of J1	AVR Pin	Comments
1	SCLK	PB1	
2	MOSI	PB2	
3	MISO	PB3	
4	/SS	PB0	
5	SDA	PD1	Single-Wire Communication GPIO
6	GPIO0	PD2	Input from TS1101 Sign signal
7	SCL	PD0	
8	GPIO1	PF1	Input from TS1101 Out signal
9	GND		
10	VCC		

### 5.1 In-System Programming

The ATMembase can be programmed and debugged by connecting an external programming/debugging tool to the “JTAG & PDI” header pinout shown in [Table 5-3](#). The header has a standard pin-out and therefore tools like the Atmel JTAGICEIII or Atmel AVR ONE can be connected to the header.

**Table 5-3. ATMembase Programming and debugging interface – JTAG and PDI**

Pin on Programming Header	JTAG	PDI
1	TCK	-
2	GND	GND
3	TDO	DATA
4	VCC	VCC
5	TMS	-
6	nSRST	CLK
7	NC	-
8	NC	-
9	TDI	-
10	GND	GND

### 5.1.2 Programming with USB Bootloader: Device Firmware Upgrade (DFU)

The Atmel AT90USB1287 AVR comes with a default factory pre-programmed USB bootloader located in the on-chip boot section of the AT90USB1287. This is the easiest and fastest way to reprogram the device directly over the USB interface. The FLIP PC Application, available for free on the Atmel website, offers a flexible and user friendly interface for reprogramming the application over the USB bus. FLIP can be found at the following hyperlink:

<http://www.atmel.com/tools/flip.aspx>

The “HWB” push button is used to place the AVR into DFU mode after reset. Refer to the Atmel [AT90USB1287 Datasheet](#) for further information.

The following steps enable the ATMembase DFU mode:

1. Press and hold “HWB” button
2. Press the “RESET” button
3. Release the “RESET” button
4. Release the “HWB” button



**IMPORTANT** HWBE fuse must be enabled to support DFU



**CAUTION** The use of external USB hubs can induce inconsistent programming behavior of the ATMembase. Therefore, it is recommended to connect the ATMembase to a USB port that is directly connected to the user’s computer during Flip DFU programming.

For more information related to the USB bootloader and the use of FLIP software, please refer to Application Note found at the following hyperlink:

<http://www.atmel.com/images/Atmel-8991-SEEPROM-Upgrade-Kit-FW-Using-FLIP-ApplicationNote.pdf>

### 5.1.3 Program debugging with the Atmel JTAGICE III

The AT90USB1287 can be programmed using the specific JTAG link. This subsection will explain how to connect and use the Atmel AVR JTAG ICE.



**TIP** When the JTAGEN fuse is disabled, the four TAP pins are normal port pins, and the TAP controller is in reset. When the JTAGEN fuse is enabled, the input TAP signals are internally pulled high. This enables the JATG for boundary-scan and programming. The Atmel AT90USB1287 device is shipped with this fuse programmed

# 6 Evaluation Kit Schematics

## 6.1 Daughter Board Schematic

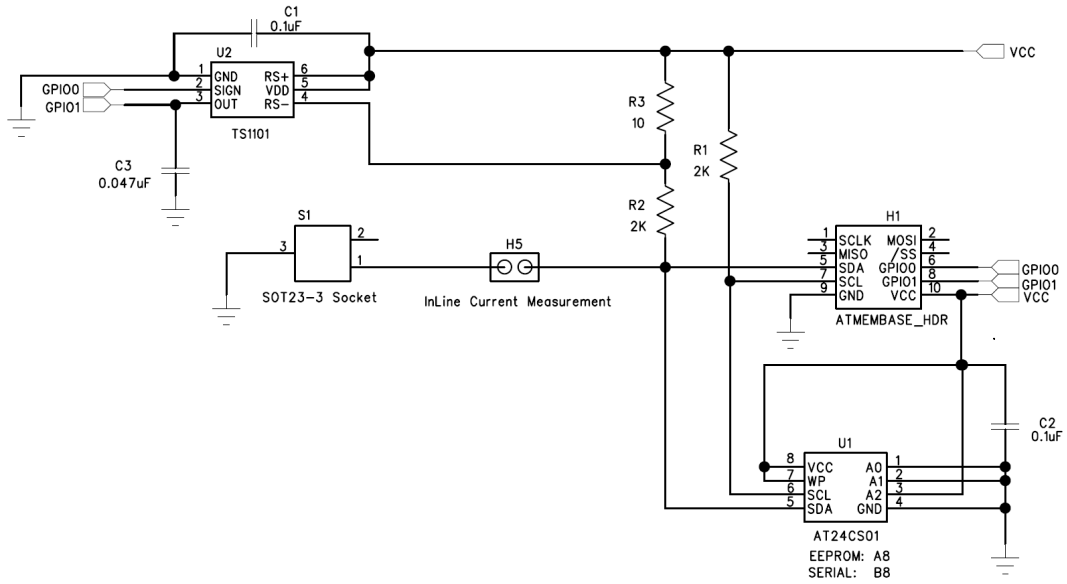

Figure 30. Daughter Board Schematic

## 6.2 AT90USB1287 Schematic

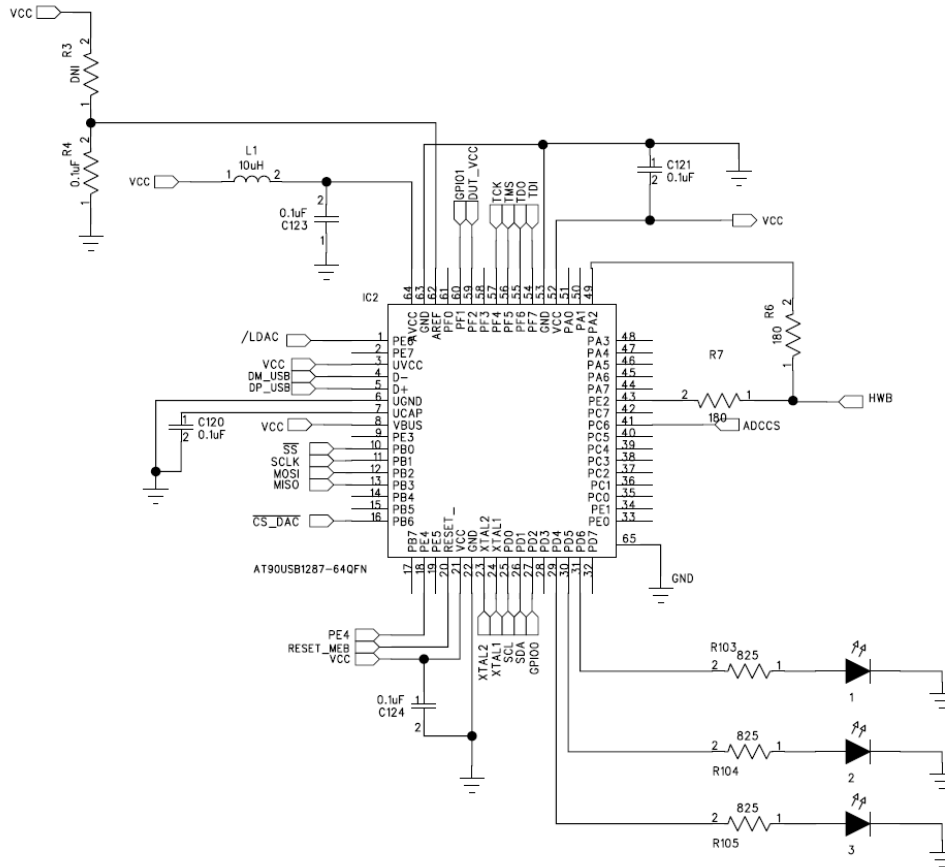
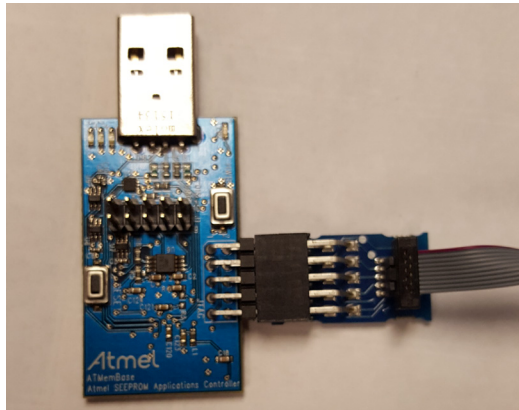

Figure 31. AT90USB1287 Schematic

## 7 Troubleshooting Guide

**Issue:** The ATMembase no longer has the USB Bootloader Installed

**Resolution:** In order to reprogram the USB bootloader, the user needs an Atmel JTAG ICEIII and the latest version of Atmel Studio installed. Plug in the JTAG ICEIII and power the ATMembase using another USB port. Plug the JTAG ICEIII cable into the JTAG header found on the ATMembase referring to [Figure 32](#) as needed.



**Figure 32. ATMembase and JTAG ICEIII Connector**

In Atmel Studio, navigate to Device Programming under Tools. Select the JTAG ICEIII as your tool and AT90USB1287 as your Device, click Apply. Navigate to Memories and browse for the bootloader under Flash (128Kb). Navigate to:

C:\Program Files (x86)\Atmel\Atmel Seeeprom\2Wire\bootloader\

Select the at90usb128-bl-usb-1\_0\_1.hex file, and press the Program Button. Navigate to Fuses and set the fuses according to the Fuse Values seen in [Figure 33](#). Program the ATMembase.

Fuse Register	Value
EXTENDED	0xF4
HIGH	0x99
LOW	0xFF

**Figure 33. ATMembase Fuse Settings**

Once the Fuse Values are programmed, please close Device Programming and Exit Atmel Studio. Open FLIP and follow the instructions outlined in the Application Note found on Atmel.com at:

<http://www.atmel.com/Images/Atmel-8991-SEEPRM-Upgrade-Kit-FW-Using-FLIP-ApplicationNote.pdf>



### CAUTION

**The use of external USB hubs can induce inconsistent programming behavior of the ATMembase. Therefore, it is recommended to connect the ATMembase to a USB port that is directly connected to the user's computer during Flip DFU programming.**

**Issue:** ATMembase is not recognized by the computer

**Resolution:** The Atmel USB Driver is not installed or is not installed properly. Please visit <http://www.atmel.com/System/BaseForm.aspx?target=tcm:26-66206> to download the USB Driver

**Issue:** Graphical UI states the ATMembase needs a firmware update

**Resolution:** Please follow the steps outlined in the Application Note found on Atmel.com at: <http://www.atmel.com/Images/Atmel-8991-SEEPROM-Upgrade-Kit-FW-Using-FLIP-ApplicationNote.pdf>

**Issue:** Graphical UI States there is not DUT Installed

**Resolution:** Verify that the DUT is installed correctly, referring to [Figure 4](#). If the problem still exists, verify the H5 Shunt is installed properly. Refer to [AT21CS01 Single-Wire Daughter Board Schematic](#) to locate the H5 Shunt. H5 is also written on the Daughter Board silk screen.

**Issue:** FLIP Software Can't Program the ATMembase

**Resolution:** Please follow the steps outlined in the Application Note found on Atmel.com at: <http://www.atmel.com/Images/Atmel-8991-SEEPROM-Upgrade-Kit-FW-Using-FLIP-ApplicationNote.pdf>

If the issue still exists, verify that the USB Bootloader is installed correctly. Please follow the instructions outline in the [Troubleshooting Guide](#).

If the issue still exists, verify that you are not plugging the ATMembase into a USB hub. If this is the case, it is recommended to connect the ATMembase to a USB port that is directly powered by the computer and follow the programming instructions.

## Revision History

Doc No.	Date	Comments
8993B	07/13/2016	Change pictures to reflect latest version (1.4.9)
8993A	06/21/2016	Initial document release

# EVALUATION KIT IMPORTANT NOTICE AND DISCLAIMER

This evaluation board/kit is intended for user's internal development and evaluation purposes only. It is not a finished product and may not comply with technical or legal requirements that are applicable to finished products, including, without limitation, directives or regulations relating to electromagnetic compatibility, recycling (WEEE), FCC, CE or UL. Atmel is providing this evaluation board/kit "AS IS" without any warranties or indemnities. The user assumes all responsibility and liability for handling and use of the evaluation board/kit including, without limitation, the responsibility to take any and all appropriate precautions with regard to electrostatic discharge and other technical issues. User indemnifies Atmel from any claim arising from user's handling or use of this evaluation board/kit. Except for the limited purpose of internal development and evaluation as specified above, no license, express or implied, by estoppel or otherwise, to any Atmel intellectual property right is granted hereunder. ATMEL SHALL NOT BE LIABLE FOR ANY INDIRECT, SPECIAL, INCIDENTAL, OR CONSEQUENTIAL DAMAGES RELATING TO USE OF THIS EVALUATION BOARD/KIT.

ATMEL CORPORATION  
1600 Technology Drive  
San Jose, CA 95110  
USA



Atmel® | Enabling Unlimited Possibilities®



Atmel Corporation | 1600 Technology Drive, San Jose, CA 95110 USA | T: (+1)(408) 441.0311 | F: (+1)(408) 436.4200 | [www.atmel.com](http://www.atmel.com)

© 2015 Atmel Corporation. / Rev.: Atmel-8993-SEEPROM-AT21CSMK100-UserGuide

Atmel®, Atmel logo and combinations thereof, Enabling Unlimited Possibilities®, and others are registered trademarks or trademarks of Atmel Corporation in U.S. and other countries. ARM®, ARM Connected® logo, and others are the registered trademarks or trademarks of ARM Ltd. Other terms and product names may be trademarks of others.

DISCLAIMER: The information in this document is provided in connection with Atmel products. No license, express or implied, by estoppel or otherwise, to any intellectual property right is granted by this document or in connection with the sale of Atmel products. EXCEPT AS SET FORTH IN THE ATMEL TERMS AND CONDITIONS OF SALES LOCATED ON THE ATMEL WEBSITE, ATMEL ASSUMES NO LIABILITY WHATSOEVER AND DISCLAIMS ANY EXPRESS, IMPLIED OR STATUTORY WARRANTY RELATING TO ITS PRODUCTS INCLUDING, BUT NOT LIMITED TO, THE IMPLIED WARRANTY OF MERCHANTABILITY, FITNESS FOR A PARTICULAR PURPOSE, OR NON-INFRINGEMENT. IN NO EVENT SHALL ATMEL BE LIABLE FOR ANY DIRECT, INDIRECT, CONSEQUENTIAL, PUNITIVE, SPECIAL OR INCIDENTAL DAMAGES (INCLUDING, WITHOUT LIMITATION, DAMAGES FOR LOSS AND PROFITS, BUSINESS INTERRUPTION, OR LOSS OF INFORMATION) ARISING OUT OF THE USE OR INABILITY TO USE THIS DOCUMENT, EVEN IF ATMEL HAS BEEN ADVISED OF THE POSSIBILITY OF SUCH DAMAGES. Atmel makes no representations or warranties with respect to the accuracy or completeness of the contents of this document and reserves the right to make changes to specifications and products descriptions at any time without notice. Atmel does not make any commitment to update the information contained herein. Unless specifically provided otherwise, Atmel products are not suitable for, and shall not be used in, automotive applications. Atmel products are not intended, authorized, or warranted for use as components in applications intended to support or sustain life.

SAFETY-CRITICAL, MILITARY, AND AUTOMOTIVE APPLICATIONS DISCLAIMER: Atmel products are not designed for and will not be used in connection with any applications where the failure of such products would reasonably be expected to result in significant personal injury or death ("Safety-Critical Applications") without an Atmel officer's specific written consent. Safety-Critical Applications include, without limitation, life support devices and systems, equipment or systems for the operation of nuclear facilities and weapons systems. Atmel products are not designed nor intended for use in military or aerospace applications or environments unless specifically designated by Atmel as military-grade. Atmel products are not designed nor intended for use in automotive applications unless specifically designated by Atmel as automotive-grade.