

THESE DRAWINGS ARE THE PROPERTY OF QUALTEK ELECTRONICS AND NOT TO BE REPRODUCED FOR OR COMMUNICATED TO A THIRD PARTY WITHOUT THE EXPRESS WRITTEN PERMISSION OF AN OFFICER OF QUALTEK ELECTRONICS.

REVISION			
REV.	DESCRIPTION	DATE	APPROVED

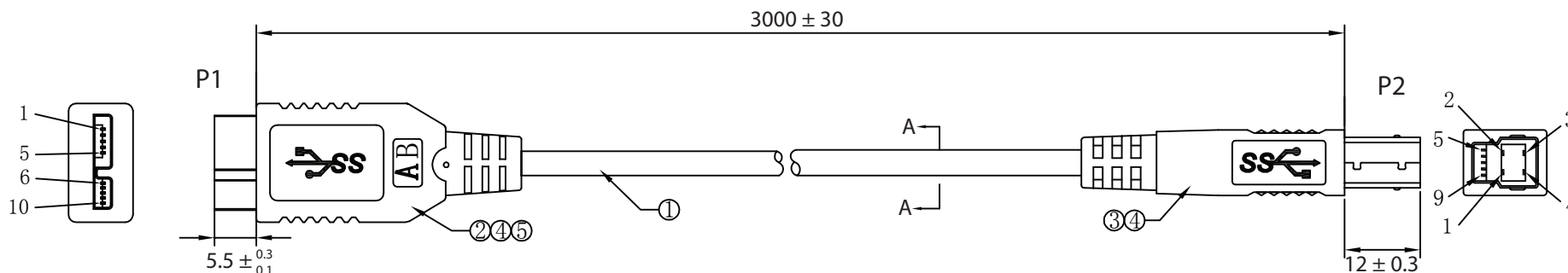

**WIRING:**

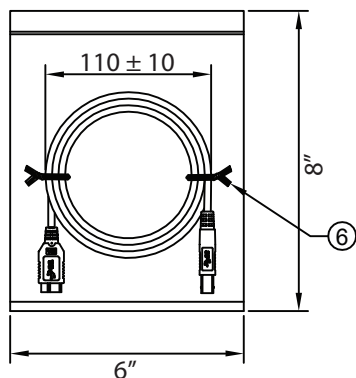

P1	COLOR	P2
1	RED	1
2	WHITE	2
3	GREEN	3
4	BLACK	4
5	BLUE	8
6	YELLOW	9
7	DRAIN WIRE	7
8	PURPLE	5
9	ORANGE	6
10	BRAID	SHIELD

**CONTROLLED**

No.	PARTS NAME	SPECIFICATION STANDARD	QTY	REMARKS
①	CABLE	UL 20276 O.D. 5.5mm COLOR: BLACK	1	
②	MICRO USB3.0 A B M 10PIN GOLD PLATED	15U" SHELL NICKEL PLATED INSULATOR BLACK	1	
③	USB3.0 B M 9PIN GOLD PLATED	30U" SHELL NICKEL PLATED INSULATOR BLUE	1	
④	PVC	45P PVC BLACK	18	g
⑤	PE	CLEAR PE	2	g
⑥	CABLE TIE	L=9cm COLOR: BLACK	2	

**NOTES:**

- CABLE: UL20276  
(1Px30AWG+D+AL+MY)x2C+1Px30AWG+2Cx24AWG+AL+B  
OUTER JACKET: BLACK, O.D.: 5.5mm
- CONNECTORS: MICRO USB 3.0 A MALE TO USB 3.0 B MALE
- HOOD: MOLDED TYPE, COLOR: BLACK
- PACKING: 1PC/POLYBAG
- RoHS COMPLIANT

Dim range (mm)	Tolerance +/- (mm)	Qualtek Electronics Corp. WCI DIVISION		
		Part Number: 3023033-03M		RoHS Compliant
0-1	0.15	Description: MICRO USB 3.0 A B/M - USB 3.0 B/M		
1-6	0.20	UNIT: mm		
6-18	0.30	UNIT: mm		
18-50	0.50	UNIT: mm		
50-120	0.70	Drawn / Date	Checked / Date	Approved / Date
120-250	0.90	R.Nuti 06-25-10	06-25-10	LY / 06-25-10
250-500	1.20			