

NPN General Purpose Transistor

BC848BW / BC848B

●Features

- 1) V_{CE0} minimum is 30V ($I_C=1\text{mA}$)
- 2) Complements the BC858B / BC858BW.

●External dimensions (Unit : mm)

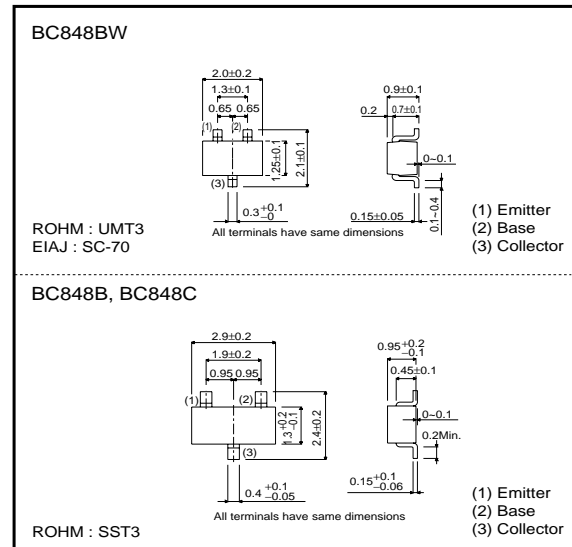

●Absolute maximum ratings ($T_a=25^\circ\text{C}$)

Parameter	Symbol	Limits	Unit	
Collector-base voltage	V_{CB0}	30	V	
Collector-emitter voltage	V_{CE0}	30	V	
Emitter-base voltage	V_{EB0}	5	V	
Collector current	I_C	0.1	A	
Collector power dissipation	BC848BW	P_C	0.2	W
			0.2	W
			0.35	W *
Junction temperature	T_j	150	$^\circ\text{C}$	
Storage temperature	T_{stg}	-65~+150	$^\circ\text{C}$	

* When mounted on a 7×5×0.6mm ceramic board.

●Electrical characteristics ($T_a=25^\circ\text{C}$)

Parameter	Symbol	Min.	Typ.	Max.	Unit	Conditions
Collector-base breakdown voltage	BV_{CB0}	30	—	—	V	$I_C=50\mu\text{A}$
Collector-emitter breakdown voltage	BV_{CE0}	30	—	—	V	$I_C=1\text{mA}$
Emitter-base breakdown voltage	BV_{EB0}	5	—	—	V	$I_E=50\mu\text{A}$
Collector cutoff current	I_{CBO}	—	—	100	nA	$V_{CB}=30\text{V}$
		—	—	5	μA	$V_{CB}=30\text{V}, T_a=150^\circ\text{C}$
Collector-emitter saturation voltage	$V_{CE(sat)}$	—	—	0.25	V	$I_C/I_B=10\text{mA}/0.5\text{mA}$
		—	—	0.6	V	$I_C/I_B=100\text{mA}/5\text{mA}$
Base-emitter saturation voltage	$V_{BE(on)}$	0.58	—	0.77	V	$V_{CE}/I_C=5\text{V}/10\text{mA}$
DC current transfer ratio	h_{FE}	200	—	450	—	$V_{CE}/I_C=5\text{V}/2\text{mA}$
Transition frequency	f_T	—	200	—	MHz	$V_{CE}=5\text{V}, I_E=-20\text{mA}, f=100\text{MHz}$
Collector output capacitance	C_{ob}	—	3	—	pF	$V_{CB}=10\text{V}, I_E=0, f=1\text{MHz}$
Collector output capacitance	C_{ib}	—	8	—	pF	$V_{EB}=0.5\text{V}, I_E=0, f=1\text{MHz}$

(SPEC-C22)

Transistors

●Packaging specifications

Part No.	BC848BW	BC848B
Packaging type	UMT3	SST3
Marking	G1K	G1K
Code	T106	T116
Basic ordering unit (pieces)	3000	3000

●Electrical characteristic curves

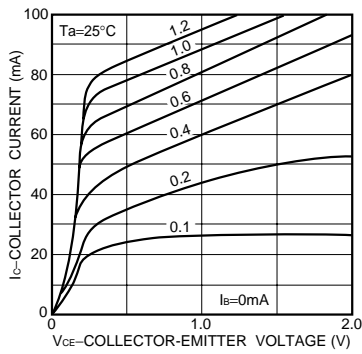

Fig.1 Grounded emitter output characteristics (I)

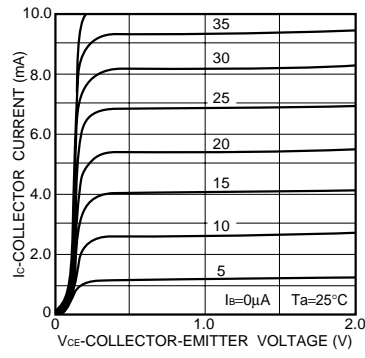

Fig.2 Grounded emitter output characteristics (II)

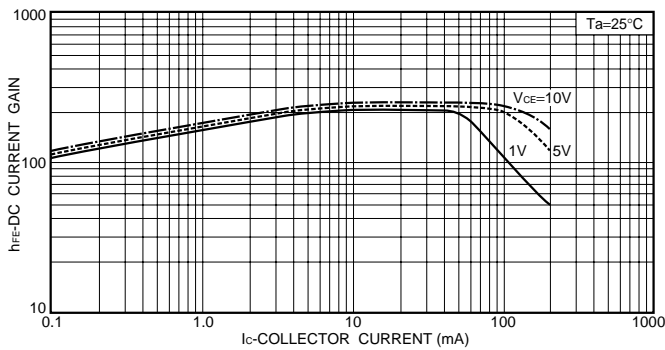

Fig.3 DC current gain vs. collector current (I)

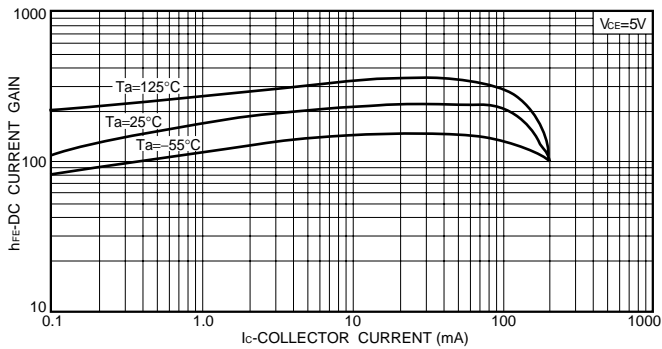

Fig.4 DC current gain vs. collector current (II)

Transistors

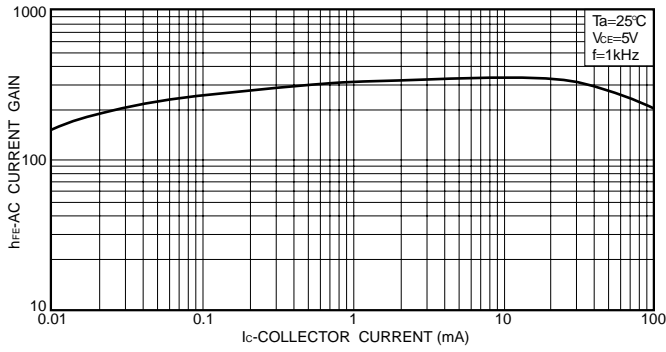

Fig.5 AC current gain vs. collector current

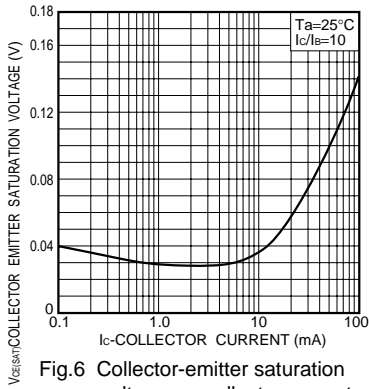

Fig.6 Collector-emitter saturation voltage vs. collector current

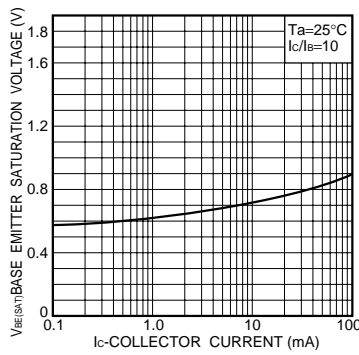

Fig.7 Base-emitter saturation voltage vs. collector current

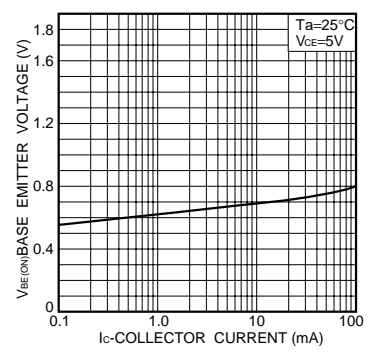

Fig.8 Grounded emitter propagation characteristics

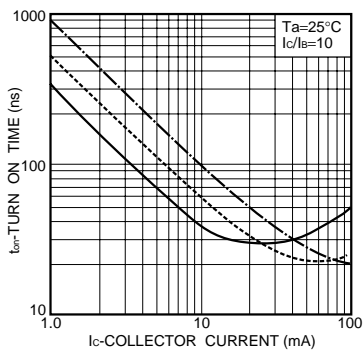

Fig.9 Turn-on time vs. collector current

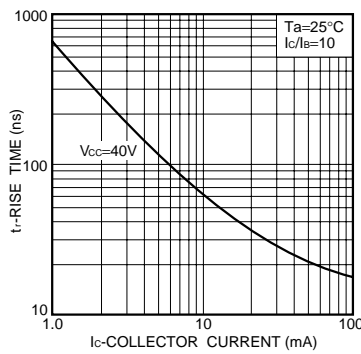

Fig.10 Rise time vs. collector current

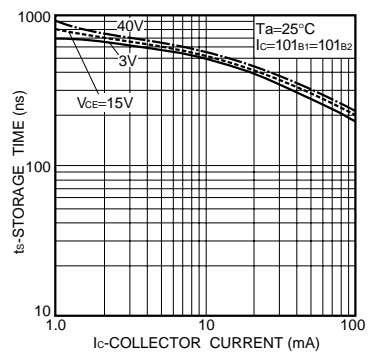

Fig.11 Storage time vs. collector current

Transistors

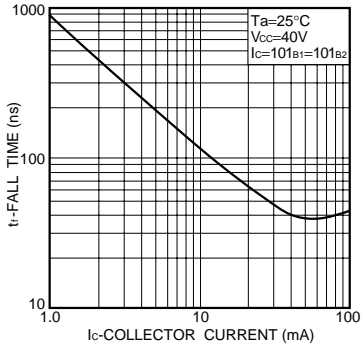

Fig.12 Fall time vs. collector current

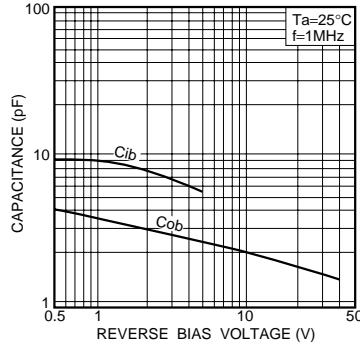

Fig.13 Input/output capacitance vs. voltage

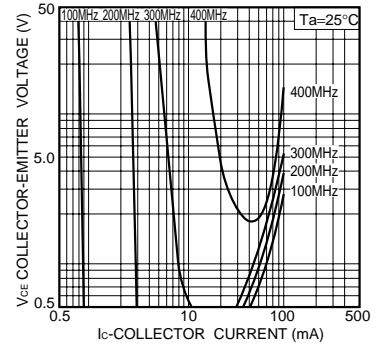

Fig.14 Gain bandwidth product

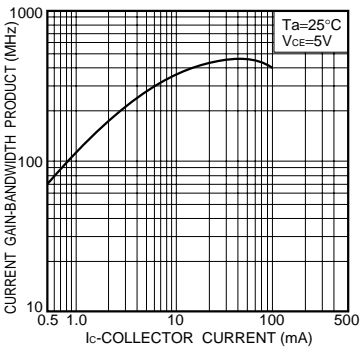

Fig.15 Gain bandwidth product vs. collector current

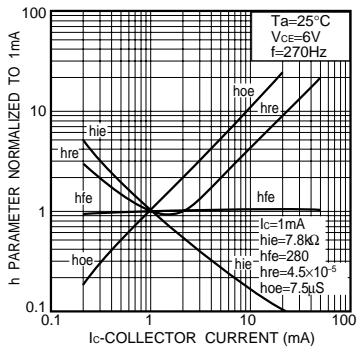

Fig.16 h parameter vs. collector current

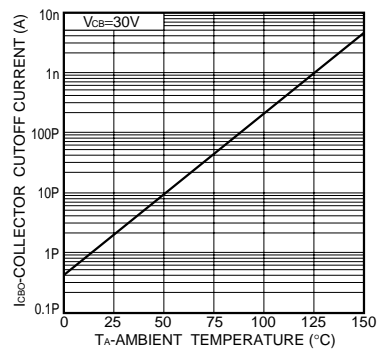

Fig.17 Collector cutoff current

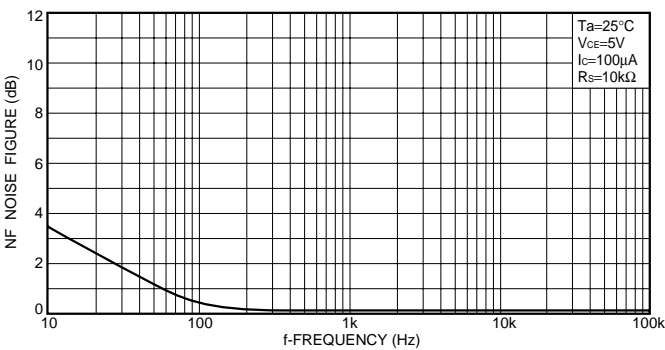

Fig.18 Noise vs. collector current

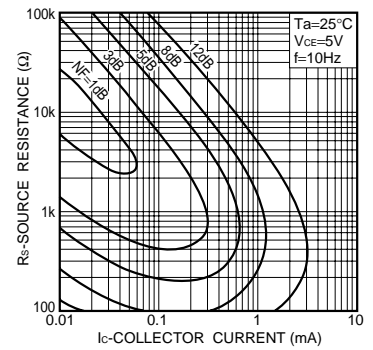

Fig.19 Noise characteristics (I)

Transistors

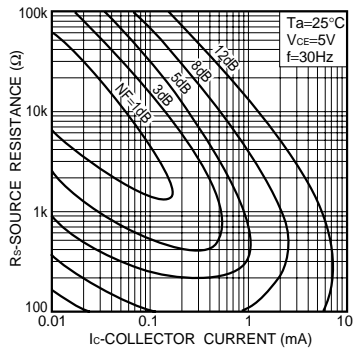

Fig.20 Noise characteristics (II)

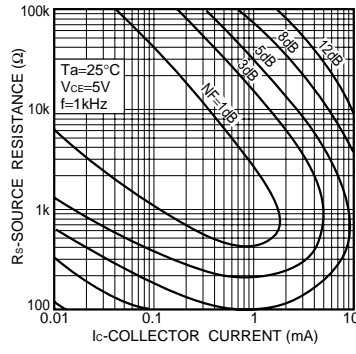

Fig.21 Noise characteristics (III)

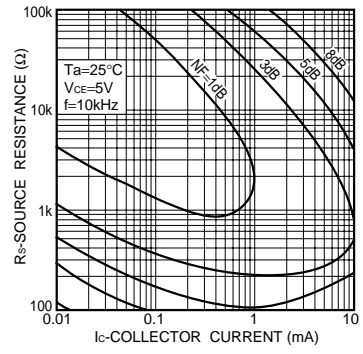

Fig.22 Noise characteristics (IV)

Notes

- No technical content pages of this document may be reproduced in any form or transmitted by any means without prior permission of ROHM CO.,LTD.
- The contents described herein are subject to change without notice. The specifications for the product described in this document are for reference only. Upon actual use, therefore, please request that specifications to be separately delivered.
- Application circuit diagrams and circuit constants contained herein are shown as examples of standard use and operation. Please pay careful attention to the peripheral conditions when designing circuits and deciding upon circuit constants in the set.
- Any data, including, but not limited to application circuit diagrams information, described herein are intended only as illustrations of such devices and not as the specifications for such devices. ROHM CO.,LTD. disclaims any warranty that any use of such devices shall be free from infringement of any third party's intellectual property rights or other proprietary rights, and further, assumes no liability of whatsoever nature in the event of any such infringement, or arising from or connected with or related to the use of such devices.
- Upon the sale of any such devices, other than for buyer's right to use such devices itself, resell or otherwise dispose of the same, no express or implied right or license to practice or commercially exploit any intellectual property rights or other proprietary rights owned or controlled by
- ROHM CO., LTD. is granted to any such buyer.
- Products listed in this document are no antiradiation design.

The products listed in this document are designed to be used with ordinary electronic equipment or devices (such as audio visual equipment, office-automation equipment, communications devices, electrical appliances and electronic toys).

Should you intend to use these products with equipment or devices which require an extremely high level of reliability and the malfunction of which would directly endanger human life (such as medical instruments, transportation equipment, aerospace machinery, nuclear-reactor controllers, fuel controllers and other safety devices), please be sure to consult with our sales representative in advance.

About Export Control Order in Japan

Products described herein are the objects of controlled goods in Annex 1 (Item 16) of Export Trade Control Order in Japan.

In case of export from Japan, please confirm if it applies to "objective" criteria or an "informed" (by MITI clause) on the basis of "catch all controls for Non-Proliferation of Weapons of Mass Destruction.