



Dual-/Triple-/Quad-Voltage, Capacitor-Adjustable, Sequencing/Supervisory Circuits

General Description

The MAX16041/MAX16042/MAX16043 are dual-/triple-/quad-voltage monitors and sequencers that are offered in a small thin QFN package. These devices offer enormous design flexibility as they allow fixed and adjustable thresholds to be selected through logic inputs and provide sequence timing through small external capacitors. These versatile devices are ideal for use in a wide variety of multivoltage applications.

As the voltage at each monitored input exceeds its respective threshold, its corresponding output goes high after a propagation delay or a capacitor-set time delay. When a voltage falls below its threshold, its respective output goes low after a propagation delay. Each detector circuit also includes its own enable input, allowing the power-good outputs to be shut off independently. The independent output for each detector has an open-drain configuration capable of supporting voltages up to 28V, thereby allowing them to interface to shutdown and enable inputs of various DC-DC regulators. Each detector can operate independently as four separate supervisory circuits or can be daisy-chained to provide controlled power-supply sequencing.

The MAX16041/MAX16042/MAX16043 also include a push-pull reset function that deasserts only after all of the independently monitored voltages exceed their threshold. The reset timeout is internally fixed or can be adjusted externally. These devices are offered in a 4mm x 4mm TQFN package and are fully specified from -40°C to +125°C.

Applications

Multivoltage Systems
DC-DC Supplies
Servers/Workstations
Storage Systems
Networking/Telecommunication Equipment

Selector Guide

PART	MONITORED VOLTAGES	INDEPENDENT OUTPUTS	RESET OUTPUT
MAX16041	2	2 (Open-drain)	Push-pull
MAX16042	3	3 (Open-drain)	Push-pull
MAX16043	4	4 (Open-drain)	Push-pull

Features

- ◆ 2.2V to 28V Operating Voltage Range
- ◆ Fixed Thresholds for 3.3V, 2.5V, 1.8V, 1.5V, and 1.2V Systems
- ◆ 1.5% Accurate Adjustable Threshold Monitors Voltages Down to 0.5V
- ◆ 2.7% Accurate Fixed Thresholds Over Temperature
- ◆ Fixed (140ms min)/Capacitor-Adjustable Delay Timing
- ◆ Independent Open-Drain Outputs/Push-Pull RESET Output
- ◆ Enable Inputs for Each Monitored Voltage
- ◆ 9 Logic-Selectable Threshold Options
- ◆ Manual Reset and Tolerance Select (5%/10%) Inputs
- ◆ Small, 4mm x 4mm TQFN Package
- ◆ Fully Specified from -40°C to +125°C

Ordering Information

PART*	TEMP RANGE	PIN-PACKAGE	PKG CODE
MAX16041TE+	-40°C to +125°C	16 TQFN	T1644-4
MAX16042TP+	-40°C to +125°C	20 TQFN	T2044-3
MAX16043TG+	-40°C to +125°C	24 TQFN	T2444-4

+Denotes lead-free package.

*For tape and reel, add a "T" after the "+." All tape and reel orders are available in 2.5k increments.

Pin Configurations

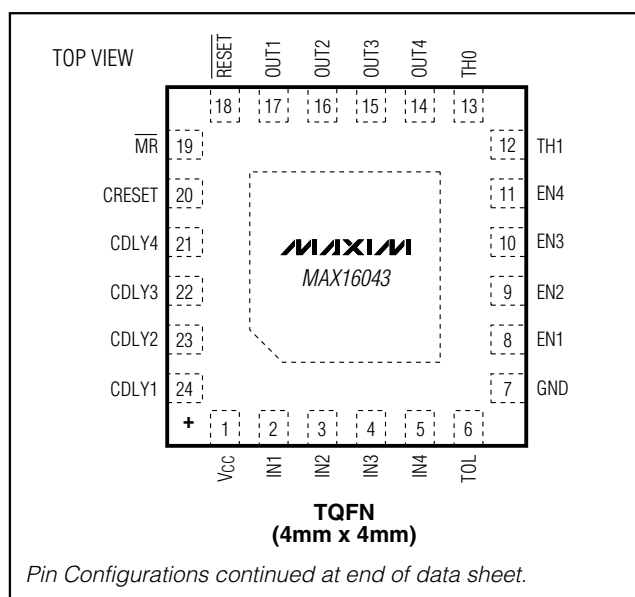

MAX16041/MAX16042/MAX16043



Dual-/Triple-/Quad-Voltage, Capacitor-Adjustable, Sequencing/Supervisory Circuits

ABSOLUTE MAXIMUM RATINGS

(All voltages referenced to GND.)

V _{CC}	-0.3V to +30V
EN1–EN4	-0.3V to (V _{CC} + 0.3V)
OUT1–OUT4	-0.3V to +30V
RESET.....	-0.3V to (V _{CC} + 0.3V)
IN1–IN4.....	-0.3V to (V _{CC} + 0.3V)
MR, TOL, TH1, TH0	-0.3V to (V _{CC} + 0.3V)
CDLY1–CDLY4.....	-0.3V to +6V
CRESET	-0.3V to (V _{CC} + 0.3V)
Input/Output Current (all pins).....	±20mA

Continuous Power Dissipation (T_A = +70°C)

16-Pin TQFN (derate 25mW/°C above +70°C)	2000mW
20-Pin TQFN (derate 25.6mW/°C above +70°C)	2051mW
24-Pin TQFN (derate 27.8mW/°C above +70°C)	2222mW
Operating Temperature Range	-40°C to +125°C
Storage Temperature Range	-65°C to +150°C
Junction Temperature.....	+150°C
Lead Temperature (soldering, 10s).....	+300°C

Stresses beyond those listed under “Absolute Maximum Ratings” may cause permanent damage to the device. These are stress ratings only, and functional operation of the device at these or any other conditions beyond those indicated in the operational sections of the specifications is not implied. Exposure to absolute maximum rating conditions for extended periods may affect device reliability.

ELECTRICAL CHARACTERISTICS

(V_{CC} = 2.2V to 28V, T_A = -40°C to +125°C, unless otherwise specified. Typical values are at V_{CC} = 3.3V and T_A = +25°C.) (Note 1)

PARAMETER	SYMBOL	CONDITIONS	MIN	TYP	MAX	UNITS
SUPPLY						
Operating Voltage Range	V _{CC}	(Note 2)	2.2		28.0	V
Undervoltage Lockout	UVLO	(Note 2)	1.8	1.9	2.0	V
Undervoltage-Lockout Hysteresis	UVLO _{HYST}	V _{CC} falling		50		mV
V _{CC} Supply Current	I _{CC}	All OUT _n and RESET at logic-high (IN _n current excluded)	V _{CC} = 3.3V	40	75	μA
			V _{CC} = 12V	47	75	
			V _{CC} = 28V	52	80	
INPUTS (IN_n)						
IN _n Thresholds (IN _n Falling)	V _{TH}	3.3V threshold, TOL = GND	2.970	3.052	3.135	V
		3.3V threshold, TOL = V _{CC}	2.805	2.888	2.970	
		2.5V threshold, TOL = GND	2.250	2.313	2.375	
		2.5V threshold, TOL = V _{CC}	2.125	2.187	2.250	
		1.8V threshold, TOL = GND	1.620	1.665	1.710	
		1.8V threshold, TOL = V _{CC}	1.530	1.575	1.620	
		1.5V threshold, TOL = GND	1.350	1.387	1.425	
		1.5V threshold, TOL = V _{CC}	1.275	1.312	1.350	
		1.2V threshold, TOL = GND	1.080	1.110	1.140	
Adjustable Threshold (IN _n Falling)	V _{TH}	TOL = GND	0.492	0.5	0.508	V
		TOL = V _{CC}	0.463	0.472	0.481	
IN _n Hysteresis (IN _n Rising)	V _{HYST}			0.5		%
IN _n Input Resistance		Fixed threshold	500	918		kΩ
IN _n Input Current	I _L	Adjustable threshold only (V _{IN_n} = 1V)	-100		+100	nA

Dual-/Triple-/Quad-Voltage, Capacitor-Adjustable, Sequencing/Supervisory Circuits

ELECTRICAL CHARACTERISTICS (continued)

($V_{CC} = 2.2V$ to $28V$, $T_A = -40^{\circ}C$ to $+125^{\circ}C$, unless otherwise specified. Typical values are at $V_{CC} = 3.3V$ and $T_A = +25^{\circ}C$.) (Note 1)

PARAMETER	SYMBOL	CONDITIONS	MIN	TYP	MAX	UNITS
CRESET AND CDLY_						
CRESET Threshold	$V_{TH-RESET}$	CRESET rising, $V_{CC} = 3.3V$	0.465	0.5	0.535	V
CRESET Charge Current	$I_{CH-RESET}$	$V_{CC} = 3.3V$	380	500	620	nA
CDLY_ Threshold	$V_{TH-CDLY}$	CDLY_ rising, $V_{CC} = 3.3V$	0.95	1	1.05	V
CDLY_ Charge Current	$I_{CH-CDLY}$	$V_{CC} = 3.3V$	200	250	300	nA
DIGITAL LOGIC INPUTS (EN_, MR, TOL, TH1, TH0)						
Input Low Voltage	V_{IL}				0.4	V
Input High Voltage	V_{IH}		1.4			V
TH1, TH0 Logic-Input Floating				0.6		V
TOL, TH1, TH0 Logic-Input Current		$V_{TOL}, V_{TH1}, V_{TH0} = GND$ or V_{CC}	-1		+1	μA
EN_ Input Leakage Current		$V_{EN_} = V_{CC}$ or GND	-100		+100	nA
MR Internal Pullup Current		$V_{CC} = 3.3V$	250	535	820	nA
OUTPUTS (OUT_, RESET)						
Output Low Voltage (Open-Drain or Push-Pull)	V_{OL}	$V_{CC} \geq 1.2V, I_{SINK} = 90\mu A$			0.3	V
		$V_{CC} \geq 2.25V, I_{SINK} = 0.5mA$			0.3	
		$V_{CC} \geq 4.5V, I_{SINK} = 1mA$			0.35	
Output High Voltage (Push-Pull)	V_{OH}	$V_{CC} \geq 3V, I_{SOURCE} = 500\mu A$	$0.8 \times V_{CC}$			V
		$V_{CC} \geq 4.5V, I_{SOURCE} = 800\mu A$	$0.8 \times V_{CC}$			
Output Leakage Current (Open-Drain)	I_{LKG}	Output not asserted low, $V_{OUT} = 28V$			1	μA
Reset Timeout Period	t_{RP}	CRESET = V_{CC} , $V_{CC} = 3.3V$	140	190	260	ms
		CRESET open		0.030		
TIMING						
IN_ to OUT_ Propagation Delay	t_{DELAY+}	IN_ rising, CDLY_ open		35		μs
	t_{DELAY-}	IN_ falling, CDLY_ open		20		
IN_ to RESET Propagation Delay	$t_{RST-DELAY}$	CRESET open, IN_ falling		35		μs
MR Minimum Input Pulse Width		(Note 3)	2			μs
EN_ or MR Glitch Rejection				280		ns
EN_ to OUT_ Delay	t_{OFF}	From device enabled to device disabled		3		μs
	t_{ON}	From device disabled to device enabled (CDLY_ open)		30		
MR to RESET Delay		MR falling		3		μs

Note 1: Devices are production tested at $T_A = +25^{\circ}C$. Limits over temperature are guaranteed by design.

Note 2: Operating below the UVLO causes all outputs to go low. The outputs are guaranteed to be in the correct state for V_{CC} down to 1.2V.

Note 3: To guarantee an assertion, the minimum input pulse width must be greater than $2\mu s$.

MAX16041/MAX16042/MAX16043

Dual-/Triple-/Quad-Voltage, Capacitor-Adjustable, Sequencing/Supervisory Circuits

Typical Operating Characteristics

($V_{CC} = 3.3V$, $T_A = +25^\circ C$, unless otherwise noted.)

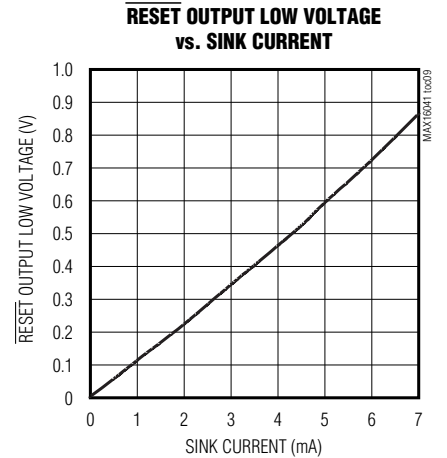
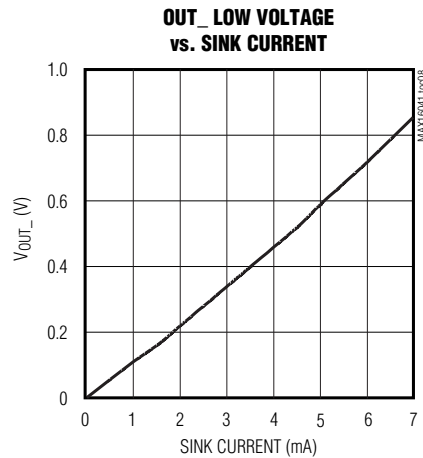
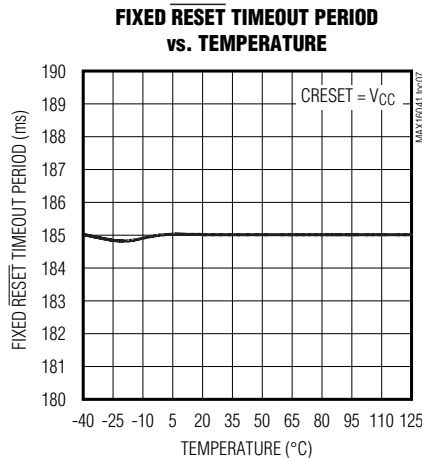
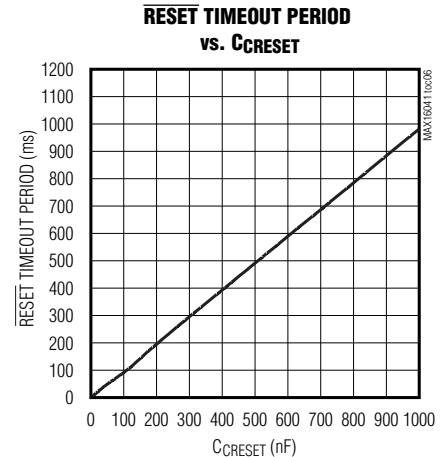
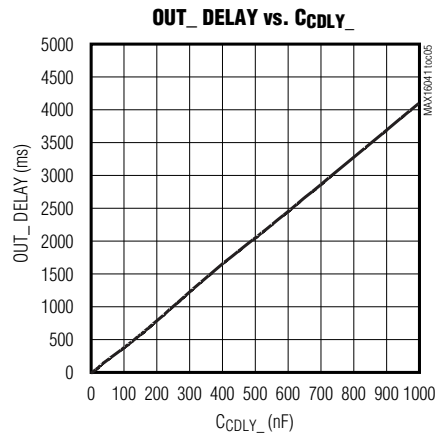
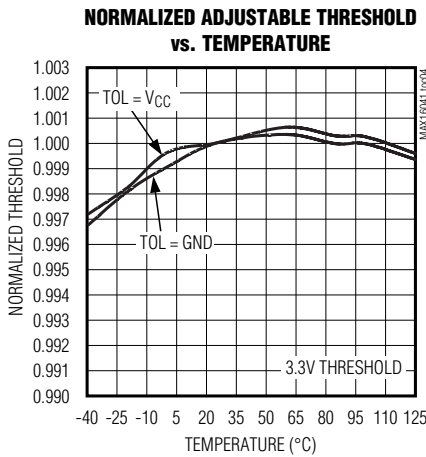
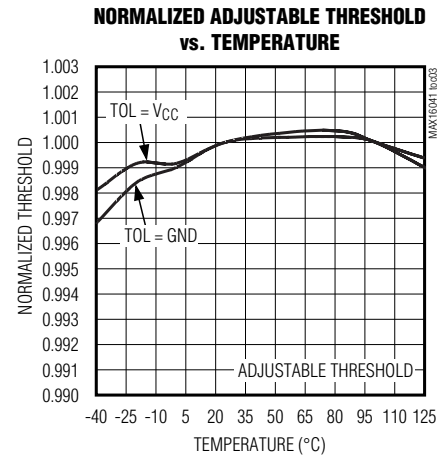
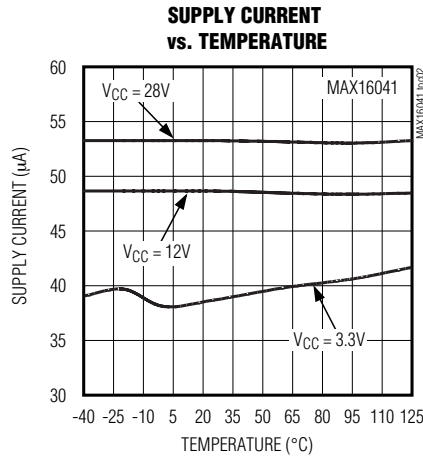
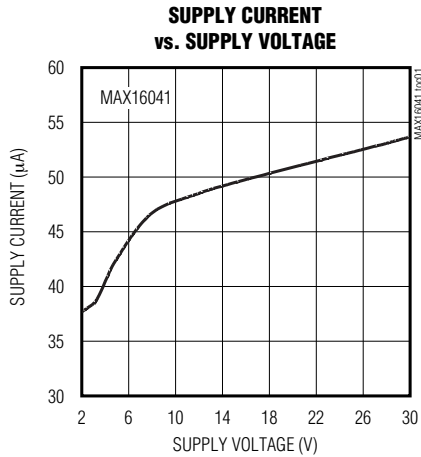

Dual-/Triple-/Quad-Voltage, Capacitor-Adjustable, Sequencing/Supervisory Circuits

Typical Operating Characteristics (continued)

($V_{CC} = 3.3V$, $T_A = +25^\circ C$, unless otherwise noted.)

MAX16041/MAX16042/MAX16043

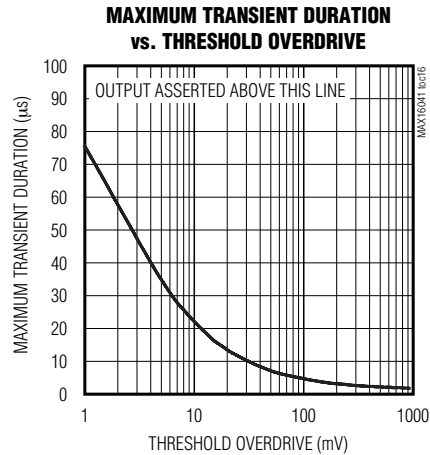
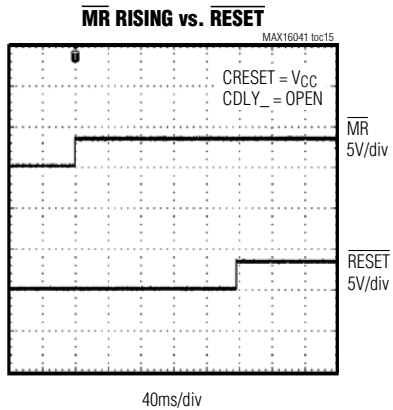
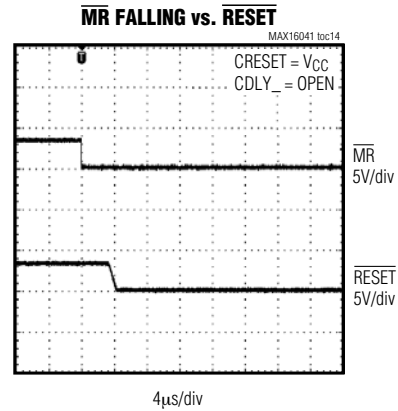
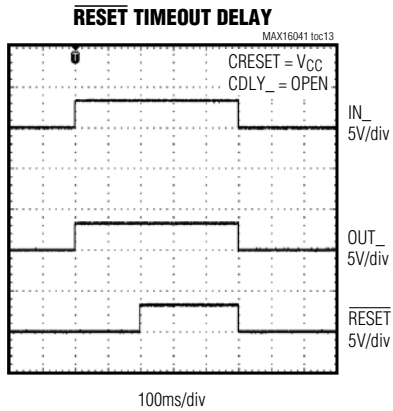
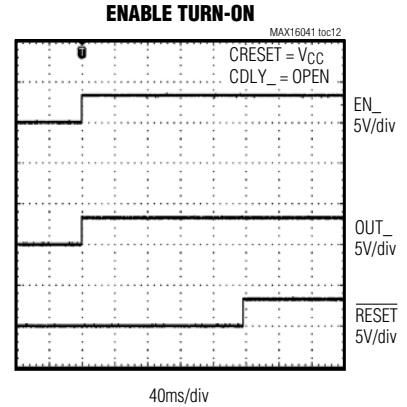
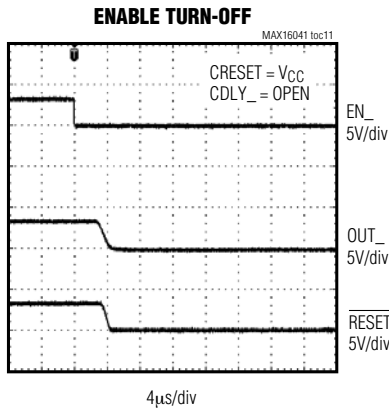
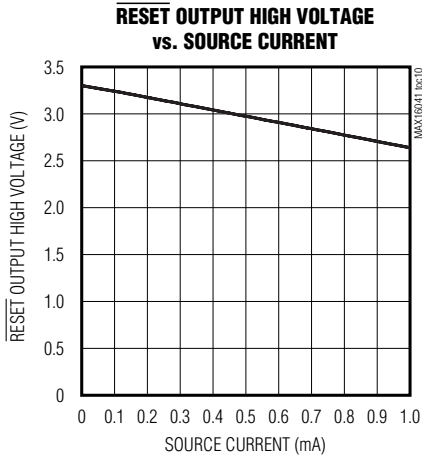

Dual-/Triple-/Quad-Voltage, Capacitor-Adjustable, Sequencing/Supervisory Circuits

Pin Description

PIN			NAME	FUNCTION
MAX16041	MAX16042	MAX16043		
1	1	1	V _{CC}	Supply Voltage Input. Connect a 2.2V to 28V supply voltage to power the device. All outputs are low when V _{CC} is below the UVLO. For noisy systems, bypass V _{CC} to GND with a 0.1μF capacitor.
2	2	2	IN1	Monitored Input 1. When the voltage at IN1 exceeds its threshold, OUT1 goes high after the capacitor-adjustable delay period. When the voltage at IN1 falls below its threshold, OUT1 goes low after a propagation delay.
3	3	3	IN2	Monitored Input 2. When the voltage at IN2 exceeds its threshold, OUT2 goes high after the capacitor-adjustable delay period. When the voltage at IN2 falls below its threshold, OUT2 goes low after a propagation delay.
—	4	4	IN3	Monitored Input 3. When the voltage at IN3 exceeds its threshold, OUT3 goes high after the capacitor-adjustable delay period. When the voltage at IN3 falls below its threshold, OUT3 goes low after a propagation delay.
—	—	5	IN4	Monitored Input 4. When the voltage at IN4 exceeds its threshold, OUT4 goes high after the capacitor-adjustable delay period. When the voltage at IN4 falls below its threshold, OUT4 goes low after a propagation delay.
4	5	6	TOL	Threshold Tolerance Input. Connect TOL to GND to select thresholds 5% below nominal. Connect TOL to V _{CC} to select thresholds 10% below nominal.
5	6	7	GND	Ground
6	7	8	EN1	Active-High Logic-Enable Input 1. Driving EN1 low causes OUT1 to go low regardless of the input voltage. Drive EN1 high to enable the monitoring comparator.
7	8	9	EN2	Active-High Logic-Enable Input 2. Driving EN2 low causes OUT2 to go low regardless of the input voltage. Drive EN2 high to enable the monitoring comparator.
—	9	10	EN3	Active-High Logic-Enable Input 3. Driving EN3 low causes OUT3 to go low regardless of the input voltage. Drive EN3 high to enable the monitoring comparator.
—	—	11	EN4	Active-High Logic-Enable Input 4. Driving EN4 low causes OUT4 to go low regardless of the input voltage. Drive EN4 high to enable the monitoring comparator.
8	10	12	TH1	Threshold Select Input 1. Connect TH1 to V _{CC} or GND, or leave it open to select the input-voltage threshold option in conjunction with TH0 (see Table 2).
9	11	13	TH0	Threshold Select Input 0. Connect TH0 to V _{CC} or GND, or leave it open to select the input-voltage threshold option in conjunction with TH1 (see Table 2).
—	—	14	OUT4	Output 4. When the voltage at IN4 is below its threshold or EN4 goes low, OUT4 goes low.
—	12	15	OUT3	Output 3. When the voltage at IN3 is below its threshold or EN3 goes low, OUT3 goes low.
10	13	16	OUT2	Output 2. When the voltage at IN2 is below its threshold or EN2 goes low, OUT2 goes low.

Dual-/Triple-/Quad-Voltage, Capacitor-Adjustable, Sequencing/Supervisory Circuits

Pin Description (continued)

PIN			NAME	FUNCTION
MAX16041	MAX16042	MAX16043		
11	14	17	OUT1	Output 1. When the voltage at IN1 is below its threshold or EN1 goes low, OUT1 goes low.
12	15	18	$\overline{\text{RESET}}$	Active-Low Reset Output. $\overline{\text{RESET}}$ asserts low when any of the monitored voltages (IN _n) falls below its respective threshold, any EN _n goes low, or $\overline{\text{MR}}$ is asserted. $\overline{\text{RESET}}$ remains asserted for the reset timeout period after all of the monitored voltages exceed their respective threshold, all EN _n are high, all OUT _n are high, and $\overline{\text{MR}}$ is deasserted.
13	16	19	$\overline{\text{MR}}$	Active-Low Manual Reset Input. Pull $\overline{\text{MR}}$ low to assert $\overline{\text{RESET}}$ low. $\overline{\text{RESET}}$ remains low for the reset timeout period after $\overline{\text{MR}}$ is deasserted (as long as all OUT _n are high).
14	17	20	CRESET	Capacitor-Adjustable Reset Delay Input. Connect an external capacitor from CRESET to GND to set the reset timeout period or connect to V _{CC} for the default 140ms minimum reset timeout period. Leave CRESET open for internal propagation delay.
—	—	21	CDLY4	Capacitor-Adjustable Delay Input 4. Connect an external capacitor from CDLY4 to GND to set the IN4 to OUT4 (and EN4 to OUT4) delay period. Leave CDLY4 open for internal propagation delay.
—	18	22	CDLY3	Capacitor-Adjustable Delay Input 3. Connect an external capacitor from CDLY3 to GND to set the IN3 to OUT3 (and EN3 to OUT3) delay period. Leave CDLY3 open for internal propagation delay.
15	19	23	CDLY2	Capacitor-Adjustable Delay Input 2. Connect an external capacitor from CDLY2 to GND to set the IN2 to OUT2 (and EN2 to OUT2) delay period. Leave CDLY2 open for internal propagation delay.
16	20	24	CDLY1	Capacitor-Adjustable Delay Input 1. Connect an external capacitor from CDLY1 to GND to set the IN1 to OUT1 (and EN1 to OUT1) delay period. Leave CDLY1 open for internal propagation delay.
—	—	—	EP	Exposed Pad. EP is internally connected to GND. Connect EP to the ground plane.

Detailed Description

The MAX16041/MAX16042/MAX16043 are low-voltage, accurate, dual-/triple-/quad-voltage microprocessor (μP) supervisors in a small TQFN package. These devices provide supervisory and sequencing functions for complex multivoltage systems. The MAX16041 monitors two voltages, the MAX16042 monitors three voltages, and the MAX16043 monitors four voltages.

The MAX16041/MAX16042/MAX16043 offer independent outputs and enable functions for each monitored voltage. This configuration allows the device to operate as four separate supervisory circuits or be daisy-chained together to allow controlled sequencing of power supplies during power-up initialization. When all of the monitored

voltages exceed their respective thresholds, an independent reset output deasserts to allow the system processor to operate.

These devices offer enormous flexibility as there are nine threshold options that are selected through two threshold-select logic inputs. Each monitor circuit also offers an independent enable input to allow both digital and analog control of each monitor output. A tolerance select input allows these devices to be used in systems requiring 5% or 10% power-supply tolerances. In addition, the time delays and reset timeout can be adjusted using small capacitors. There is also a fixed 140ms minimum reset timeout feature.

Dual-/Triple-/Quad-Voltage, Capacitor-Adjustable, Sequencing/Supervisory Circuits

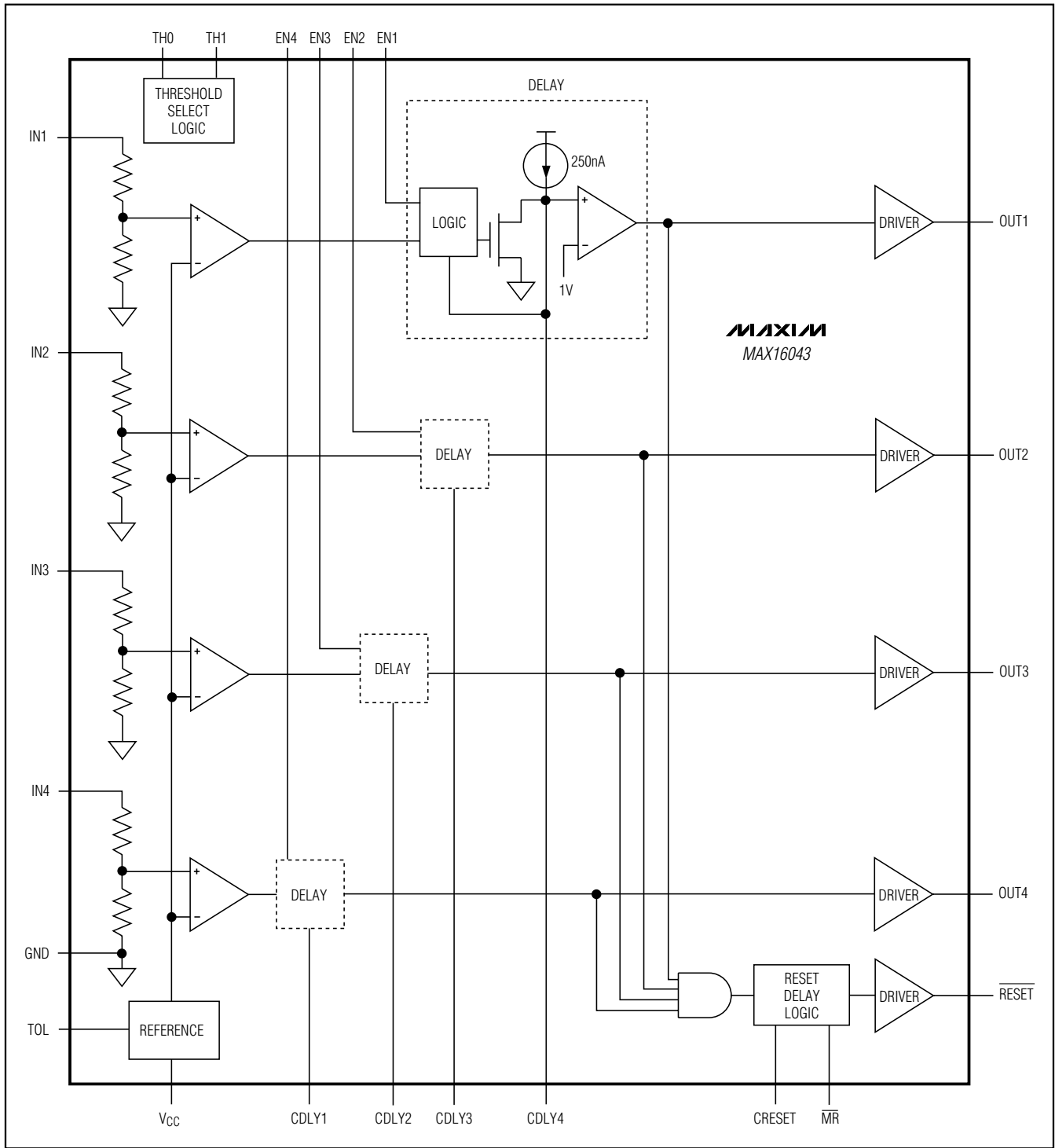

Figure 1. MAX16043 Simplified Functional Diagram

Dual-/Triple-/Quad-Voltage, Capacitor-Adjustable, Sequencing/Supervisory Circuits

MAX16041/MAX16042/MAX16043

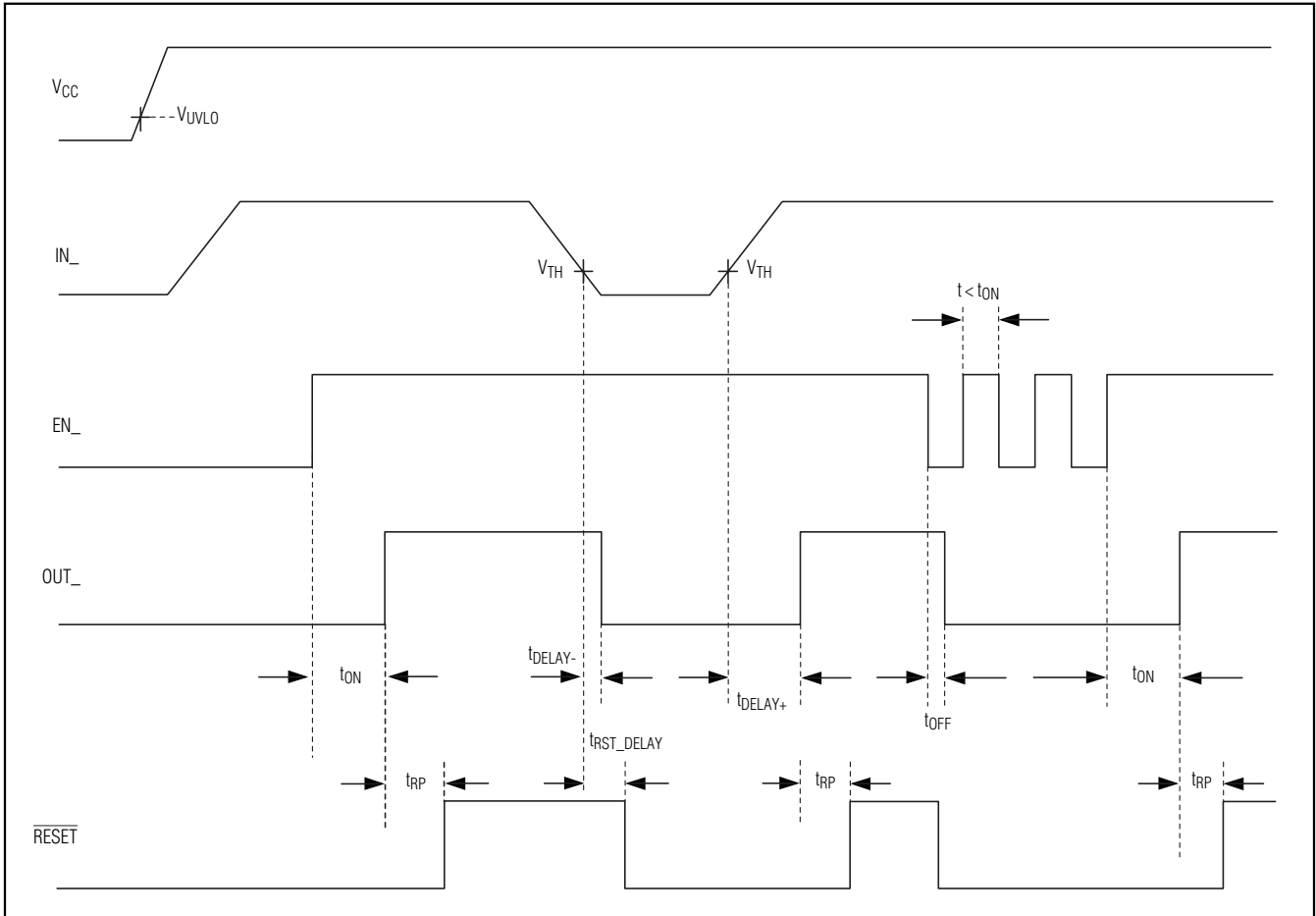

Figure 2. Timing Diagram (CDLY_ Open)

Applications Information

Tolerance

The MAX16041/MAX16042/MAX16043 feature a pin-selectable threshold tolerance. Connect TOL to GND to select the thresholds 5% below the nominal value. Connect TOL to VCC to select the threshold tolerance 10% below the nominal voltage. Do not leave TOL unconnected.

Adjustable Input

These devices offer several monitoring options with both fixed and/or adjustable reset thresholds (see Table 2). For the adjustable threshold inputs, the threshold voltage (V_{TH}) at each adjustable $IN_$ input is typically 0.5V (TOL = GND) or 0.472V (TOL = VCC). To monitor a voltage V_{INTH} , connect a resistive divider network to the circuit as

shown in Figure 3 and use the following equation to calculate the threshold voltage:

$$V_{INTH} = V_{TH} \times \left(1 + \frac{R1}{R2}\right)$$

Choosing the proper external resistors is a balance between accuracy and power use. The input to the voltage monitor is a high-impedance input with a small 100nA leakage current. This leakage current contributes to the overall error of the threshold voltage where the output is asserted. This induced error is proportional to the value of the resistors used to set the threshold. With lower value resistors, this error is reduced, but the amount of power consumed in the resistors increases.

Dual-/Triple-/Quad-Voltage, Capacitor-Adjustable, Sequencing/Supervisory Circuits

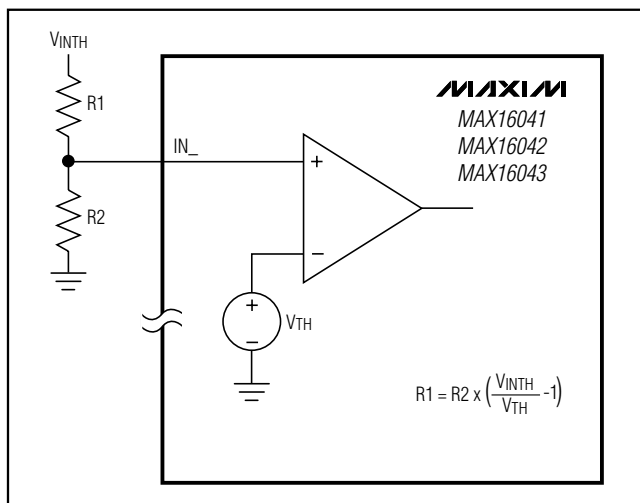

Figure 3. Setting the Adjustable Input

The following equation is provided to help estimate the value of the resistors based on the amount of acceptable error:

$$R1 = \frac{e_A \times V_{INTH}}{I_L}$$

where e_A is the fraction of the maximum acceptable absolute resistive divider error attributable to the input leakage current (use 0.01 for $\pm 1\%$), V_{INTH} is the voltage at which the output ($OUT_$) should assert, and I_L is the worst-case $IN_$ leakage current (see the *Electrical Characteristics*). Calculate $R2$ as follows:

$$R2 = \frac{V_{TH} \times R1}{V_{INTH} - V_{TH}}$$

Unused Inputs

Connect any unused $IN_$ and $EN_$ inputs to V_{CC} .

OUT_ Output

The MAX16041/MAX16042/MAX16043 feature open-drain outputs. An $OUT_$ goes low when its respective $IN_$ input voltage drops below its specified threshold or when its $EN_$ goes low (see Table 1). $OUT_$ goes high when $EN_$ is high and $V_{IN_}$ is above its threshold after a time delay. Open-drain outputs require an external pullup resistor to any voltage from 0 to 28V.

Table 1. Output State*

$EN_$	$IN_$	$OUT_$
Low	$V_{IN_} < V_{TH}$	Low
High	$V_{IN_} < V_{TH}$	Low
Low	$V_{IN_} > V_{TH}$	Low
High	$V_{IN_} > V_{TH}$	$OUT_ =$ high impedance

*When V_{CC} falls below the UVLO, all outputs go low regardless of the state of $EN_$ and $V_{IN_}$. The outputs are guaranteed to be in the correct state for V_{CC} down to 1.2V.

Table 2. Input-Voltage Threshold Selector

TH1/TH0 LOGIC	IN1 (ALL VERSIONS) (V)	IN2 (ALL VERSIONS) (V)	IN3 (MAX16042) (V)	IN4 (MAX16043) (V)
Low/Low	3.3	2.5	1.8	1.5
Low/High	3.3	1.8	Adj	Adj
Low/Open	3.3	1.5	Adj	Adj
High/Low	3.3	1.2	1.8	2.5
High/High	2.5	1.8	Adj	Adj
High/Open	3.3	Adj	2.5	Adj
Open/Low	3.3	Adj	Adj	Adj
Open/High	2.5	Adj	Adj	Adj
Open/Open	Adj	Adj	Adj	Adj

RESET Output

\overline{RESET} asserts low when any of the monitored voltages ($IN_$) falls below its respective threshold, any $EN_$ goes low, or \overline{MR} is asserted. \overline{RESET} remains asserted for the reset timeout period after all of the monitored voltages exceed their respective thresholds, all $EN_$ are high, all $OUT_$ are high, and \overline{MR} is deasserted. All devices have a push-pull, active-low reset output.

Dual-/Triple-/Quad-Voltage, Capacitor-Adjustable, Sequencing/Supervisory Circuits

Adjustable Reset Timeout Period (CRESET)

All of these parts offer an internally fixed reset timeout (140ms min) by connecting CRESET to VCC. The reset timeout can also be adjusted by connecting a capacitor from CRESET to GND. When the voltage at CRESET reaches 0.5V, RESET goes high. When RESET goes high, CRESET is immediately held low.

Calculate the reset timeout period as follows:

$$t_{RP} = \frac{V_{TH-RESET}}{I_{CH-RESET}} \times C_{CRESET} + 30 \times 10^{-6}$$

where $V_{TH-RESET}$ is 0.5V, $I_{CH-RESET}$ is 0.5μA, t_{RP} is in seconds, and C_{CRESET} is in Farads. To ensure timing accuracy and proper operation, minimize leakage at C_{CRESET} .

Adjustable Delay (CDLY_)

When V_{IN} rises above V_{TH} with EN_+ high, the internal 250nA current source begins charging an external capacitor connected from $CDLY_+$ to GND. When the voltage at $CDLY_+$ reaches 1V, OUT_+ goes high. When OUT_+ goes high, $CDLY_+$ is immediately held low. Adjust the delay (t_{DELAY}) from when V_{IN} rises above V_{TH} (with EN_+ high) to OUT_+ going high according to the equation:

$$t_{DELAY} = \frac{V_{TH-CDLY}}{I_{CH-CDLY}} \times C_{CDLY} + 35 \times 10^{-6}$$

where $V_{TH-CDLY}$ is 1V, $I_{CH-CDLY}$ is 0.25μA, C_{CDLY} is in Farads, and t_{DELAY} is in seconds. To ensure timing accuracy and proper operation, minimize leakage at $CDLY_+$.

Manual-Reset Input (MR)

Many μP-based products require manual-reset capability, allowing the operator, a test technician, or external logic circuitry to initiate a reset. A logic-low on MR asserts RESET low. RESET remains asserted while MR is low and during the reset timeout period (140ms fixed or capacitor adjustable) after MR returns high. The MR input has a 500nA internal pullup, so it can be left unconnected, if not used. MR can be driven with TTL or CMOS logic levels, or with open-drain/collector outputs.

Connect a normally open momentary switch from MR to GND to create a manual-reset function. External debounce circuitry is not required. If MR is driven from long cables or if the device is used in a noisy environment, connect a 0.1μF capacitor from MR to GND to provide additional noise immunity.

Pullup Resistor Values

The exact value of the pullup resistors for the open-drain outputs is not critical, but some consideration should be made to ensure the proper logic levels when the device is sinking current. For example, if $V_{CC} = 2.25V$ and the pullup voltage is 28V, keep the sink current less than 0.5mA as shown in the *Electrical Characteristics*. As a result, the pullup resistor should be greater than 56kΩ. For a 12V pullup, the resistor should be larger than 24kΩ. Note that the ability to sink current is dependent on the V_{CC} supply voltage.

Power-Supply Bypassing

The device operates with a V_{CC} supply voltage from 2.2V to 28V. When V_{CC} falls below the UVLO threshold, all the outputs go low and stay low until V_{CC} falls below 1.2V. For noisy systems or fast rising transients on V_{CC} , connect a 0.1μF ceramic capacitor from V_{CC} to GND as close to the device as possible to provide better noise and transient immunity.

Ensuring Valid Reset Output with Vcc Down to 0V

When V_{CC} falls below 1.2V, the ability for the output to sink current decreases. To ensure a valid output as V_{CC} falls to 0V, connect a 100kΩ resistor from RESET to GND.

Typical Application Circuits

Figures 4 and 5 show typical applications for the MAX16041/MAX16042/MAX16043. In high-power applications, using an n-channel device reduces the loss across the MOSFETs as it offers a lower drain-to-source on-resistance. However, an n-channel MOSFET requires a sufficient V_{GS} voltage to fully enhance it for a low R_{DS_ON} . The application in Figure 4 shows the MAX16042 configured in a multiple-output sequencing application. Figure 5 shows the MAX16043 in a power-supply sequencing application using n-channel MOSFETs.

Dual-/Triple-/Quad-Voltage, Capacitor-Adjustable, Sequencing/Supervisory Circuits

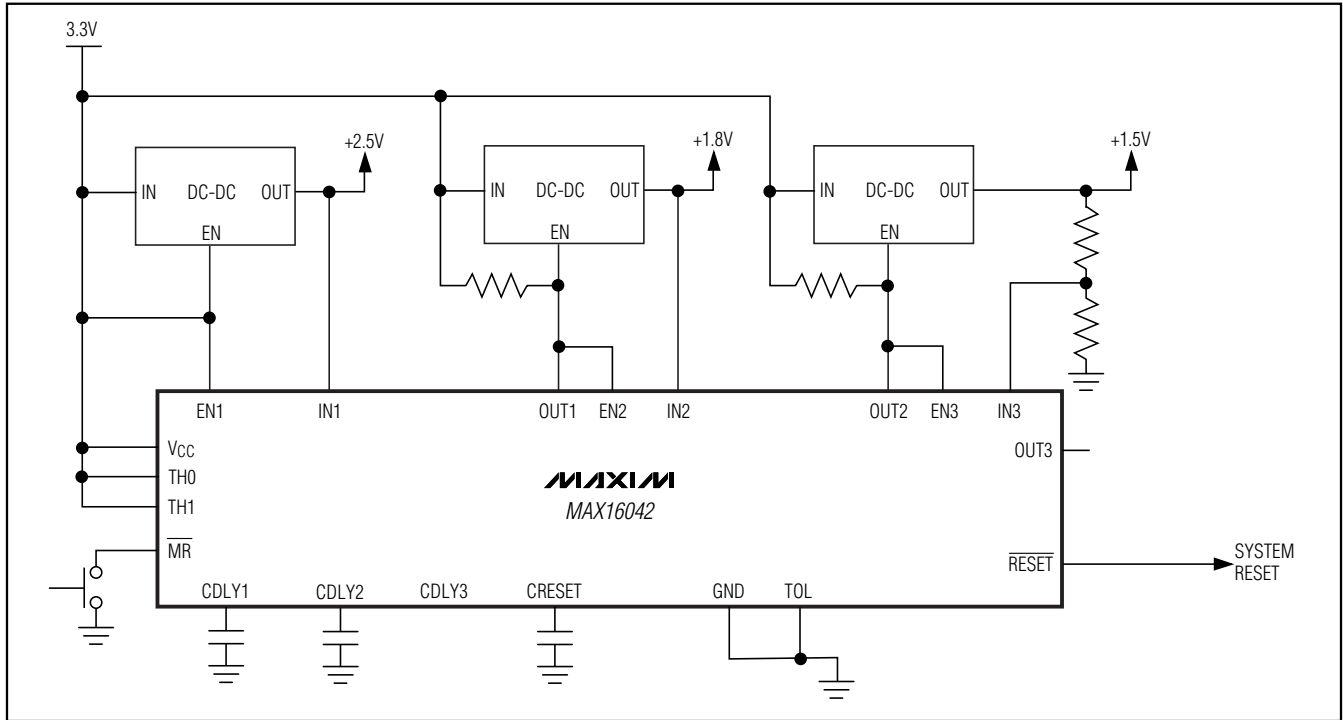

Figure 4. Sequencing Multiple-Voltage System

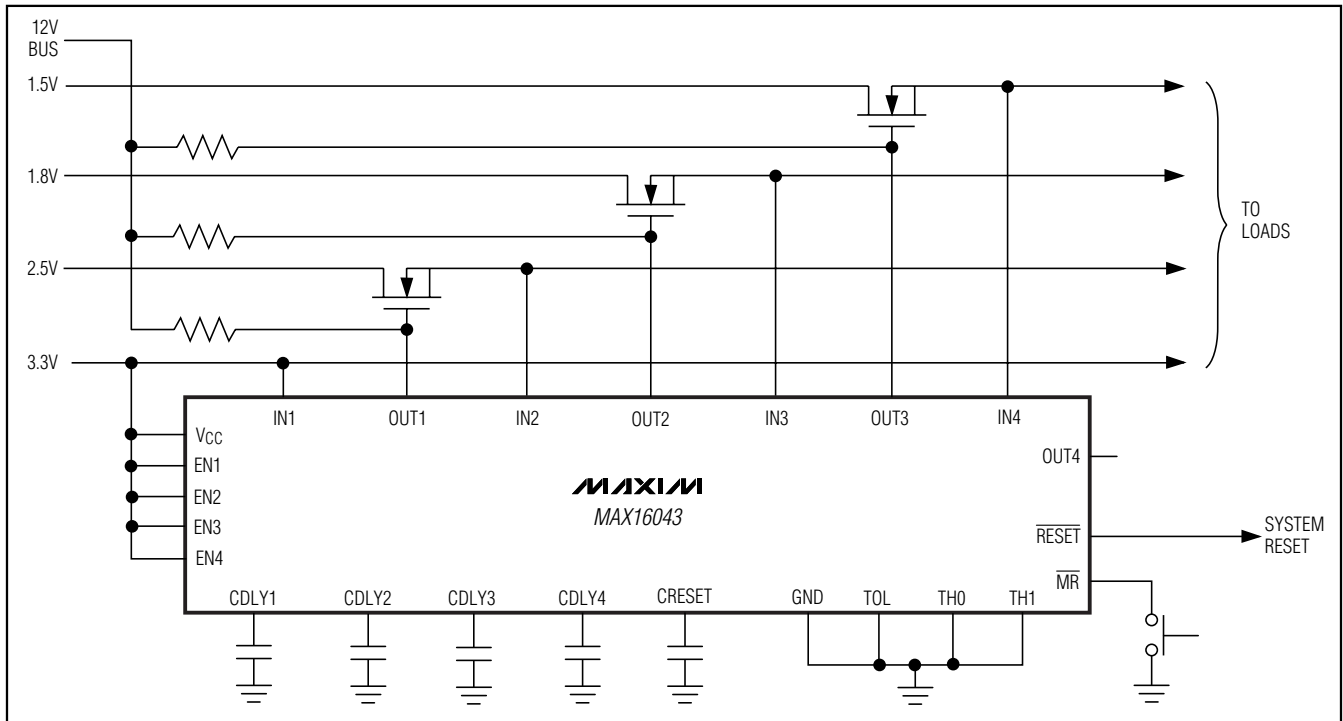
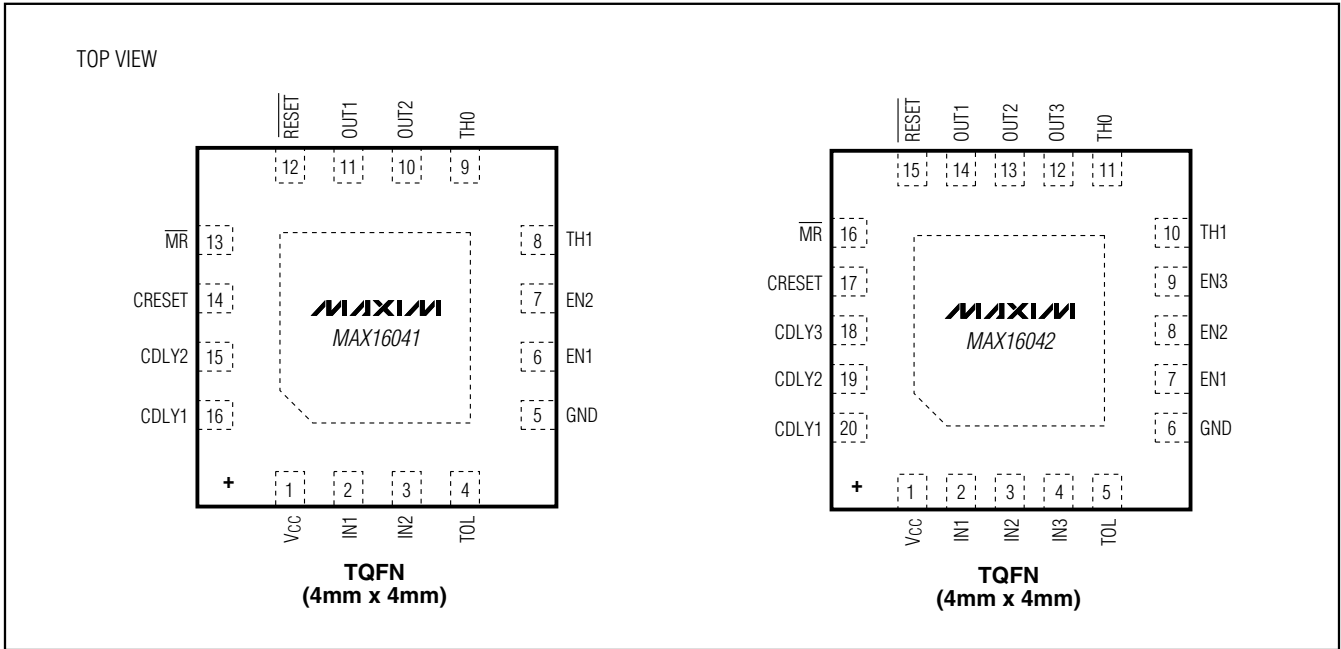

Figure 5. Multiple-Voltage Sequencing Using n-Channel FETs

Dual-/Triple-/Quad-Voltage, Capacitor-Adjustable, Sequencing/Supervisory Circuits

Pin Configurations (continued)

MAX16041/MAX16042/MAX16043



Chip Information

PROCESS: BICMOS

Dual-/Triple-/Quad-Voltage, Capacitor-Adjustable, Sequencing/Supervisory Circuits

Package Information

(The package drawing(s) in this data sheet may not reflect the most current specifications. For the latest package outline information go to www.maxim-ic.com/packages.)

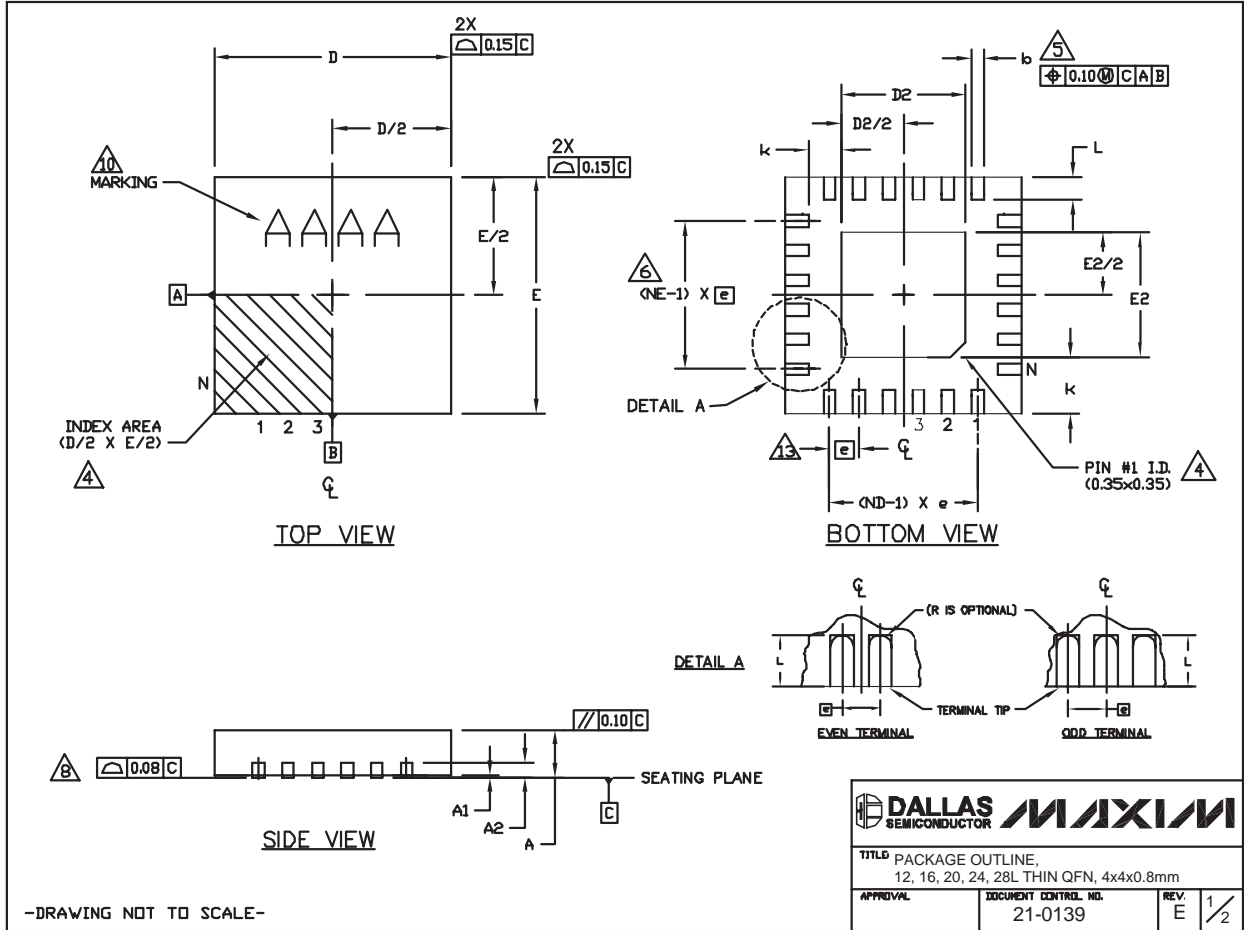

Dual-/Triple-/Quad-Voltage, Capacitor-Adjustable, Sequencing/Supervisory Circuits

Package Information (continued)

(The package drawing(s) in this data sheet may not reflect the most current specifications. For the latest package outline information go to www.maxim-ic.com/packages.)

MAX16041/MAX16042/MAX16043

COMMON DIMENSIONS														EXPOSED PAD VARIATIONS										
PKG	12L 4x4			16L 4x4			20L 4x4			24L 4x4			28L 4x4			PKG. CODES	D2			E2			DOWN BONDS ALLOWED	
REF.	MIN.	NDM.	MAX.	MIN.	NDM.	MAX.	MIN.	NDM.	MAX.	MIN.	NDM.	MAX.	MIN.	NDM.	MAX.		MIN.	NDM.	MAX.	MIN.	NDM.	MAX.		
A	0.70	0.75	0.80	0.70	0.75	0.80	0.70	0.75	0.80	0.70	0.75	0.80	0.70	0.75	0.80	T1244-3	1.95	2.10	2.25	1.95	2.10	2.25	YES	
A1	0.0	0.02	0.05	0.0	0.02	0.05	0.0	0.02	0.05	0.0	0.02	0.05	0.0	0.02	0.05	T1244-4	1.95	2.10	2.25	1.95	2.10	2.25	NO	
A2	0.20 REF			0.20 REF			0.20 REF			0.20 REF			0.20 REF			T1644-3	1.95	2.10	2.25	1.95	2.10	2.25	YES	
b	0.25	0.30	0.35	0.25	0.30	0.35	0.20	0.25	0.30	0.18	0.23	0.30	0.15	0.20	0.25	T1644-4	1.95	2.10	2.25	1.95	2.10	2.25	NO	
D	3.90	4.00	4.10	3.90	4.00	4.10	3.90	4.00	4.10	3.90	4.00	4.10	3.90	4.00	4.10	T2044-2	1.95	2.10	2.25	1.95	2.10	2.25	YES	
E	3.90	4.00	4.10	3.90	4.00	4.10	3.90	4.00	4.10	3.90	4.00	4.10	3.90	4.00	4.10	T2044-3	1.95	2.10	2.25	1.95	2.10	2.25	NO	
e	0.80 BSC.			0.65 BSC.			0.50 BSC.			0.50 BSC.			0.40 BSC.			T2444-2	1.95	2.10	2.25	1.95	2.10	2.25	YES	
k	0.25	-	-	0.25	-	-	0.25	-	-	0.25	-	-	0.25	-	-	T2444-3	2.45	2.60	2.63	2.45	2.60	2.63	YES	
L	0.45	0.55	0.65	0.45	0.55	0.65	0.45	0.55	0.65	0.30	0.40	0.50	0.30	0.40	0.50	T2444-4	2.45	2.60	2.63	2.45	2.60	2.63	NO	
N	12			16			20			24			28			T2844-1	2.50	2.60	2.70	2.50	2.60	2.70	NO	
ND	3			4			5			6			7											
NE	3			4			5			6			7											
JEDEC Var.	VGG3			VGGC			WGGD-1			WGGD-2			WGGE											

NOTES:

- DIMENSIONING & TOLERANCING CONFORM TO ASME Y14.5M-1994.
- ALL DIMENSIONS ARE IN MILLIMETERS. ANGLES ARE IN DEGREES.
- N IS THE TOTAL NUMBER OF TERMINALS.

 THE TERMINAL #1 IDENTIFIER AND TERMINAL NUMBERING CONVENTION SHALL CONFORM TO JEDEC 95-1 SP-012. DETAILS OF TERMINAL #1 IDENTIFIER ARE OPTIONAL, BUT MUST BE LOCATED WITHIN THE ZONE INDICATED. THE TERMINAL #1 IDENTIFIER MAY BE EITHER A MOLD OR MARKED FEATURE.

 DIMENSION b APPLIES TO METALIZED TERMINAL AND IS MEASURED BETWEEN 0.25 mm AND 0.30 mm FROM TERMINAL TIP.

 ND AND NE REFER TO THE NUMBER OF TERMINALS ON EACH D AND E SIDE RESPECTIVELY.

 DEPOPULATION IS POSSIBLE IN A SYMMETRICAL FASHION.

 COPLANARITY APPLIES TO THE EXPOSED HEAT SINK SLUG AS WELL AS THE TERMINALS.

 DRAWING CONFORMS TO JEDEC MO220, EXCEPT FOR T2444-3, T2444-4 AND T2844-1.

 MARKING IS FOR PACKAGE ORIENTATION REFERENCE ONLY.

 COPLANARITY SHALL NOT EXCEED 0.08mm

 WARPAGE SHALL NOT EXCEED 0.10mm

 LEAD CENTERLINES TO BE AT TRUE POSITION AS DEFINED BY BASIC DIMENSION "e", ±0.05.

 NUMBER OF LEADS SHOWN ARE FOR REFERENCE ONLY

-DRAWING NOT TO SCALE-

			
TITLED PACKAGE OUTLINE, 12, 16, 20, 24, 28L THIN QFN, 4x4x0.8mm			
APPROVAL	DOCUMENT CONTROL NO. 21-0139	REV. E	2/2

Maxim cannot assume responsibility for use of any circuitry other than circuitry entirely embodied in a Maxim product. No circuit patent licenses are implied. Maxim reserves the right to change the circuitry and specifications without notice at any time.

Maxim Integrated Products, 120 San Gabriel Drive, Sunnyvale, CA 94086 408-737-7600 _____ 15