



GaAs MMIC REFLECTIVE SPDT SWITCH, 0.1 - 50 GHz

Typical Applications

The HMC986 is ideal for:

- Wideband Switching Matrices
- High Speed Data Infrastructure
- Military Comms, RADAR, and ECM
- Test and Measurement Equipment
- Jamming and EW Subsystems

Features

- Wideband Performance: 0.1 to 50 GHz
- Low Insertion Loss: 1.9 dB at 40 GHz
- High Isolation: 31 dB at 40 GHz
- Fast Switching Speed: 10 ns
- Compact Die Size: 0.98 x 0.75 x 0.1 mm

Functional Diagram

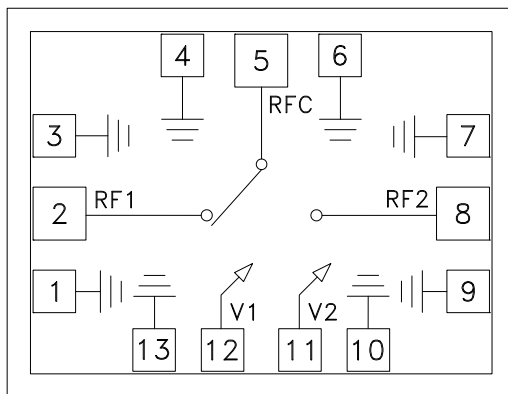

General Description

The HMC986 is a wideband GaAs pHEMT MMIC Single Pole Double Throw (SPDT) switch die. This tiny switch employs a reflective topology and is controlled with two complementary inputs of 0/-3V to 0/-5V. With an input signal at 40 GHz, the HMC986 exhibits 20 dB return loss, 31 dB isolation, and only 1.9 dB insertion loss. The combination of wideband performance and fast switching speed make this switch ideal for test equipment, switching matrices, and electronic warfare (EW) applications. RF performance is independent of high level control voltages, and is shown at both -3V and -5V for completeness.

Electrical Specifications, $T_A = +25^\circ\text{C}$, With 0/-3V to -5V Control, 50 Ohm System

Parameter	Frequency	Min.	Typ.	Max.	Units
Insertion Loss	0.1 - 18 GHz		1.7	2.3	dB
	18 - 40 GHz		1.9	2.5	dB
	40 - 50 GHz		2.2	2.8	dB
Isolation	0.1 - 18 GHz	30	36		dB
	18 - 40 GHz	25	32		dB
	40 - 50 GHz	22	28		dB
Return Loss	"On State"		20		dB
Input Power for 0.1 dB Compression	0.1 - 2 GHz		5		dBm
	2 - 50 GHz		21		dBm
Input Power for 1.0 dB Compression	0.1 - 2 GHz		10		dBm
	2 - 50 GHz	22	25		dBm
Input Third Order Intercept (Two-Tone Input Power = 0 dBm Each Tone, 1 MHz Tone Separation)	0.1 - 2 GHz		20		dBm
	2 - 50 GHz		40		dBm
Switching Characteristics tRISE, tFALL (10/90% RF)	0.1 - 50 GHz		1		ns
		tON, tOFF (50% CTL to 10/90% RF)		10	

Information furnished by Analog Devices is believed to be accurate and reliable. However, no responsibility is assumed by Analog Devices for its use, nor for any infringements of patents or other rights of third parties that may result from its use. Specifications subject to change without notice. No license is granted by implication or otherwise under any patent or patent rights of Analog Devices. Trademarks and registered trademarks are the property of their respective owners.

For price, delivery, and to place orders: Analog Devices, Inc., One Technology Way, P.O. Box 9106, Norwood, MA 02062-9106
Phone: 781-329-4700 • Order online at www.analog.com
Application Support: Phone: 1-800-ANALOG-D



**GaAs MMIC REFLECTIVE
SPDT SWITCH, 0.1 - 50 GHz**

Insertion Loss @-5V

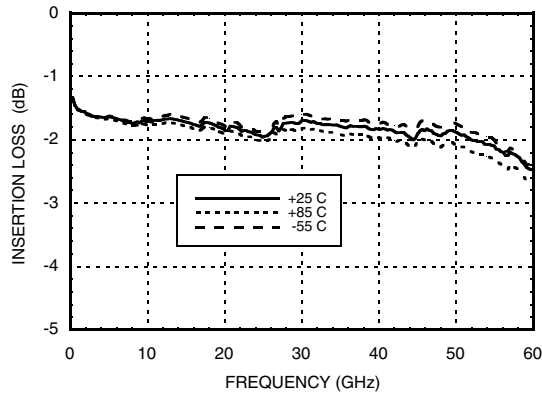

Insertion Loss @-3V

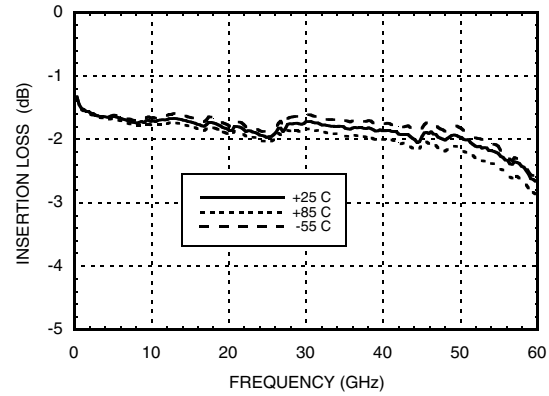

Isolation @-5V

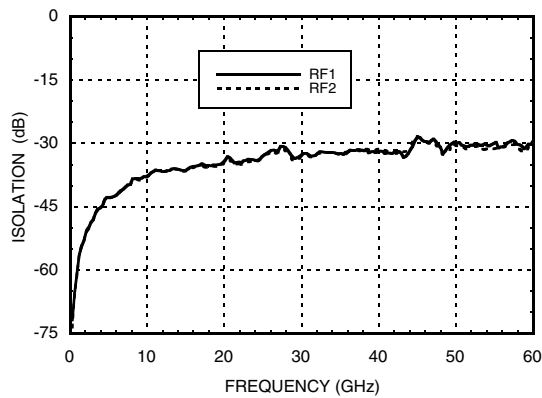

Isolation @-3V

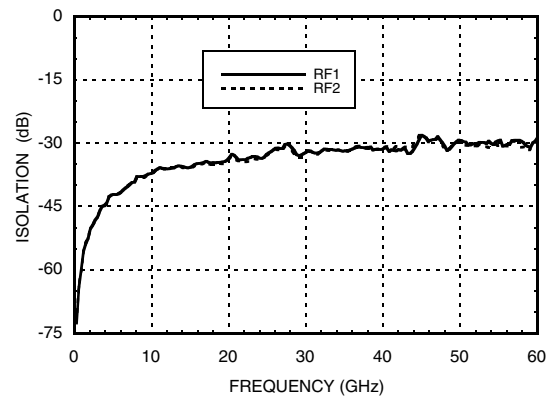

Return Loss @-5V

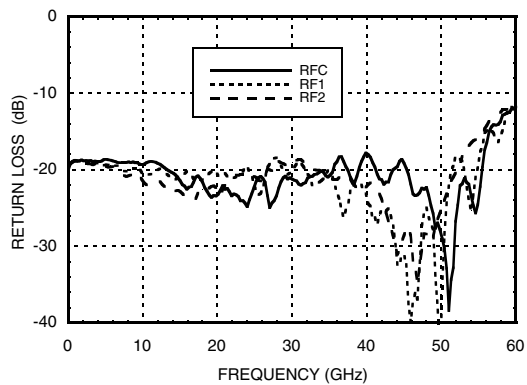

Return Loss @-3V

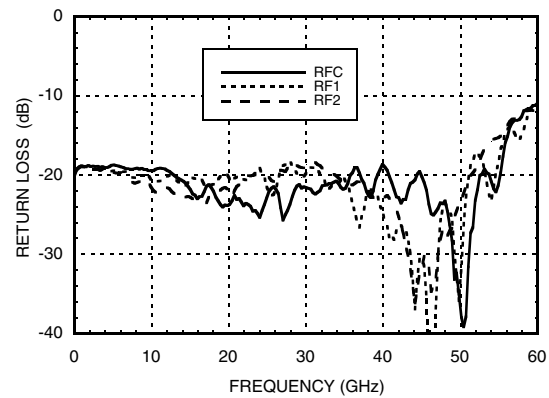



GaAs MMIC REFLECTIVE SPDT SWITCH, 0.1 - 50 GHz

SWITCHES - CHIP

Input Power for 0.1 dB Compression @-5V

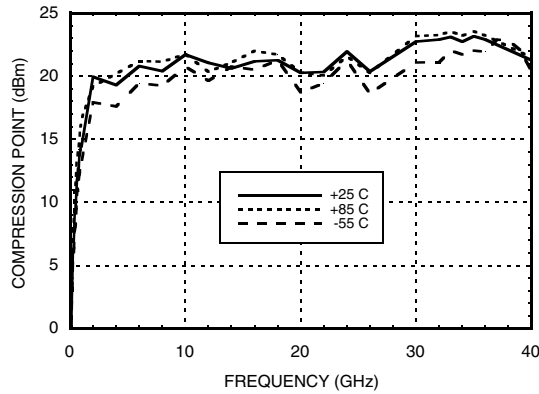

Input Power for 0.1 dB Compression @-3V

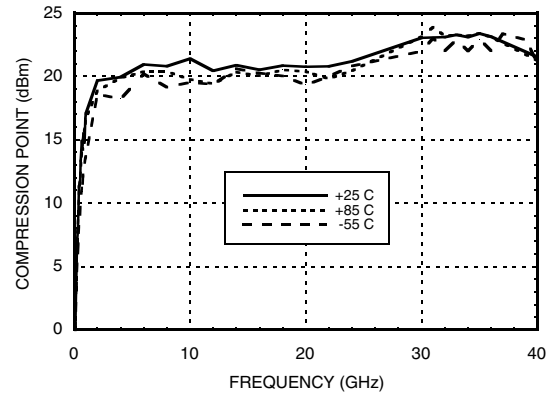

Input Power for 0.1 dB Compression @-5V (Low Frequency Detail)

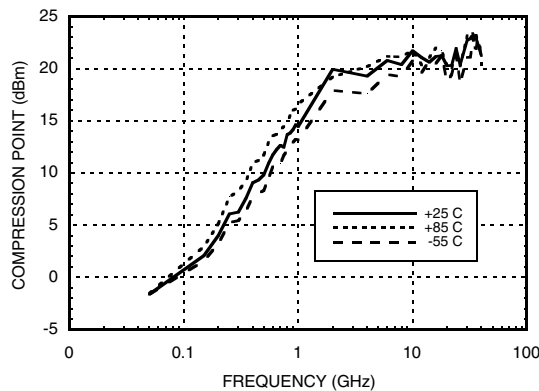

Input Power for 0.1 dB Compression @-3V (Low Frequency Detail)

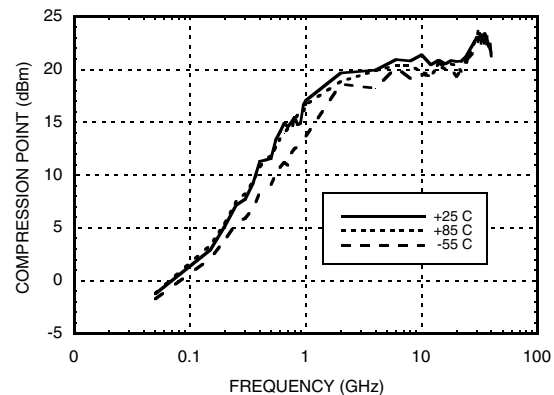

Input Power for 1.0 dB Compression @-5V (Low Frequency Detail)

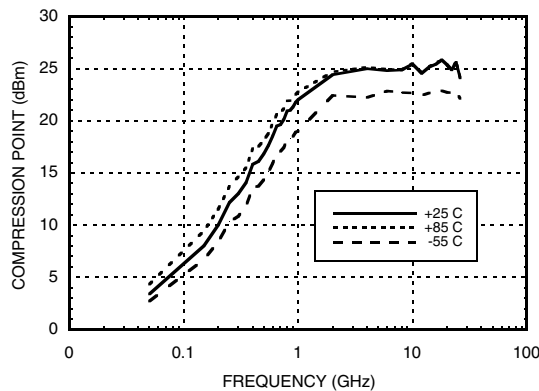

Input Power for 1.0 dB Compression @-3V (Low Frequency Detail)

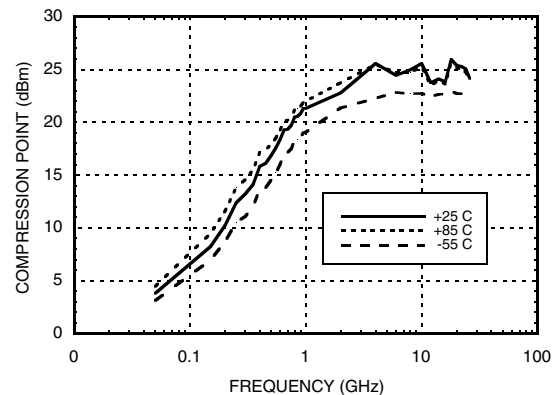

Information furnished by Analog Devices is believed to be accurate and reliable. However, no responsibility is assumed by Analog Devices for its use, nor for any infringements of patents or other rights of third parties that may result from its use. Specifications subject to change without notice. No license is granted by implication or otherwise under any patent or patent rights of Analog Devices. Trademarks and registered trademarks are the property of their respective owners.

For price, delivery, and to place orders: Analog Devices, Inc., One Technology Way, P.O. Box 9106, Norwood, MA 02062-9106 Phone: 781-329-4700 • Order online at www.analog.com Application Support: Phone: 1-800-ANALOG-D



GaAs MMIC REFLECTIVE SPDT SWITCH, 0.1 - 50 GHz

Input Third Order Intercept Point @-5V

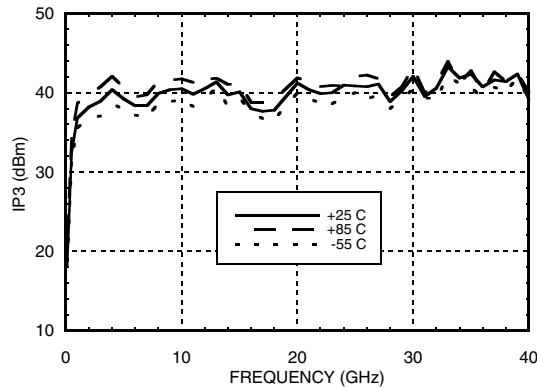

Input Third Order Intercept Point @-3V

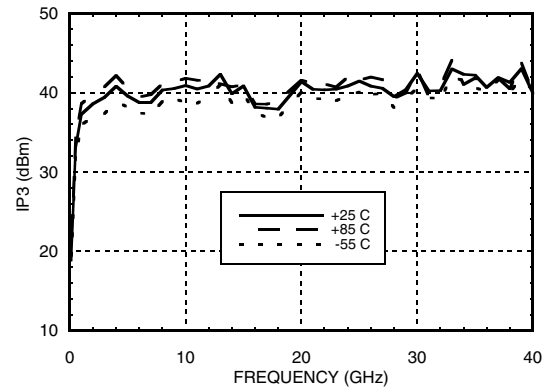

Input Third Order Intercept Point @-5V (Low Frequency Detail)

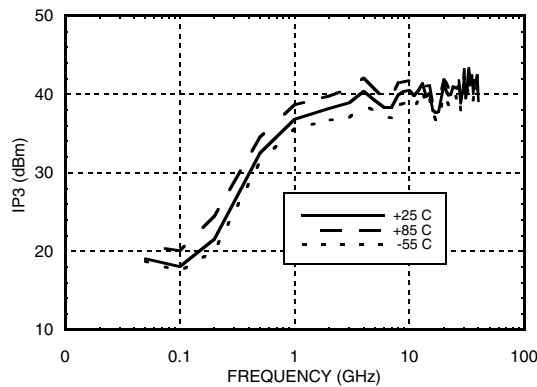

Input Third Order Intercept Point @-3V (Low Frequency Detail)

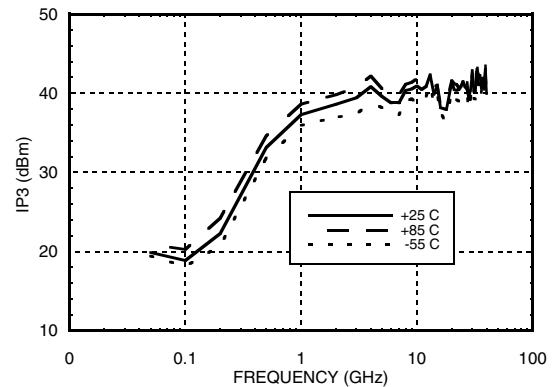

Absolute Maximum Ratings

RF Input Power (0.1 - 0.5 GHz)	+5 dBm
RF Input Power (0.5 - 2 GHz)	+18 dBm
RF Input Power (2 - 50 GHz)	+25 dBm
Control Voltage Range (V1, V2)	+0.5 V to -5.5 V
Hot Switch Power Level (0.1 - 0.5 GHz)	+3 dBm
Hot Switch Power Level (0.5 - 2 GHz)	+16 dBm
Hot Switch Power Level (2 - 50 GHz)	+23 dBm
Channel Temperature	150 °C
Continuous Pdiss (T=85°C) (derate 4.0 mW/°C above 85°C)	0.26 W
Thermal Resistance (channel to die bottom)	250 °C/W
Storage Temperature	-65 to +150 °C
Operating Temperature	-55 to +85 °C

Control Voltages

State	Bias Condition
Low	0 to -0.2V @ 1 uA Typ.
High	-3V to -5V @ 10 uA Typ.



**ELECTROSTATIC SENSITIVE DEVICE
OBSERVE HANDLING PRECAUTIONS**

Truth Table

V1	V2	State
High	Low	RFC to RF1
Low	High	RFC to RF2



GaAs MMIC REFLECTIVE SPDT SWITCH, 0.1 - 50 GHz

Outline Drawing

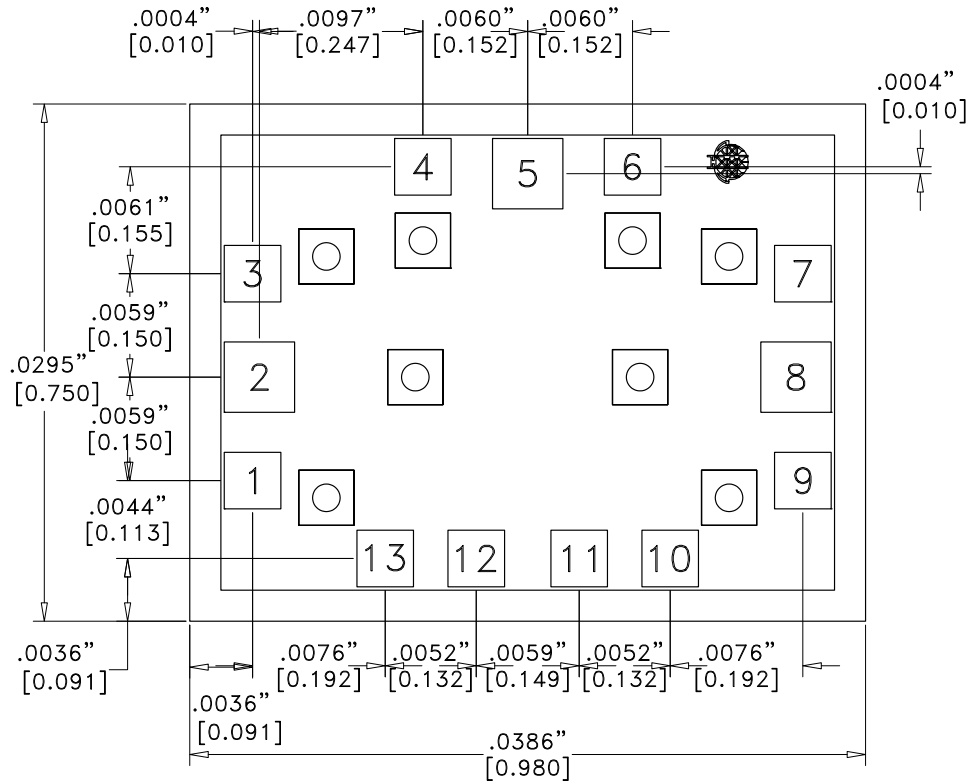

- NOTES:
1. ALL DIMENSIONS ARE IN INCHES [MM]
 2. DIE THICKNESS IS .004"
 3. BACKSIDE METALIZATION: GOLD
 4. BACKSIDE METAL IS GROUND
 5. BOND PAD METALIZATION: GOLD
 6. OVERALL DIE SIZE ±.002"

Die Packaging Information ^[1]

Standard	Alternate
WP-13 (Waffle Pack)	[2]

[1] Refer to the "Packaging Information" section of the Hittite website for die packaging dimensions.

[2] For alternate packaging information contact Hittite Microwave Corporation.



Die Pad Dimensions

Pad Number	Size
2, 5, 8	.004" x .004"
1, 3, 4, 6, 7, 9, 10, 11, 12, 13	.003" x .003"

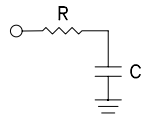

GaAs MMIC REFLECTIVE SPDT SWITCH, 0.1 - 50 GHz

Pad Descriptions

Pad Number	Function	Description	Interface Schematic
2, 5, 8	RF1, RFC, RF2	These pads are DC coupled and matched to 50 Ohm. Blocking capacitors are required if RF line potential is not equal to 0V.	
11	V2	See truth table and control voltage table.	
12	V1		
1, 3, 4, 6, 7, 9	RF Signal Grounds	These pads are connected to die backside ground and can be utilized to realize Ground-Signal-Ground interface for optimum RF performance. HMC986 datasheet performance was measured with Ground-Signal-Ground interface on RF1, RFC, and RF2.	
10, 13	Control Signal Ground Returns	These pads are connected to die backside ground and are optional for use as V1, V2 control signal ground return.	



**GaAs MMIC REFLECTIVE
SPDT SWITCH, 0.1 - 50 GHz**

Assembly Diagram

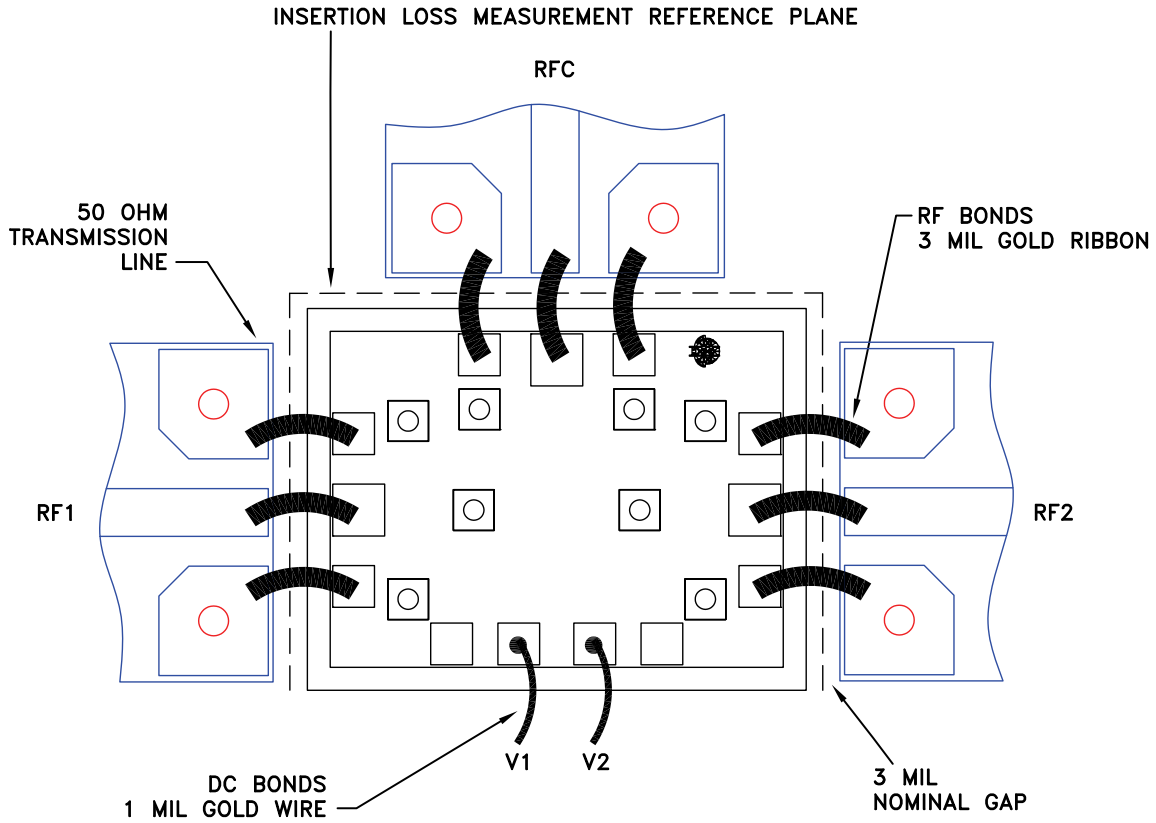



GaAs MMIC REFLECTIVE SPDT SWITCH, 0.1 - 50 GHz

Mounting & Bonding Techniques for Millimeterwave GaAs MMICs

The die should be attached directly to the ground plane eutectically or with conductive epoxy (see HMC general Handling, Mounting, Bonding Note).

50 Ohm Microstrip transmission lines on 0.127mm (5 mil) thick alumina thin film substrates are recommended for bringing RF to and from the chip (Figure 1). If 0.254mm (10 mil) thick alumina thin film substrates must be used, the die should be raised 0.150mm (6 mils) so that the surface of the die is coplanar with the surface of the substrate. One way to accomplish this is to attach the 0.102mm (4 mil) thick die to a 0.150mm (6 mil) thick molybdenum heat spreader (moly-tab) which is then attached to the ground plane (Figure 2).

Microstrip substrates should be brought as close to the die as possible in order to minimize bond wire length. Typical die-to-substrate spacing is 0.076mm (3 mils).

Handling Precautions

Follow these precautions to avoid permanent damage.

Storage: All bare die are placed in either Waffle or Gel based ESD protective containers, and then sealed in an ESD protective bag for shipment. Once the sealed ESD protective bag has been opened, all die should be stored in a dry nitrogen environment.

Cleanliness: Handle the chips in a clean environment. DO NOT attempt to clean the chip using liquid cleaning systems.

Static Sensitivity: Follow ESD precautions to protect against ESD strikes.

Transients: Suppress instrument and bias supply transients while bias is applied. Use shielded signal and bias cables to minimize inductive pick-up.

General Handling: Handle the chip along the edges with a vacuum collet or with a sharp pair of bent tweezers. The surface of the chip has fragile air bridges and should not be touched with vacuum collet, tweezers, or fingers.

Mounting

The chip is back-metallized and can be die mounted with AuSn eutectic preforms or with electrically conductive epoxy. The mounting surface should be clean and flat.

Epoxy Die Attach: Apply a minimum amount of epoxy to the mounting surface so that a thin epoxy fillet is observed around the perimeter of the chip once it is placed into position. Cure epoxy per the manufacturer's schedule.

Wire Bonding

Ball or wedge bond with 0.025 mm (1 mil) diameter pure gold wire (DC bias, IF1 and IF2) or Ribbon Bond (RF and LO ports) 0.076 mm x 0.013 mm (3 mil x 0.5 mil) size is recommended. Thermosonic wirebonding with a nominal stage temperature of 150 °C and a ball bonding force of 40 to 50 grams or wedge bonding force of 18 to 22 grams is recommended. Use the minimum level of ultrasonic energy to achieve reliable wirebonds. Wirebonds should be started on the chip and terminated on the package or substrate. All bonds should be as short as possible <0.31 mm (12 mils).

