

FP1 109B

High frequency, high current power inductors



Applications

- Compatible with Infineon® DrBlade™ digital voltage regulator controller
- Multi-phase and Vcore regulators
- Voltage Regulator Modules (VRMs)
 - Server and desktop
 - Central processing unit (CPU)
 - Graphics processing unit (GPU)
 - Application specific integrated circuit (ASIC)
 - High power density
- Data centers, networking and storage systems
- Point-of-Load modules
- DCR Sensing circuits

Product description

- High current carrying capacity
- Low core loss
- Controlled DCR for sensing circuits
- Inductance Range from 150nH to 300nH
- Current range from 38 to 80 amps
- 11.0 x 8.2mm footprint surface mount package in 9.0mm height
- Ferrite core material
- Halogen free, lead free, RoHS compliant

Environmental data

- Storage temperature range (Component): -40°C to +125°C
- Operating temperature range: -40°C to +125°C (ambient + self-temperature rise)
- Solder reflow temperature: J-STD-020D compliant



Infineon® and DrBlade™ are trademarks of Infineon Technologies AG

Product specifications

Part Number ⁷	OCL ¹ (nH)±10%	FLL ² (nH) minimum	I _{rms} ³ (amps)	I _{sat} 1 ⁴ (amps)	I _{sat} 2 ⁵ (amps)	DCR (mΩ) @ 20°C ±5%	K-factor ⁸
FP1109B1-R150-R	150	108	55	80	64	0.19	339
FP1109B1-R180-R	180	130	55	62	49	0.19	339
FP1109B1-R220-R	220	158	55	50	40	0.19	339
FP1109B1-R300-R	300	216	55	38	30	0.19	339

- Open Circuit Inductance (OCL) Test Parameters: 100kHz, 0.1Vrms, 0.0Adc, +25°C
- Full Load Inductance (FLL) Test Parameters: 100kHz, 0.1Vrms, I_{sat}1, +25°C
- I_{rms}: DC current for an approximate temperature rise of 40°C without core loss. Derating is necessary for AC currents. PCB layout, trace thickness and width, air-flow, and proximity of other heat generating components will affect the temperature rise. It is recommended that the temperature of the part not exceed 125°C under worst case operating conditions verified in the end application.
- I_{sat}1: Peak current for approximately 20% rolloff @ +25°C
- I_{sat}2: Peak current for approximately 20% rolloff @ +125°C
- K-factor: Used to determine B_{pp} for core loss (see graph).
 $B_{pp} = K * L * \Delta I * 10^{-3}$; B_{pp}-(Gauss), K: (K-factor from table),
 L: (Inductance in nH), ΔI (Peak-to-peak ripple current in Amps).
- Part Number Definition: FP1109Bx-Rxxx-R
 FP1109B= Product code and size
 x= version indicator
 Rxxx= Inductance value in μH, R= decimal point
 -R suffix = RoHS compliant

Dimensions (mm)

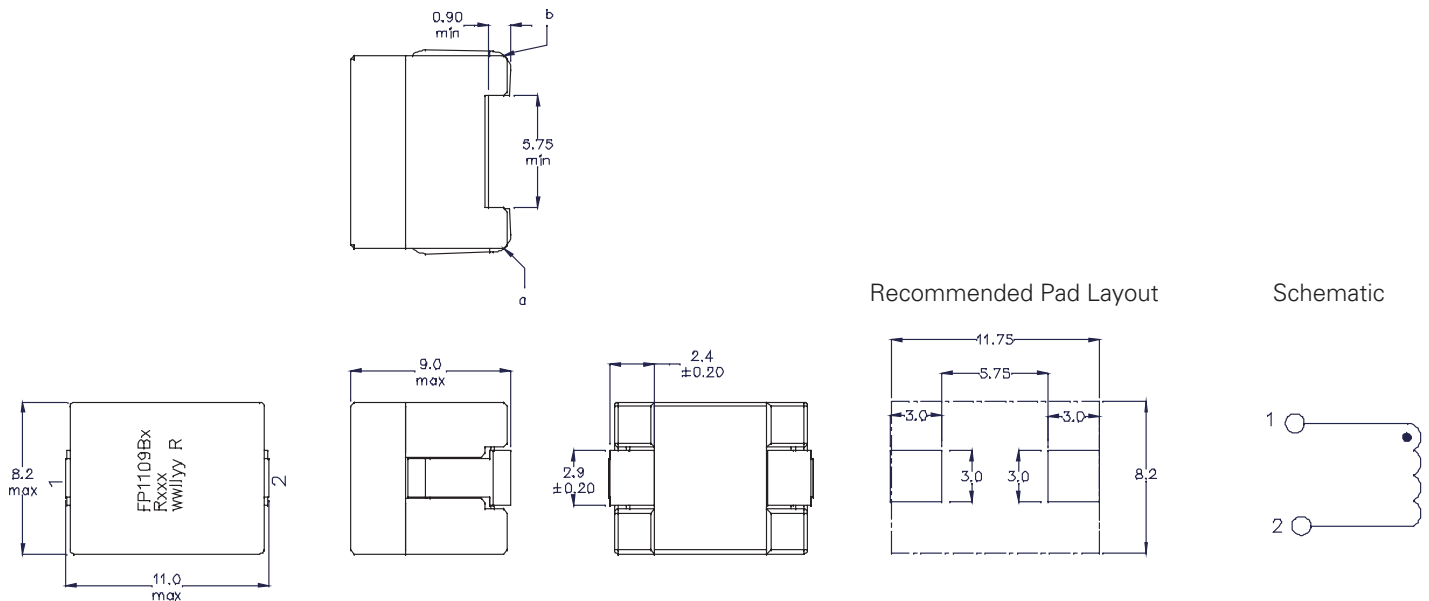

Part marking: FP1109Bx (Product code and size, x = version indicator),
 Rxxx = Inductance value in μh, R = decimal point
 wwlllyy = date code, R = revision level
 All soldering surface to be coplanar within 0.10mm
 DCR measured between point "a" and point "b"

Packaging information (mm)

Supplied in tape and reel packaging 300 parts per 1 3 " diameter reel

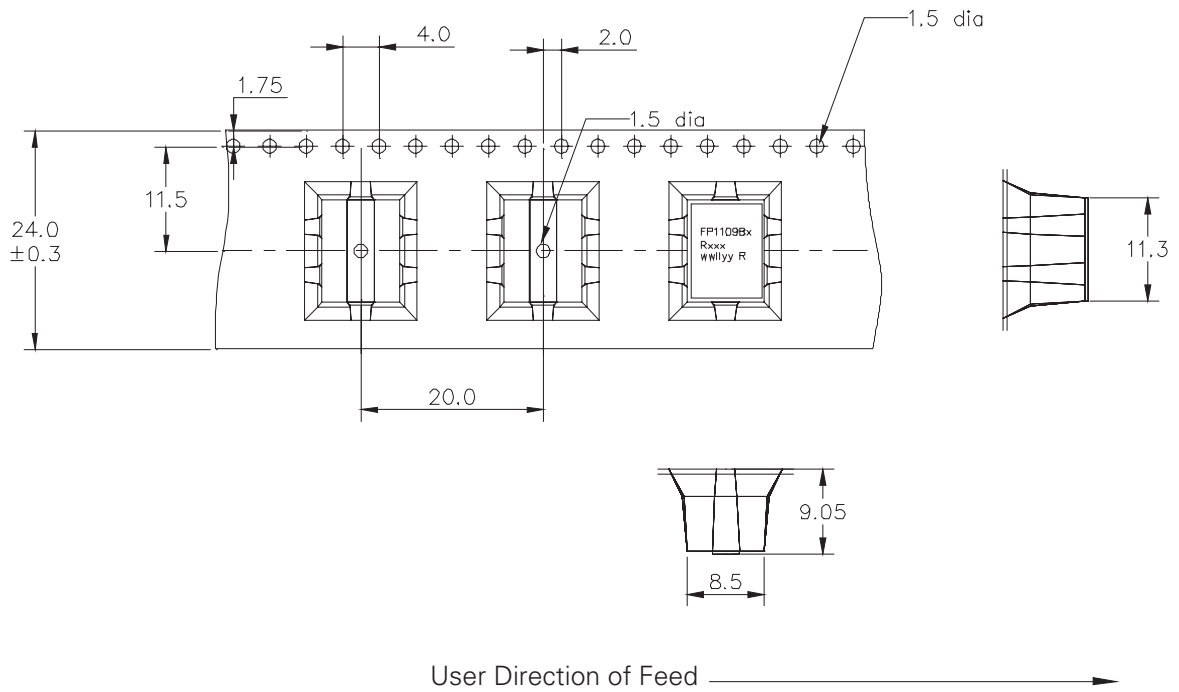

Temperature rise vs. total loss

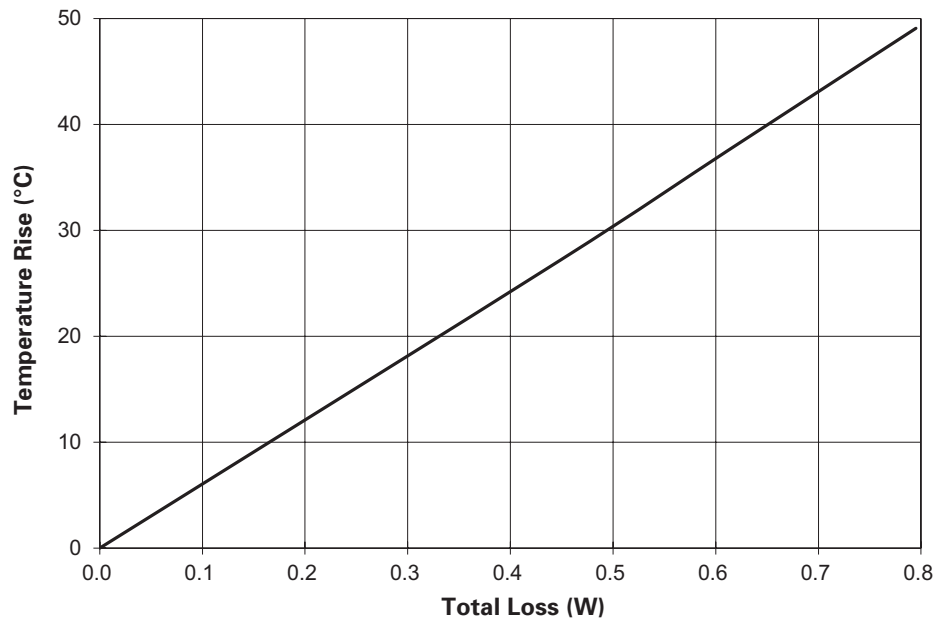

Core loss vs. B_{p-p}

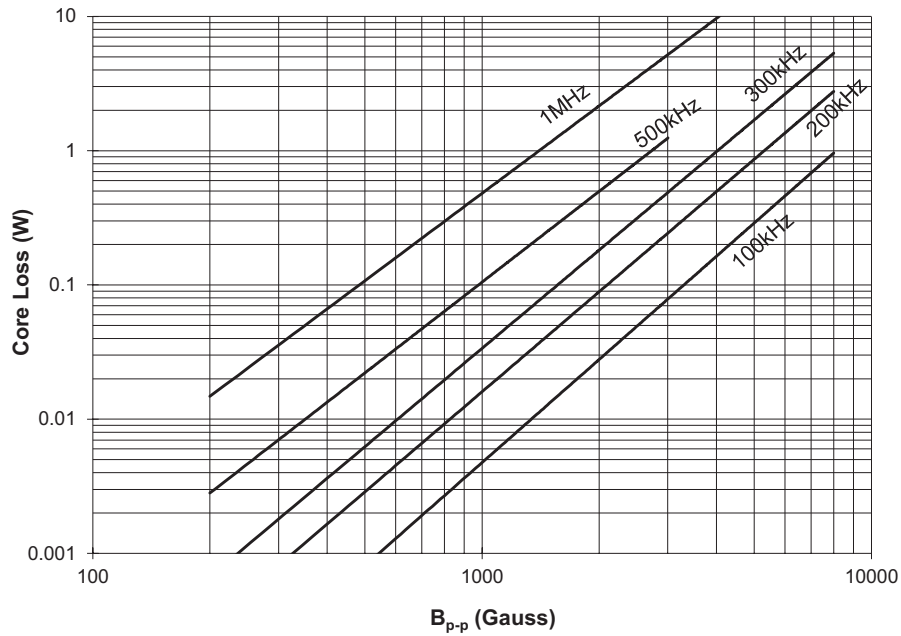

Inductance characteristics

FP1109B1-R150-R

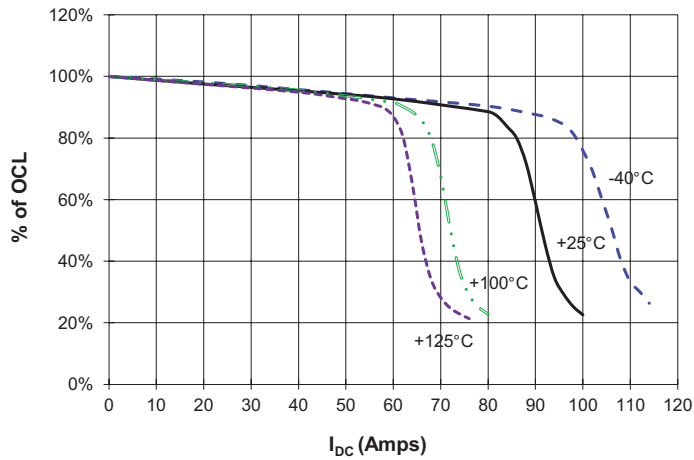

FP1109B1-R180-R

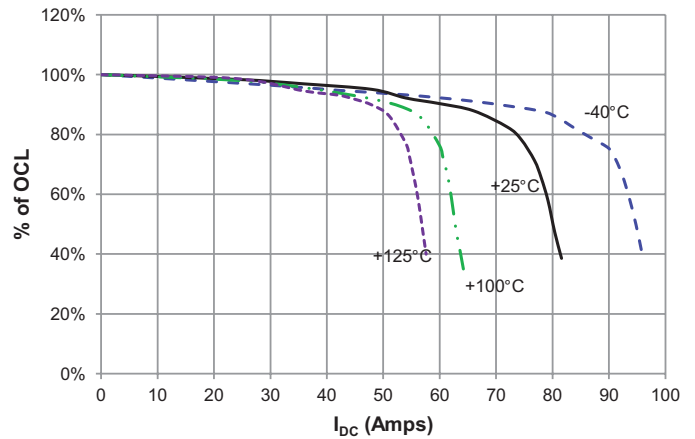

FP1109B1-R220-R

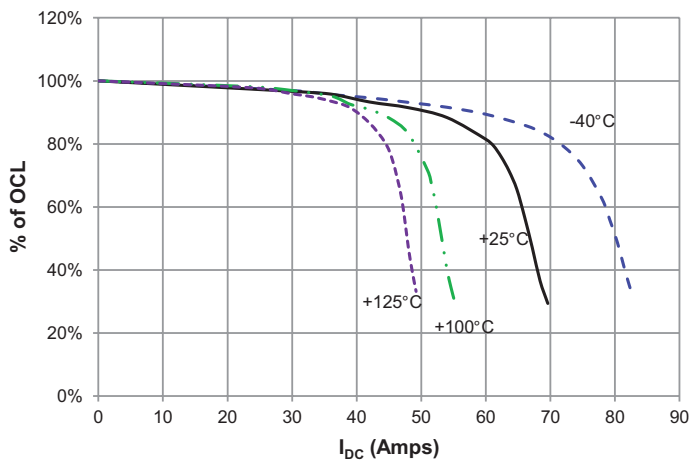

FP1109B1-R300-R

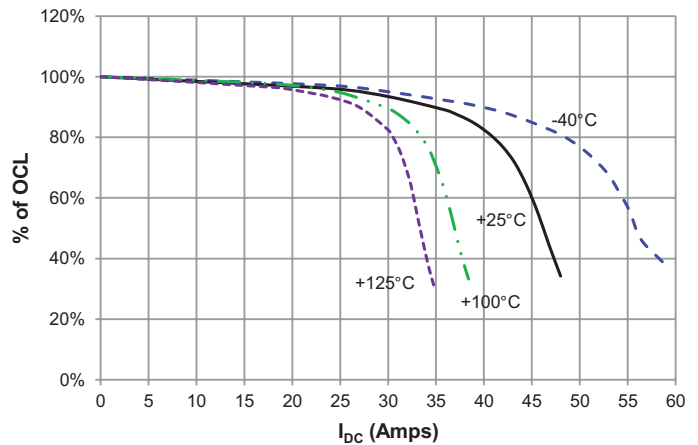

Solder reflow profile

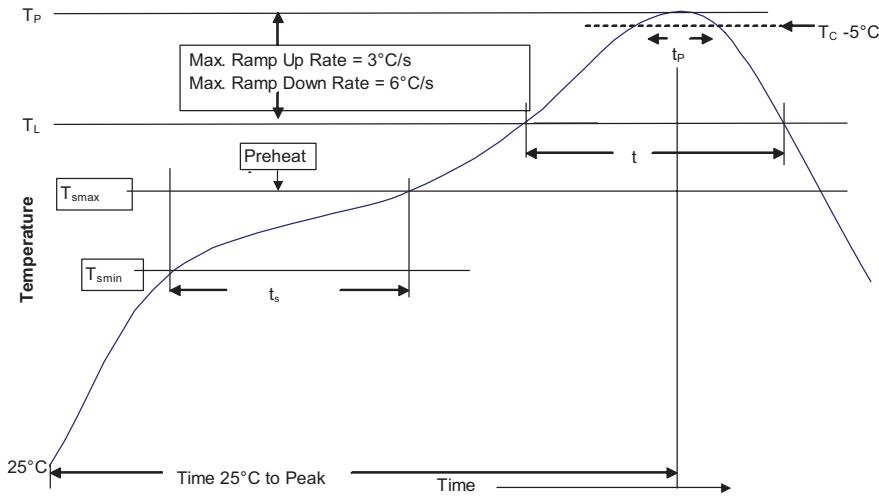

Table 1 - Standard SnPb Solder (T_C)

Package Thickness	Volume mm ³ <350	Volume mm ³ ≥350
<2.5mm)	235°C	220°C
≥2.5mm	220°C	220°C

Table 2 - Lead (Pb) Free Solder (T_C)

Package Thickness	Volume mm ³ <350	Volume mm ³ 350 - 2000	Volume mm ³ >2000
<1.6mm	260°C	260°C	260°C
1.6 – 2.5mm	260°C	250°C	245°C
>2.5mm	250°C	245°C	245°C

Reference JDEC J-STD-020D

Profile Feature	Standard SnPb Solder	Lead (Pb) Free Solder
Preheat and Soak		
• Temperature min. (T _{smin})	100°C	150°C
• Temperature max. (T _{smax})	150°C	200°C
• Time (T _{smin} to T _{smax}) (t _s)	60-120 Seconds	60-120 Seconds
Average ramp up rate T _{smax} to T _p	3°C/ Second Max.	3°C/ Second Max.
Liquidous temperature (T _L)	183°C	217°C
Time at liquidous (t _L)	60-150 Seconds	60-150 Seconds
Peak package body temperature (T _p)*	Table 1	Table 2
Time (t _p)** within 5 °C of the specified classification temperature (T _C)	20 Seconds**	30 Seconds**
Average ramp-down rate (T _p to T _{smax})	6°C/ Second Max.	6°C/ Second Max.
Time 25°C to Peak Temperature	6 Minutes Max.	8 Minutes Max.

* Tolerance for peak profile temperature (T_p) is defined as a supplier minimum and a user maximum.
 ** Tolerance for time at peak profile temperature (t_p) is defined as a supplier minimum and a user maximum.

Life Support Policy: Eaton does not authorize the use of any of its products for use in life support devices or systems without the express written approval of an officer of the Company. Life support systems are devices which support or sustain life, and whose failure to perform, when properly used in accordance with instructions for use provided in the labeling, can be reasonably expected to result in significant injury to the user.

Eaton
Electronics Division
 1000 Eaton Boulevard
 Cleveland, OH 44122
 United States
 www.eaton.com/elx

© 2015 Eaton
 All Rights Reserved
 Printed in USA
 Publication No. 10465 BU-MC15044
 October 2015

Eaton is a registered trademark.
 All other trademarks are property of their respective owners.

