

# APT70SM70B

PRELIMINARY

700V, 58A, 75mΩ

## Silicon Carbide N-Channel Power MOSFET

### DESCRIPTION

Silicon carbide power MOSFET solutions with Microsemi-proprietary passivation technology provides maximum SiC benefits over silicon MOSFET solutions that include higher energy conversion efficiency with 10x higher breakdown field resistance resulting in lower RDS(on); lower switching losses due to temperature-independent switching behavior for stable high temperature performance and 2x higher electron saturation; improved system cooling with 3x higher band gap energy to operate at higher junction temperatures; and higher current capabilities with 3x higher thermal conductivity for higher power density. Faster switching frequencies combined with the above characteristics provide higher efficiency, lower power losses for power topologies that lower total cost of ownership with higher reliability and efficiency, lower passive and system costs, and smaller heat sinks.

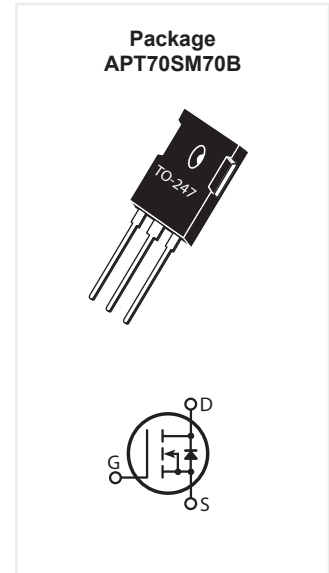

### FEATURES / TYPICAL APPLICATIONS

- Ultra Low sensitivity of  $R_{DS(on)}$  to temperature
- Fast switching with low EMI/RFI
- Low Switching Energy
- Low  $R_{DS(on)}$  Temperature Coefficient For Improved Efficiency
- Ultra Low Gate Resistance
- RoHS compliant
- PFC and other boost converter
- Buck Converter
- Two Switch forward (asymmetrical)
- Single Switch forward
- Flyback
- Inverters

### MAXIMUM RATINGS

Symbol	Parameter	Ratings	Unit
$V_{DSS}$	Drain Source Voltage	700	V
$I_D$	Continuous Drain Current @ $T_c = 25^\circ\text{C}$	58	A
	Continuous Drain Current @ $T_c = 100^\circ\text{C}$	41	
$I_{DM}$	Pulsed Drain Current <sup>①</sup>	137	
$V_{GS}$	Gate-Source Voltage	-10 to +25	V
$P_D$	Total Power Dissipation @ $T_c = 25^\circ\text{C}$	300	W
	Linear Derating Factor	2.0	W/°C

### THERMAL AND MECHANICAL CHARACTERISTICS

Symbol	Characteristic	Min	Typ	Max	Unit
$R_{\theta JC}$	Junction to Case Thermal Resistance		0.35	0.5	°C/W
$T_j$	Operating Junction Temperature	-55		175	°C
$T_{stg}$	Storage Junction Temperature Range	-55		150	
$T_L$	Soldering Temperature for 10 Seconds (1.6mm from case)			260	
Torque	Mounting Torque (TO-247 Package), 6-32 or M3 screw			10	in·lbf
				1.1	N·m

# APT70SM70B

## STATIC CHARACTERISTICS

Symbol	Parameter	Test Conditions	Min	Typ	Max	Unit
$V_{(BR)DSS}$	Drain-Source Breakdown Voltage	$V_{GS} = 0V, I_D = 1mA$	700			V
$R_{DS(on)}$	Drain-Source On Resistance <sup>②</sup>	$V_{GS} = 20V, I_D = 30A$		75	90	mΩ
$V_{GS(th)}$	Gate-Source Threshold Voltage	$V_{GS} = V_{DS}, I_D = 1mA$	1.7	2.5		V
$\Delta V_{GS(th)}/\Delta T_J$	Threshold Voltage Temperature Coefficient			-4.9		mV/°C
$I_{DSS}$	Zero Gate Voltage Drain Current	$V_{DS} = 700V$ $V_{GS} = 0V$	$T_J = 25^\circ C$		100	μA
			$T_J = 150^\circ C$		250	
$I_{GSS}$	Gate-Source Leakage Current	$V_{GS} = +20V / -10V$			±100	nA
ESR	Equivalent Series Resistance	$f = 1MHz, 25mV, \text{Drain Short}$		0.97		Ω

$T_J = 25^\circ C$  unless otherwise specified

## DYNAMIC CHARACTERISTICS

Symbol	Parameter	Test Conditions	Min	Typ	Max	Unit
$C_{iss}$	Input Capacitance	$V_{GS} = 0V, V_{DD} = 700V$ $f = 1MHz$		1935		pF
$C_{rss}$	Reverse Transfer Capacitance			45		
$C_{oss}$	Output Capacitance			240		
$Q_g$	Total Gate Charge	$V_{GS} = 0/20V$ $V_{DD} = 466V$ $I_D = 30A$		120		nC
$Q_{gs}$	Gate-Source Charge			20		
$Q_{gd}$	Gate-Drain Charge			34		
$t_{d(on)}$	Turn-On Delay Time	$V_{DD} = 466V$ $V_{GS} = 0/20V$ $I_D = 30A$ $R_G = 3.0 \Omega$ <sup>③</sup> $L = 115 \mu H$ $T_c = 25^\circ C$ Freewheeling Diode = APT10SCE65B		11		ns
$t_r$	Current Rise Time			9		
$t_{d(off)}$	Turn-Off Delay Time			34		
$t_f$	Current Fall Time			20		
$E_{on2}$	Turn-On Switching Energy <sup>④</sup>			291		
$E_{off}$	Turn-Off Switching Energy		122			
$t_{d(on)}$	Turn-On Delay Time	$V_{DD} = 466V$ $V_{GS} = 0/20V$ $I_D = 30A$ $R_G = 3.0 \Omega$ <sup>③</sup> $L = 115 \mu H$ $T_c = 150^\circ C$ Freewheeling Diode = APT10SCE65B		10		ns
$t_r$	Current Rise Time			9		
$t_{d(off)}$	Turn-Off Delay Time			37		
$t_f$	Current Fall Time			24		
$E_{on2}$	Turn-On Switching Energy <sup>④</sup>			257		
$E_{off}$	Turn-Off Switching Energy		135			

### Source-Drain Diode Characteristics

Symbol	Parameter	Test Conditions	Min	Typ	Max	Unit
$V_{SD}$	Diode Forward Voltage	$I_{SD} = 30A, V_{GS} = 0V$		4.45		V
$t_{rr}$	Reverse Recovery Time	$I_{SD} = 30A, V_{DD} = 466V$ $di/dt = -1000A/\mu s$		66		ns
$Q_{rr}$	Reverse Recovery Charge			320		nC
$I_{rrm}$	Reverse Recovery Current			10		A

$T_J = 25^\circ C$  unless otherwise specified

- ① Repetitive Rating: Pulse width and case temperature limited by maximum junction temperature  
 ② Pulse test: Pulse Width < 380μs, duty cycle < 2%.  
 ③  $R_G$  is total external gate resistance including internal gate driver impedance.  
 ④  $E_{on2}$  includes energy of APT10SCE65B free wheeling diode.

# APT70SM70B

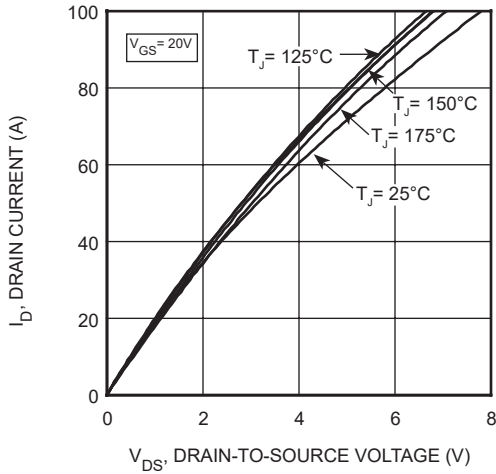

Figure 1, Output Characteristics

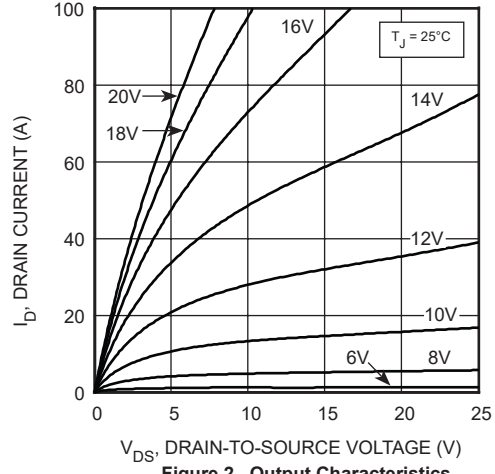

Figure 2, Output Characteristics

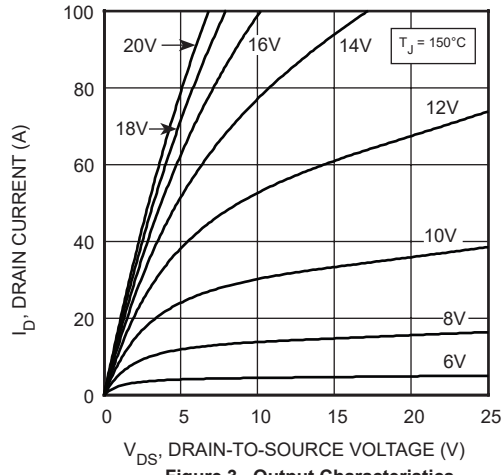

Figure 3, Output Characteristics

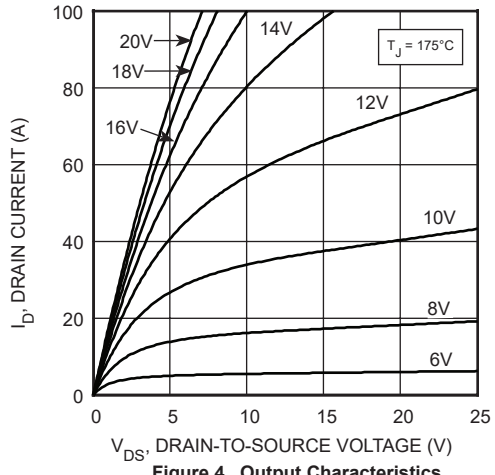

Figure 4, Output Characteristics

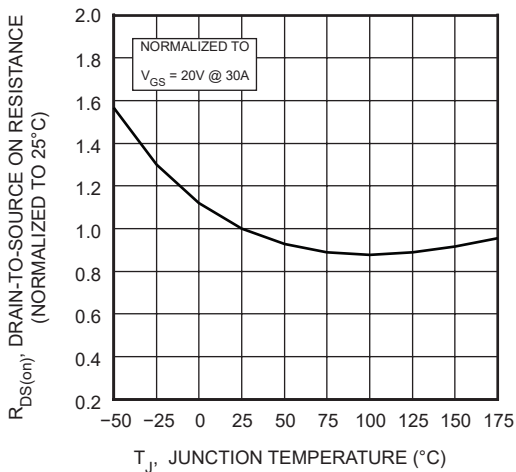

Figure 5,  $R_{DS(on)}$  vs Junction Temperature

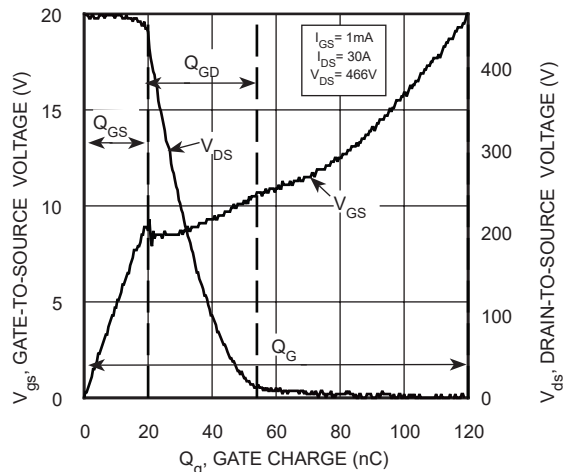

Figure 6, Gate Charge Characteristics

# APT70SM70B

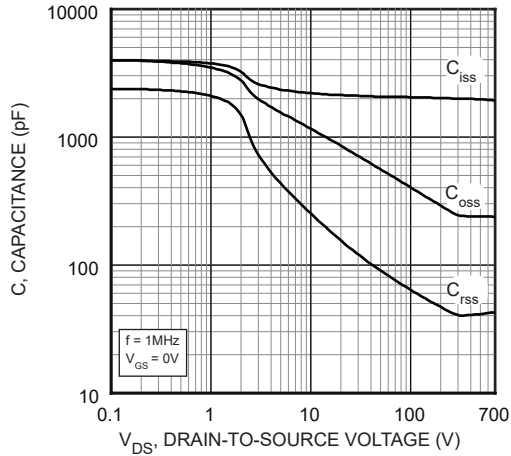

Figure 7, Capacitance vs Drain-to-Source Voltage

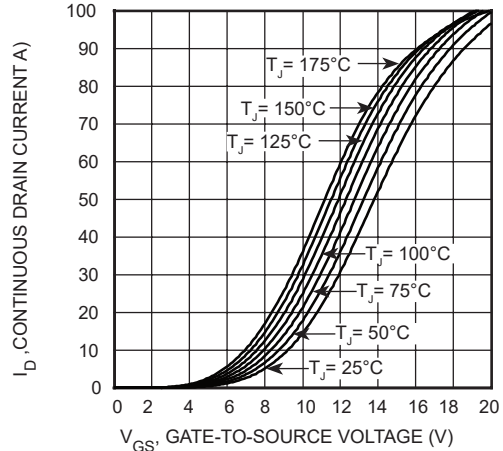

Figure 8, Output Characteristics  $I_D$  vs  $V_{GS}$  Temperature

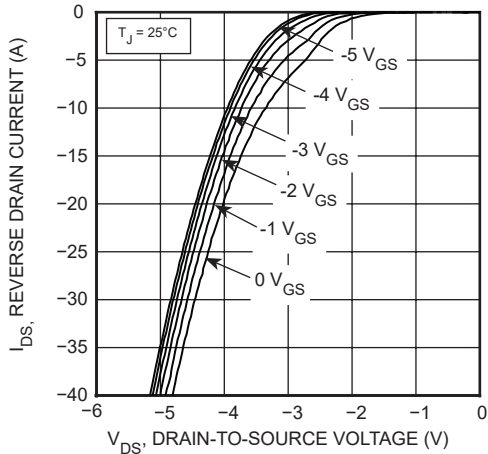

Figure 9, Reverse Drain Current vs Drain-to-Source Voltage Third Quadrant Conduction

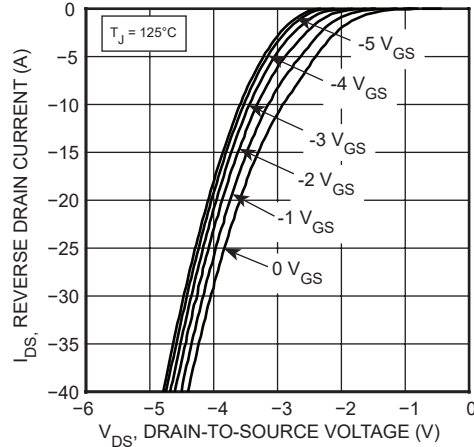

Figure 10, Reverse Drain Current vs Drain-to-Source Voltage Third Quadrant Conduction

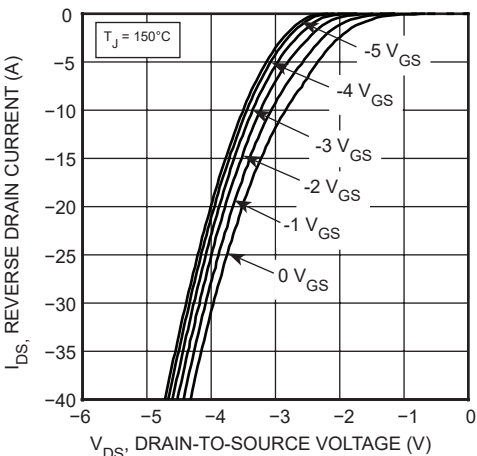

Figure 11, Reverse Drain Current vs Drain-to-Source Voltage Third Quadrant Conduction

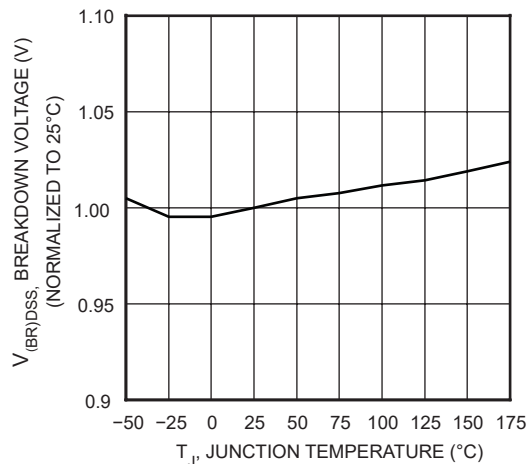

Figure 12, Breakdown Voltage vs Temperature

# APT70SM70B

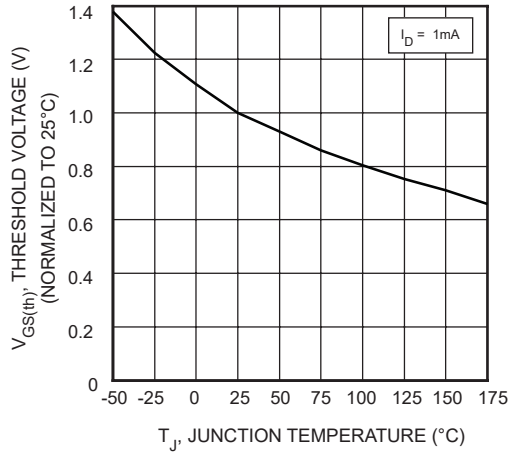

Figure 13, Threshold Voltage vs Temperature

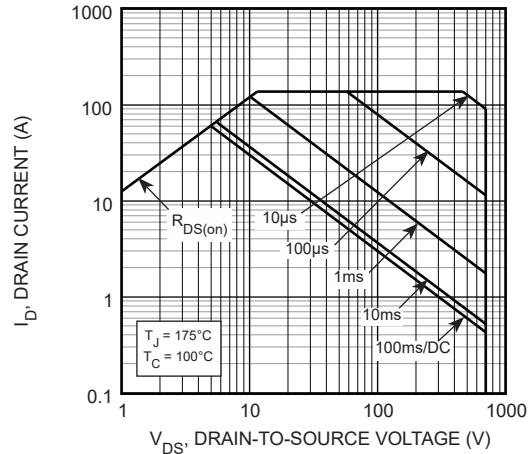

Figure 14, Forward Safe Operating Area

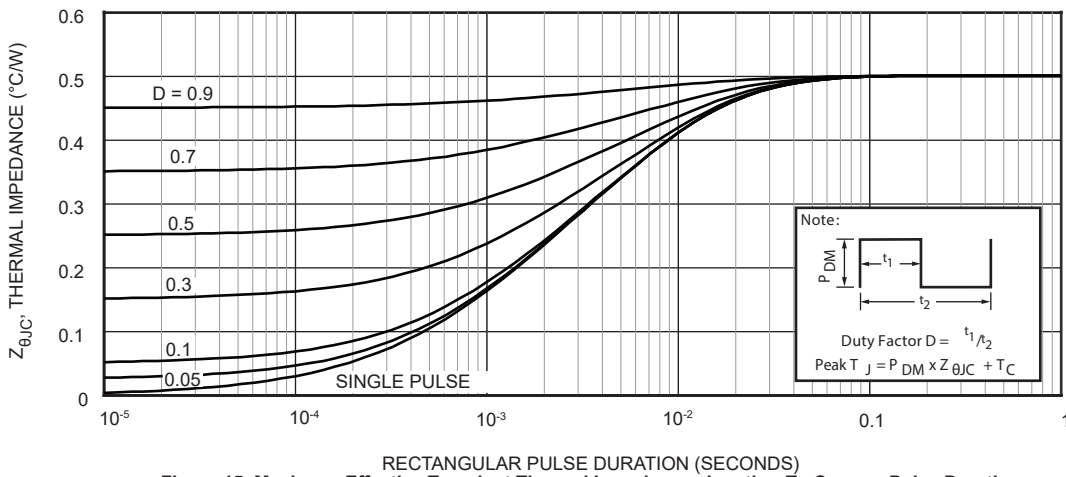
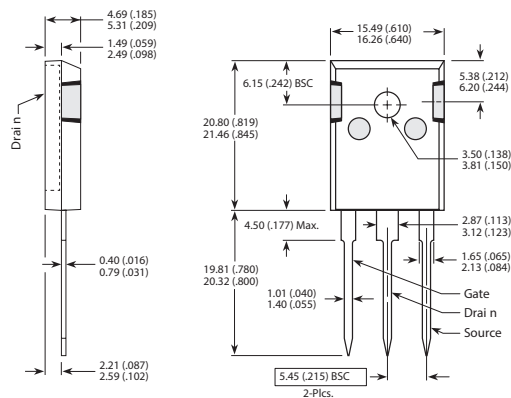

Figure 15, Maximum Effective Transient Thermal Impedance, Junction-To-Case vs Pulse Duration

## TO-247 (B) Package Outline



Dimensions in Millimeters (Inches)

Microsemi makes no warranty, representation, or guarantee regarding the information contained herein or the suitability of its products and services for any particular purpose, nor does Microsemi assume any liability whatsoever arising out of the application or use of any product or circuit. The products sold hereunder and any other products sold by Microsemi have been subject to limited testing and should not be used in conjunction with mission-critical equipment or applications. Any performance specifications are believed to be reliable but are not verified, and Buyer must conduct and complete all performance and other testing of the products, alone and together with, or installed in, any end-products. Buyer shall not rely on any data and performance specifications or parameters provided by Microsemi. It is the Buyer's responsibility to independently determine suitability of any products and to test and verify the same. The information provided by Microsemi hereunder is provided "as is, where is" and with all faults, and the entire risk associated with such information is entirely with the Buyer. Microsemi does not grant, explicitly or implicitly, to any party any patent rights, licenses, or any other IP rights, whether with regard to such information itself or anything described by such information. Information provided in this document is proprietary to Microsemi, and Microsemi reserves the right to make any changes to the information in this document or to any products and services at any time without notice.



Microsemi Corporate Headquarters  
One Enterprise, Aliso Viejo, CA 92656 USA  
Within the USA: +1 (800) 713-4113  
Outside the USA: +1 (949) 380-6100  
Sales: +1 (949) 380-6136  
Fax: +1 (949) 215-4996  
email: [sales.support@microsemi.com](mailto:sales.support@microsemi.com)  
[www.microsemi.com](http://www.microsemi.com)

Microsemi Corporation (Nasdaq: MSCC) offers a comprehensive portfolio of semiconductor and system solutions for communications, defense & security, aerospace and industrial markets. Products include high-performance and radiation-hardened analog mixed-signal integrated circuits, FPGAs, SoCs and ASICs; power management products; timing and synchronization devices and precise time solutions, setting the world's standard for time; voice processing devices; RF solutions; discrete components; security technologies and scalable anti-tamper products; Ethernet Solutions; Power-over-Ethernet ICs and midspans; as well as custom design capabilities and services. Microsemi is headquartered in Aliso Viejo, Calif., and has approximately 4,800 employees globally. Learn more at [www.microsemi.com](http://www.microsemi.com).

©2016 Microsemi Corporation. All rights reserved. Microsemi and the Microsemi logo are registered trademarks of Microsemi Corporation. All other trademarks and service marks are the property of their respective owners.