

## Single and Dual Ultra-Low Noise, Ultra-Low Distortion, Rail-to-Rail, Low Power Op Amp

The ISL55191 and ISL55291 are single and dual high speed operational amplifiers featuring low noise, low distortion, and rail-to-rail output drive capability. They are designed to operate with single and dual supplies from +5VDC ( $\pm 2.5$ VDC) down to +3VDC ( $\pm 1.5$ VDC). These amplifiers draw 6.1mA of quiescent supply current per amplifier. For power conservation, this family offers a low-power shutdown mode that reduces supply current to 21 $\mu$ A and places the amplifiers' output into a high impedance state. The ISL55191 ENABLE logic places the device in the shutdown mode with EN = 0 and the ISL55291 is placed in the shutdown mode with  $\overline{\text{EN}}$  = 1.

These amplifiers have excellent input and output overload recovery times and outputs that swing rail-to-rail. Their input common mode voltage range includes ground. The ISL55191 and ISL55291 are stable at gains as low as 10 with an input referred noise voltage of 1.3nV/ $\sqrt{\text{Hz}}$  and harmonic distortion products -94dBc (2nd) and -104dBc (3rd) below a 1MHz 2V<sub>p-p</sub> signal.

The ISL55191 is available in space-saving 8 Ld DFN and 8 Ld SOIC packages. The ISL55291 is available in a 10 Ld MSOP package.

### Ordering Information

PART NUMBER (Note)	PART MARKING	TAPE AND REEL	PACKAGE (Pb-Free)	PKG. DWG. #
ISL55191IBZ	55191 IBZ	-	8 Ld SOIC	MDP0027
ISL55191IBZ-T13	55191 IBZ	13" (2,500 pcs)	8 Ld SOIC Tape and Reel	MDP0027
ISL55191IRZ	191Z	-	8 Ld DFN	L8.3x3D
ISL55191IRZ-T13	191Z	13" (2,500 pcs)	8 Ld DFN Tape and Reel	L8.3x3D
ISL55291IUZ	5291Z	-	10 Ld MSOP	MDP0043
ISL55291IUZ-T13	5291Z	13" (2,500 pcs)	10 Ld MSOP Tape and Reel	MDP0043
Coming Soon ISL55191EVAL1Z	Evaluation Board			
Coming Soon ISL55291EVAL1Z	Evaluation Board			

NOTE: Intersil Pb-free plus anneal products employ special Pb-free material sets; molding compounds/die attach materials and 100% matte tin plate termination finish, which are RoHS compliant and compatible with both SnPb and Pb-free soldering operations. Intersil Pb-free products are MSL classified at Pb-free peak reflow temperatures that meet or exceed the Pb-free requirements of IPC/JEDEC J STD-020.

### Features

- 1.3nV/ $\sqrt{\text{Hz}}$  input voltage noise,  $f_O = 1\text{kHz}$
- Harmonic Distortion -94dBc, -104dBc,  $f_O = 1\text{MHz}$
- Stable at gains as low as 10
- 800MHz gain bandwidth product ( $A_V = 10$ )
- 260V/ $\mu\text{s}$  slew rate
- 6.1mA supply current (21 $\mu$ A in disable mode)
- 800 $\mu$ V maximum offset voltage
- 12 $\mu$ A input bias current
- 3V to 5.5V single supply voltage range
- Rail-to-rail output
- Pb-free plus anneal available (RoHS compliant)

### Applications

- High speed pulse applications
- Low noise signal processing
- ADC buffers
- DAC output amplifiers
- Radio systems
- Portable equipment

TABLE 1. ENABLE LOGIC

	ENABLE	DISABLE
ISL55191	EN = 1	EN = 0
ISL55291	$\overline{\text{EN}}$ = 0	$\overline{\text{EN}}$ = 1

Pinouts

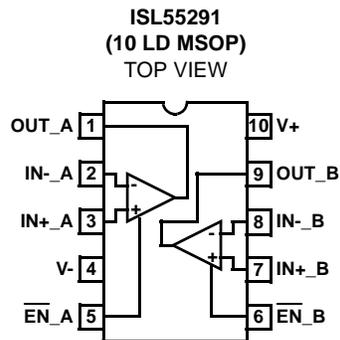
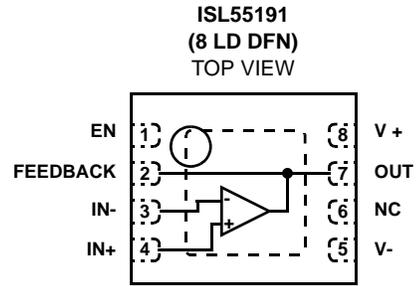
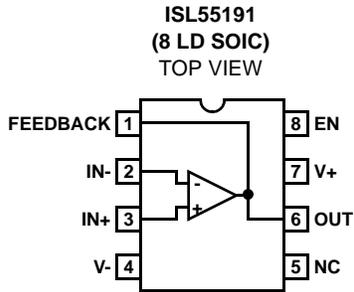

# ISL55191, ISL55291

## Absolute Maximum Ratings ( $T_A = +25^\circ\text{C}$ )

Supply Voltage	5.5V
Supply Turn On Voltage Slew Rate	1V/ $\mu\text{s}$
Differential Input Current	5mA
Differential Input Voltage	0.5V
Input Voltage	V- - 0.5V to V+ + 0.5V
ESD tolerance, Human Body Model	3kV
ESD tolerance, Machine Model	300V
ESD Rating	
Human Body Model (Per MIL-STD-883 Method 3015.7)	3kV
Machine Model (Per EIAJ ED-4701 Method C-111)	300V

## Thermal Information

Thermal Resistance	$\theta_{JA}$ ( $^\circ\text{C}/\text{W}$ )
8 Ld DFN Package	TBD
8 Ld SO Package	110
8 Ld MSOP Package	115
Ambient Operating Temperature Range	-40 $^\circ\text{C}$ to +85 $^\circ\text{C}$
Storage Temperature Range	-65 $^\circ\text{C}$ to +150 $^\circ\text{C}$
Operating Junction Temperature	+125 $^\circ\text{C}$
Pb-free reflow profile	see link below
	<a href="http://www.intersil.com/pbfree/Pb-FreeReflow.asp">http://www.intersil.com/pbfree/Pb-FreeReflow.asp</a>

**CAUTION:** Stresses above those listed in "Absolute Maximum Ratings" may cause permanent damage to the device. This is a stress only rating and operation of the device at these or any other conditions above those indicated in the operational sections of this specification is not implied.

**IMPORTANT NOTE:** All parameters having Min/Max specifications are guaranteed. Typical values are for information purposes only. Unless otherwise noted, all tests are at the specified temperature and are pulsed tests, therefore:  $T_J = T_C = T_A$

**Electrical Specifications**  $V_+ = 5\text{V}$ ,  $V_- = \text{GND}$ ,  $R_L = 1\text{k}\Omega$ ,  $R_G = 30\Omega$ ,  $R_F = 270\Omega$ , unless otherwise specified. Parameters are per amplifier. All values are at  $V_+ = 5\text{V}$ ,  $T_A = +25^\circ\text{C}$ .

PARAMETER	DESCRIPTION	CONDITIONS	MIN	TYP	MAX	UNIT
<b>DC SPECIFICATIONS</b>						
$V_{OS}$	Input Offset Voltage			170	800	$\mu\text{V}$
$\frac{\Delta V_{OS}}{\Delta T}$	Input Offset Drift vs Temperature	-40 $^\circ\text{C}$ to +85 $^\circ\text{C}$		2.2		$\mu\text{V}/^\circ\text{C}$
$I_{OS}$	Input Offset Current			0.3	0.7	$\mu\text{A}$
$I_B$	Input Bias Current			-12	-19	$\mu\text{A}$
$V_{CM}$	Common-Mode Voltage Range		0		3.8	V
CMRR	Common-Mode Rejection Ratio	$V_{CM} = 0\text{V}$ to 3.8V	85	100		dB
PSRR	Power Supply Rejection Ratio	$V_+ = 3\text{V}$ to 5V	70	77		dB
$A_{VOL}$	Large Signal Voltage Gain	$V_O = 0.5\text{V}$ to 4V, $R_L = 1\text{k}\Omega$	85	97		dB
$V_{OUT}$	Maximum Output Voltage Swing	Output low, $R_L = 1\text{k}\Omega$ connected to $V_+/2$		23	40	mV
		Output high, $R_L = 1\text{k}\Omega$ connected to $V_+/2$	4.96	4.98		V
$I_{S,ON}$	Supply Current, Enabled	ISL55191		6.1	9	mA
		ISL55291		12	18	mA
$I_{S,OFF}$	Supply Current, Disabled			21	40	$\mu\text{A}$
$I_{O+}$	Short-Circuit Output Current	$R_L = 10\Omega$ connected to $V_+/2$	110	132		mA
$I_{O-}$	Short-Circuit Output Current	$R_L = 10\Omega$ connected to $V_+/2$	110	132		mA
$V_{SUPPLY}$	Supply Operating Range	$V_+$ to $V_-$	3		5	V
$V_{INH}$	ENABLE High Level		2			V
$V_{INL}$	ENABLE Low Level				0.8	V
$I_{ENH}$	ENABLE Input High Current $V_{EN} = V_+$	ISL55191 (EN)		20	80	nA
		ISL55291 ( $\overline{\text{EN}}$ )		0.8	1.5	$\mu\text{A}$
$I_{ENL}$	ENABLE Input Low Current $V_{EN} = V_-$	ISL55191 (EN)		5	6.2	$\mu\text{A}$
		ISL55291 ( $\overline{\text{EN}}$ )		20	80	nA

## ISL55191, ISL55291

**Electrical Specifications**  $V_+ = 5V$ ,  $V_- = GND$ ,  $R_L = 1k\Omega$ ,  $R_G = 30\Omega$ ,  $R_F = 270\Omega$ . unless otherwise specified. Parameters are per amplifier.  
All values are at  $V_+ = 5V$ ,  $T_A = +25^\circ C$ .

PARAMETER	DESCRIPTION	CONDITIONS	MIN	TYP	MAX	UNIT
<b>AC SPECIFICATIONS</b>						
GBW	Gain Bandwidth Product	$A_V = +10$ ; $V_{OUT} = 100mV_{P-P}$ ; $R_f/R_g = 909\Omega/100\Omega$		800		MHz
HD (4MHz)	2nd Harmonic Distortion	$A_V = +10$ ; $V_{OUT} = 2V_{P-P}$ ; $R_f/R_g = 909\Omega/100\Omega$		-94		dBc
	3rd Harmonic Distortion			-104		dBc
ISO	Off-state Isolation; $\overline{EN} = 1$ ISL55291; EN = 0 ISL55191	$f_O = 10MHz$ ; $A_V = +10$ ; $V_{IN} = 640mV_{P-P}$ ; $R_f/R_g = 909\Omega/100\Omega$ ; $C_L = 1.2pF$		-65		dB
X-TALK ISL55291	Channel to Channel Crosstalk	$f_O = 10MHz$ ; $A_V = +10$ ; $V_{OUT}$ (Driven Channel) = $640mV_{P-P}$ ; $R_f/R_g = 909\Omega/100\Omega$ ; $C_L = 1.2pF$		-75		dB
$V_N$	Input Referred Voltage Noise	$f_O = 1kHz$		1.2		nV/ $\sqrt{Hz}$
IN	Input Referred Current Noise	$f_O = 10kHz$		3.8		pA/ $\sqrt{Hz}$
<b>TRANSIENT RESPONSE</b>						
SR	Slew Rate		150	260		V/ $\mu S$
$t_r, t_f$ Large Signal	Rise Time, $t_r$ 10% to 90%	$A_V = +10$ ; $V_{OUT} = 3.5V_{P-P}$ ; $R_f/R_g = 909\Omega/100\Omega$ $C_L = 1.2pF$		6.6		ns
	Fall Time, $t_f$ 10% to 90%			5.7		ns
	Rise Time, $t_r$ 10% to 90%	$A_V = +10$ ; $V_{OUT} = 1V_{P-P}$ ; $R_f/R_g = 909\Omega/100\Omega$ $C_L = 1.2pF$		5		ns
	Fall Time, $t_f$ 10% to 90%			4		ns
$t_r, t_f$ Small Signal	Rise Time, $t_r$ 10% to 90%	$A_V = +10$ ; $V_{OUT} = 100mV_{P-P}$ ; $R_f/R_g = 909\Omega/100\Omega$ $C_L = 1.2pF$		3		ns
	Fall Time, $t_f$ 10% to 90%			3		ns
$t_{pd}$	Propagation Delay 10% $V_{IN}$ to 10% $V_{OUT}$	$A_V = +10$ ; $V_{OUT} = 100mV_{P-P}$ ; $R_f/R_g = 909\Omega/100\Omega$ $C_L = 1.2pF$		1.6		ns
$t_{IOL}$	Positive Input Overload Recovery Time, $t_{IOL+}$ ; 10% $V_{IN}$ to 10% $V_{OUT}$	$V_S = \pm 2.5V$ ; $A_V = +10$ ; $V_{IN} = +V_{CM} + 0.5V$ ; $R_f/R_g = 909\Omega/100\Omega$ ; $C_L = 1.2pF$		50		ns
	Negative Input Overload Recovery Time, $t_{IOL-}$ ; 10% $V_{IN}$ to 10% $V_{OUT}$	$V_S = \pm 2.5V$ ; $A_V = +10$ ; $V_{IN} = -V - 0.5V$ ; $R_f/R_g = 909\Omega/100\Omega$ ; $C_L = 1.2pF$		30		ns
$t_{OOL}$	Positive Output Overload Recovery Time, $t_{OOL+}$ ; 10% $V_{IN}$ to 10% $V_{OUT}$	$V_S = \pm 2.5V$ ; $A_V = +10$ ; $V_{IN} = 2.3V_{P-P}$ ; $R_f/R_g = 909\Omega/100\Omega$ ; $C_L = 1.2pF$		40		ns
	Negative Output Overload Recovery Time, $t_{OOL-}$ ; 10% $V_{IN}$ to 10% $V_{OUT}$	$V_S = \pm 2.5V$ ; $A_V = +10$ ; $V_{IN} = 2.3V_{P-P}$ ; $R_f/R_g = 909\Omega/100\Omega$ ; $C_L = 1.2pF$		30		ns
$t_{EN}$ ISL55191	ENABLE to Output Turn-on Delay Time; 10% EN to 10% $V_{OUT}$	$A_V = +10$ ; $V_{IN} = 500mV_{P-P}$ ; $R_f/R_g = 909\Omega/100\Omega$ $C_L = 1.2pF$		540		ns
	ENABLE to Output Turn-off Delay Time; 10% EN to 10% $V_{OUT}$	$A_V = +10$ ; $V_{IN} = 500mV_{P-P}$ ; $R_f/R_g = 909\Omega/100\Omega$ $C_L = 1.2pF$		390		ns
$t_{\overline{EN}}$ ISL55291	ENABLE to Output Turn-on Delay Time; 10% $\overline{EN}$ to 10% $V_{OUT}$	$A_V = +10$ ; $V_{IN} = 500mV_{P-P}$ ; $R_f/R_g = 909\Omega/100\Omega$ $C_L = 1.2pF$		330		ns
	ENABLE to Output Turn-off Delay Time; 10% $\overline{EN}$ to 10% $V_{OUT}$	$A_V = +10$ ; $V_{IN} = 500mV_{P-P}$ ; $R_f/R_g = 909\Omega/100\Omega$ $C_L = 1.2pF$		50		ns

Typical Performance Curves

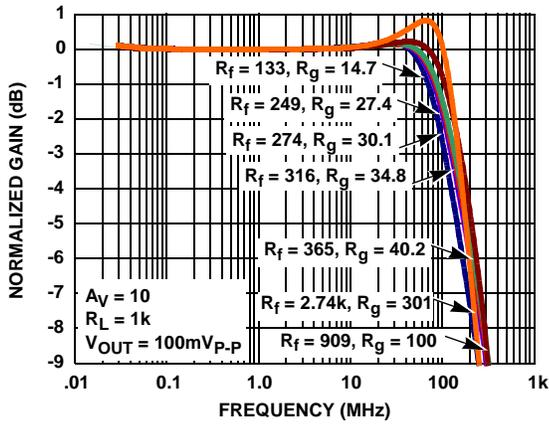

FIGURE 1. GAIN vs FREQUENCY FOR VARIOUS  $R_f$  vs  $R_g$

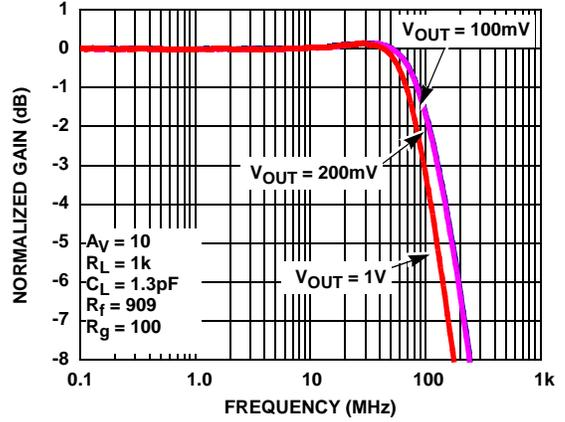

FIGURE 2. GAIN vs FREQUENCY vs  $V_{OUT}$

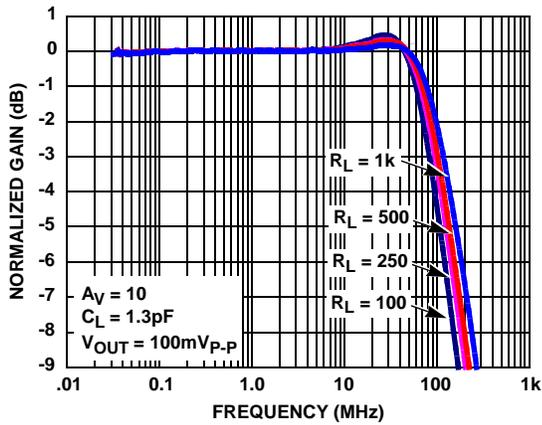

FIGURE 3. GAIN vs FREQUENCY FOR VARIOUS  $R_{LOAD}$

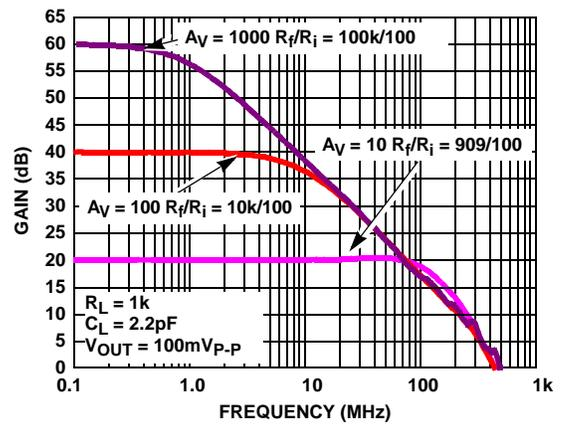

FIGURE 4. CLOSED LOOP GAIN vs FREQUENCY

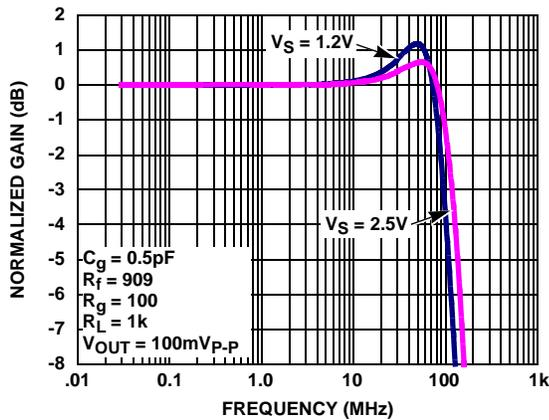

FIGURE 5. GAIN vs FREQUENCY vs  $V_S$

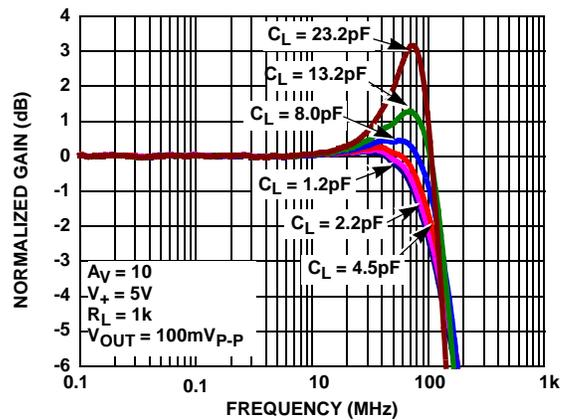

FIGURE 6. GAIN vs FREQUENCY FOR VARIOUS  $C_{LOAD}$

Typical Performance Curves (Continued)

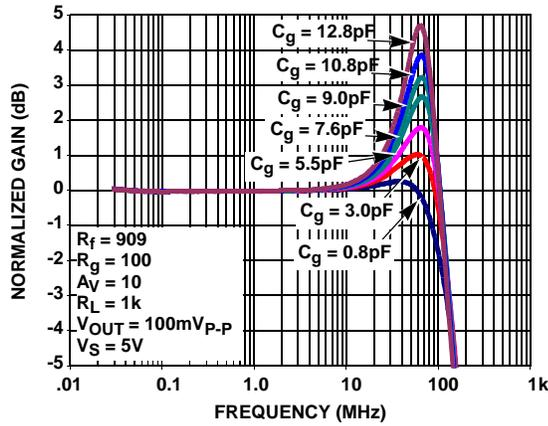

FIGURE 7. ISL55191 GAIN vs FREQUENCY FOR VARIOUS  $C_g$

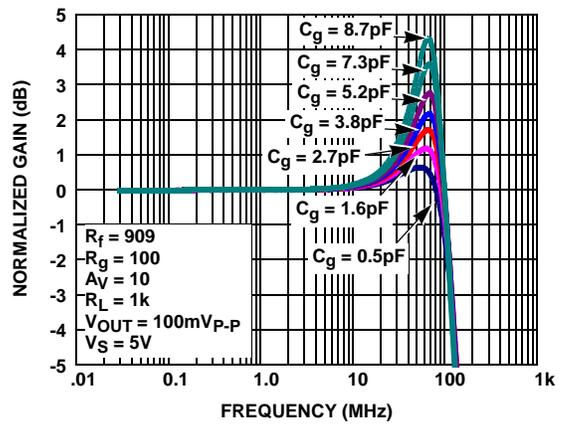

FIGURE 8. ISL55291 GAIN vs FREQUENCY FOR VARIOUS  $C_g$

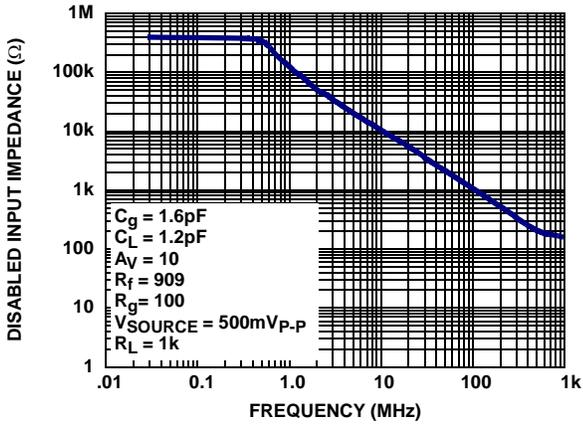

FIGURE 9. DISABLED INPUT IMPEDANCE vs FREQUENCY

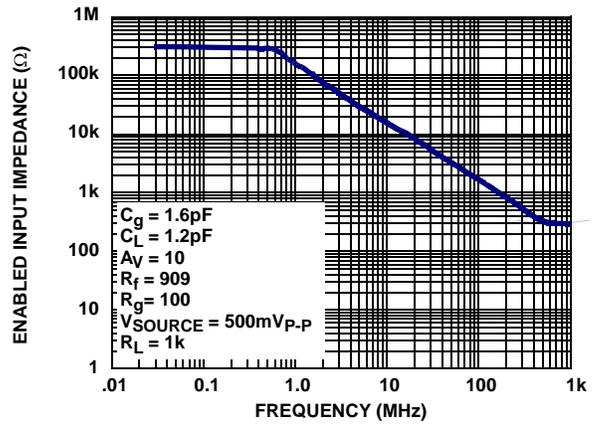

FIGURE 10. ENABLED INPUT IMPEDANCE vs FREQUENCY

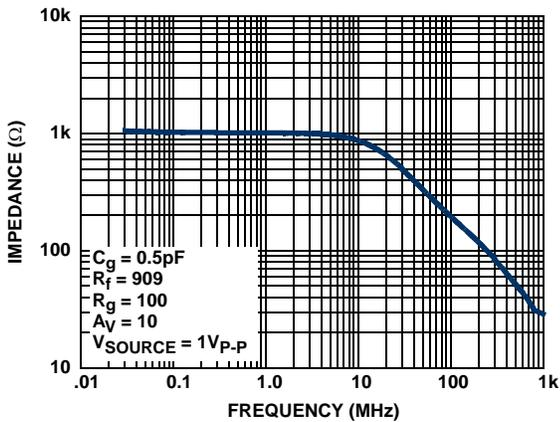

FIGURE 11. DISABLED OUTPUT IMPEDANCE vs FREQUENCY

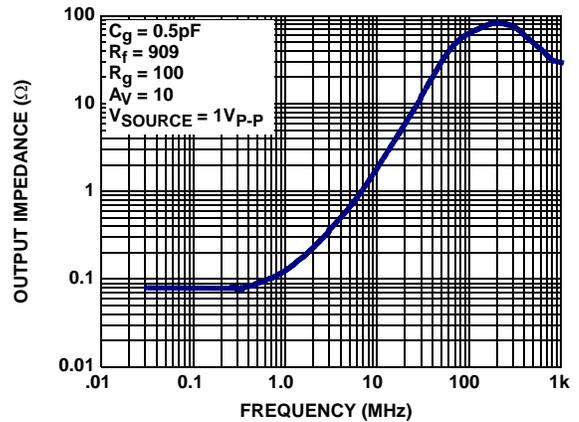

FIGURE 12. ENABLED OUTPUT IMPEDANCE vs FREQUENCY

Typical Performance Curves (Continued)

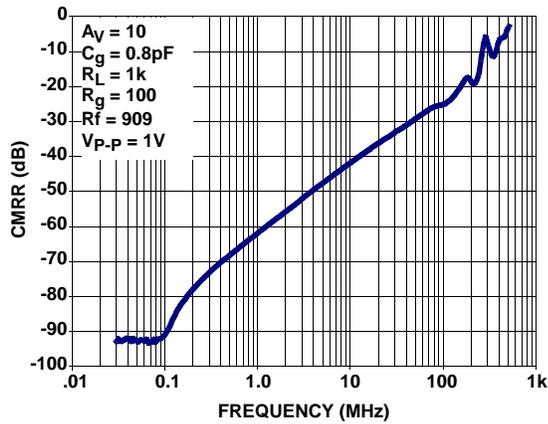

FIGURE 13. CMRR vs FREQUENCY

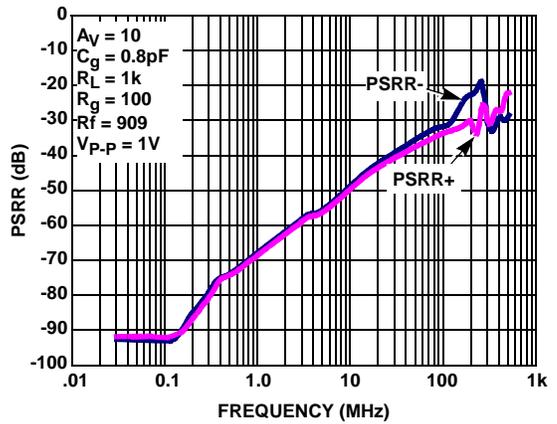

FIGURE 14. PSRR vs FREQUENCY

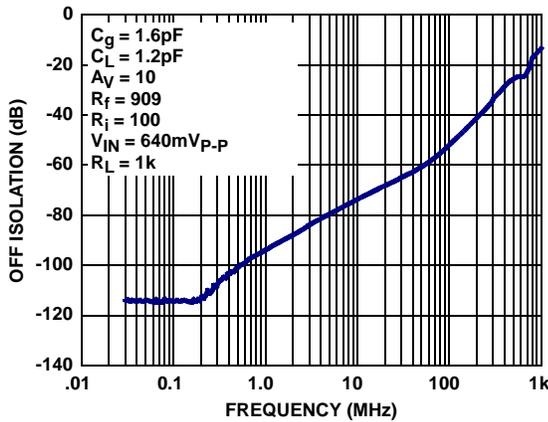

FIGURE 15. OFF ISOLATION vs FREQUENCY

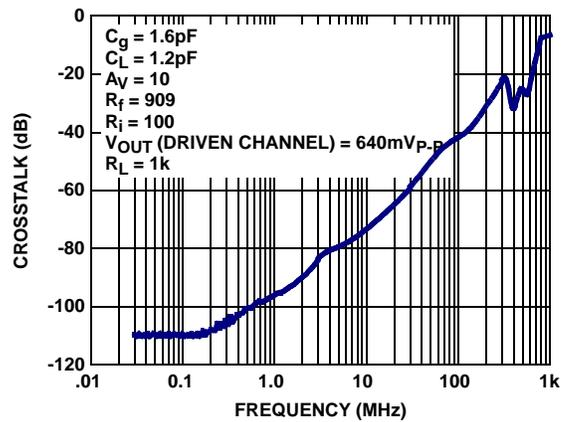

FIGURE 16. ISL55291 CHANNEL TO CHANNEL CROSSTALK vs FREQUENCY

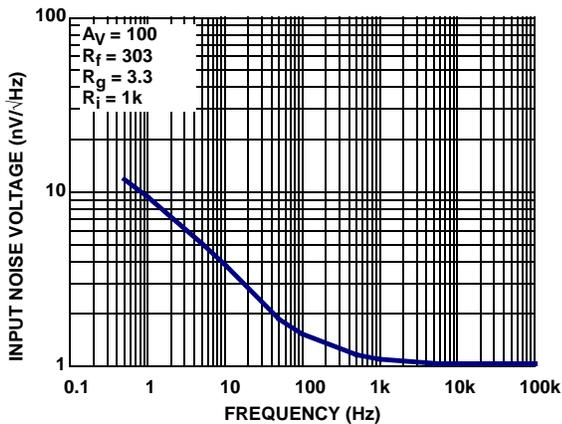

FIGURE 17. INPUT VOLTAGE NOISE vs FREQUENCY

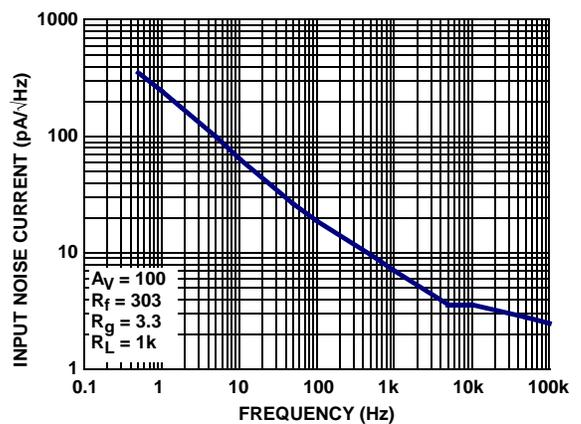

FIGURE 18. INPUT CURRENT NOISE vs FREQUENCY

Typical Performance Curves (Continued)

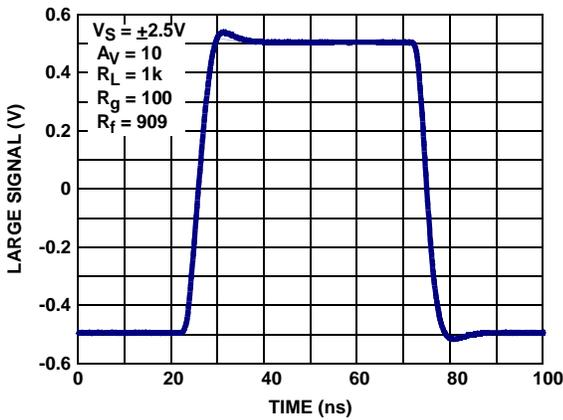

FIGURE 19. LARGE SIGNAL STEP RESPONSE

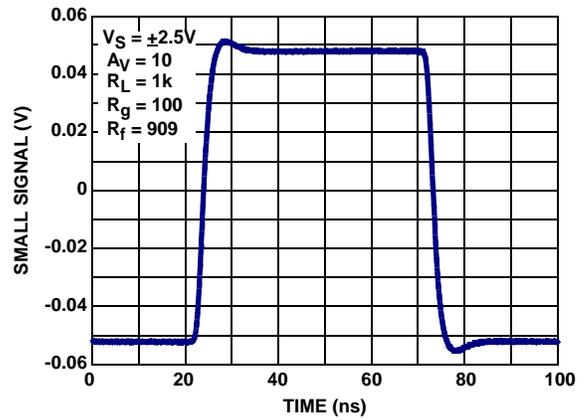

FIGURE 20. SMALL SIGNAL STEP RESPONSE

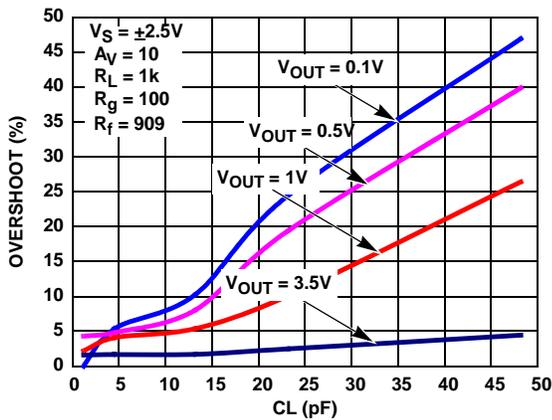

FIGURE 21. PERCENT OVERSHOOT FOR VARIOUS  $C_{LOAD}$

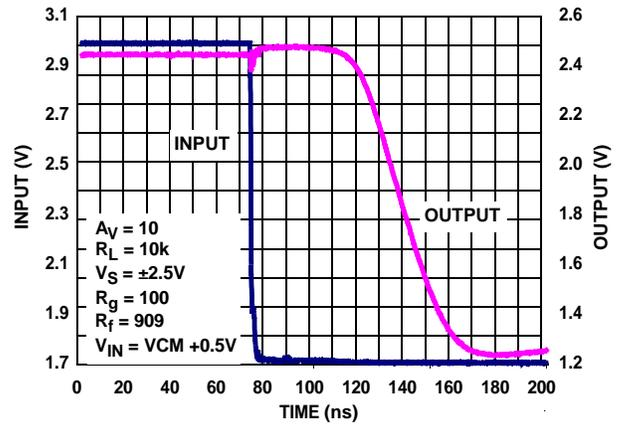

FIGURE 22. ISL55291 POSITIVE INPUT RECOVERY TIME

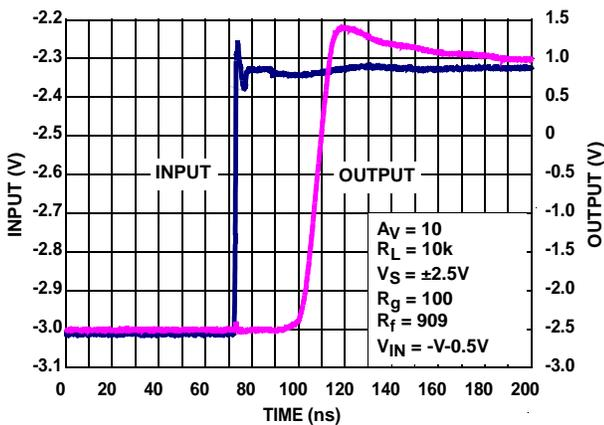

FIGURE 23. ISL55291 NEGATIVE INPUT RECOVERY RECOVERY

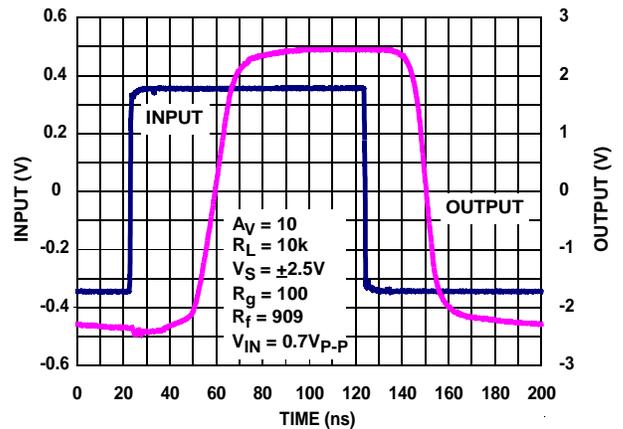

FIGURE 24. OUTPUT OVERLOAD RECOVERY

Typical Performance Curves (Continued)

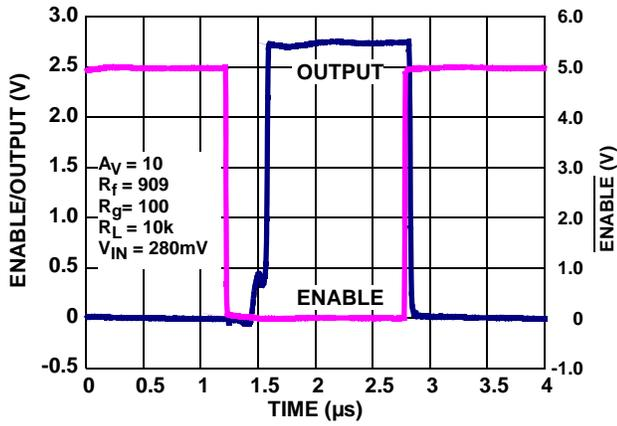

FIGURE 25. ENABLE TO OUTPUT DELAY

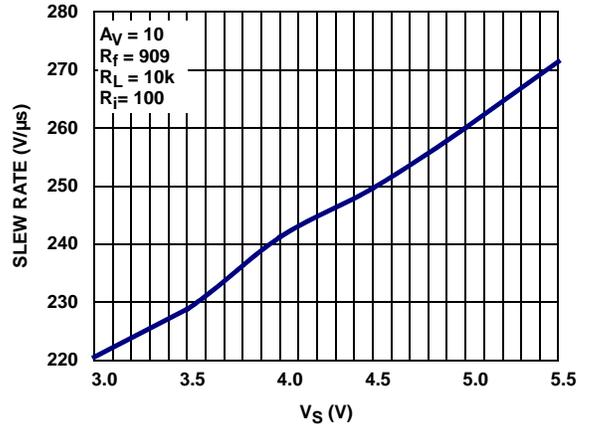

FIGURE 26. ISL55291 POSITIVE SLEW RATE vs  $V_S$

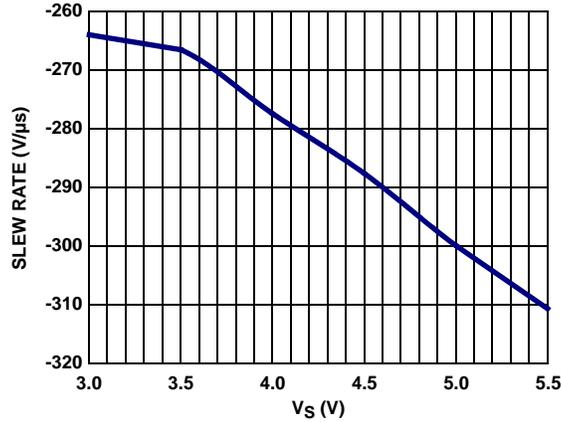

FIGURE 27. ISL55291 NEGATIVE SLEW RATE vs  $V_S$

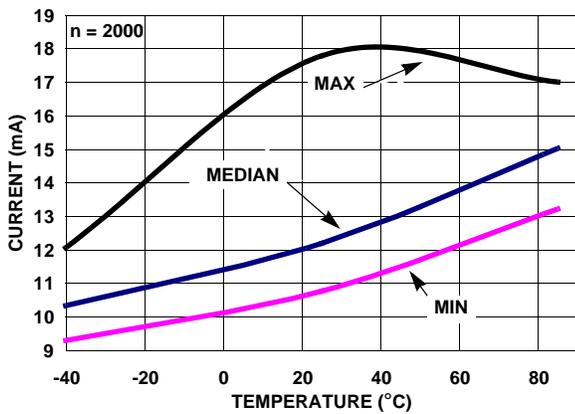

FIGURE 28. SUPPLY CURRENT ENABLED vs TEMPERATURE  $V_S = \pm 2.5V$

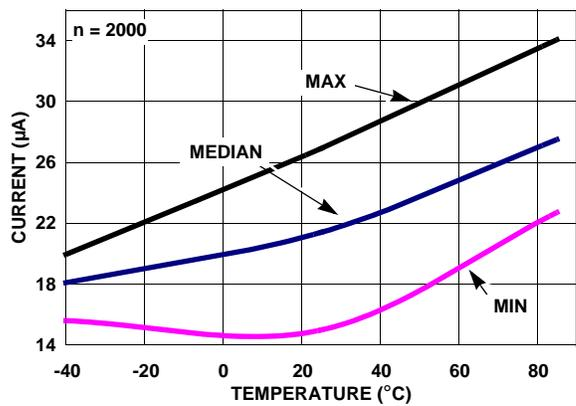

FIGURE 29. SUPPLY CURRENT DISABLED vs TEMPERATURE  $V_S = \pm 2.5V$

Typical Performance Curves (Continued)

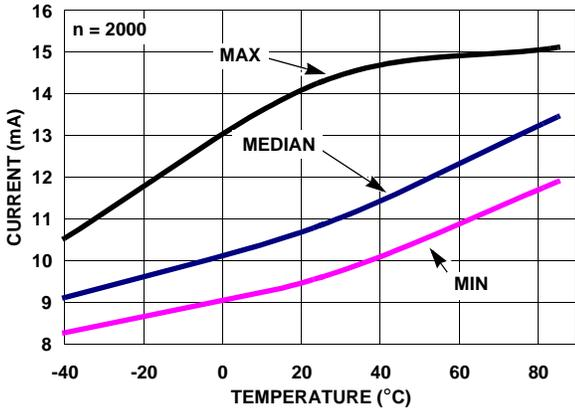

FIGURE 30. SUPPLY CURRENT ENABLED vs TEMPERATURE  $V_S = \pm 1.5V$

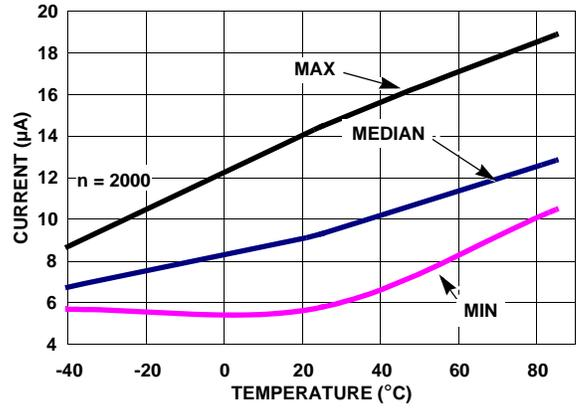

FIGURE 31. SUPPLY CURRENT DISABLED vs TEMPERATURE  $V_S = \pm 1.5V$

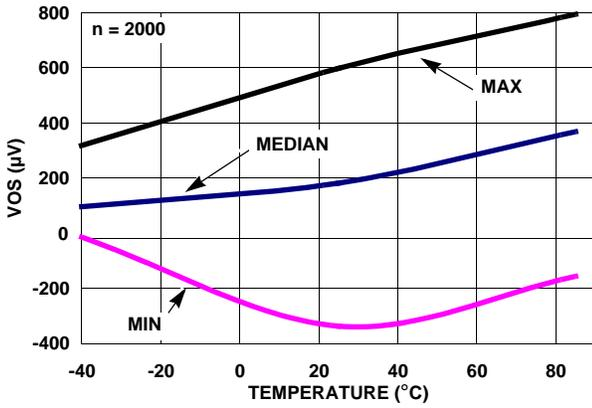

FIGURE 32. VIO vs TEMPERATURE  $V_S = \pm 2.5V$

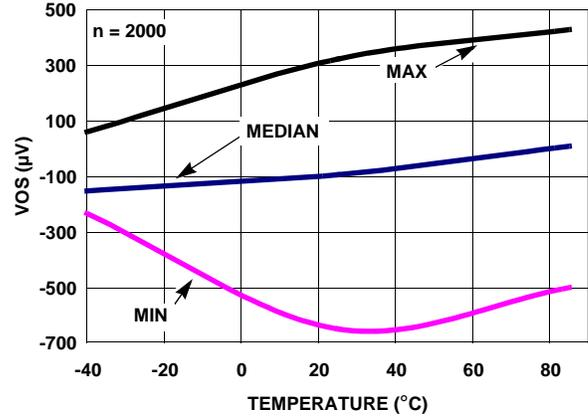

FIGURE 33. VIO vs TEMPERATURE  $V_S = \pm 1.5V$

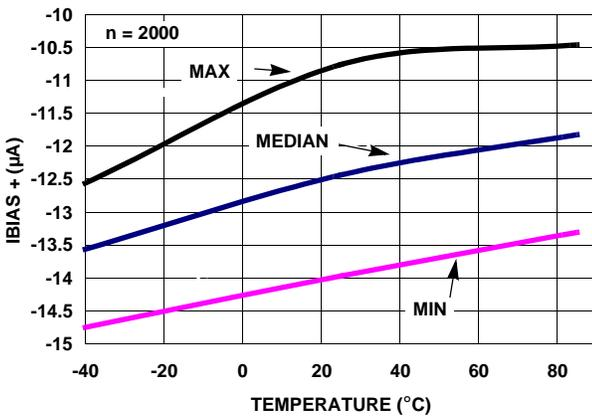

FIGURE 34.  $I_{BIAS+}$  vs TEMPERATURE  $V_S = \pm 2.5V$

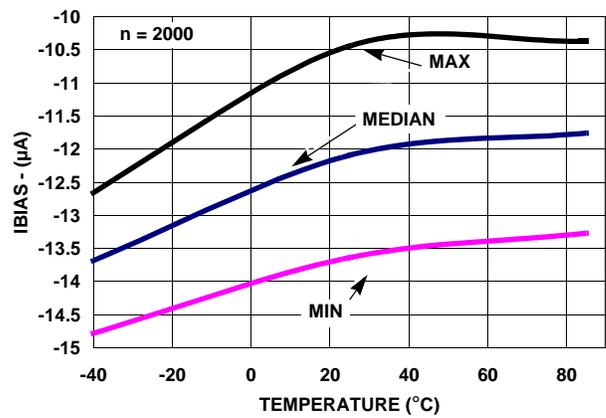

FIGURE 35.  $I_{BIAS-}$  vs TEMPERATURE  $V_S = \pm 2.5V$

Typical Performance Curves (Continued)

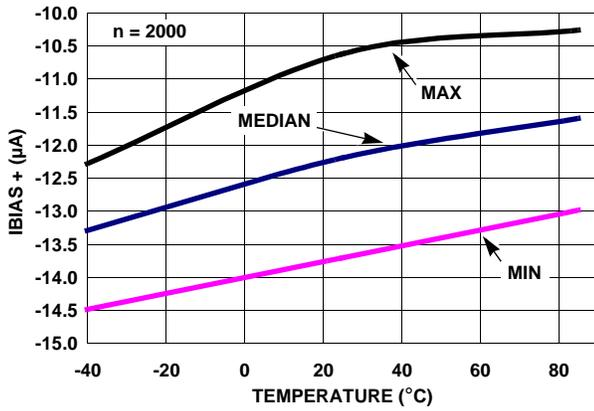

FIGURE 36.  $I_{BIAS+}$  vs TEMPERATURE  $V_S = \pm 1.5V$

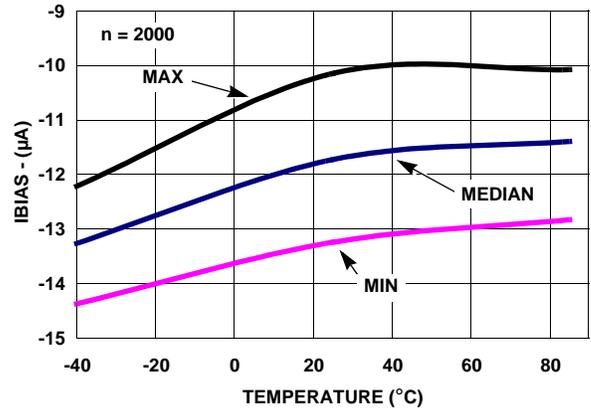

FIGURE 37.  $I_{BIAS-}$  vs TEMPERATURE  $V_S = \pm 1.5V$

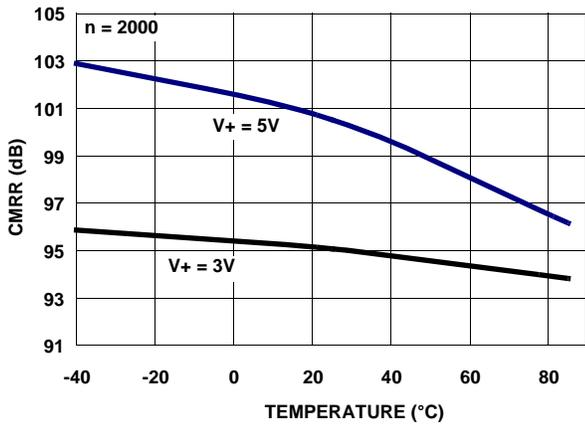

FIGURE 38. CMRR vs TEMPERATURE  $V+ = \pm 2.5V, \pm 1.5V$

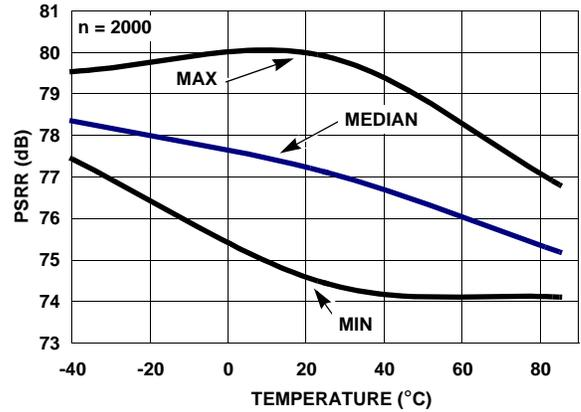

FIGURE 39. PSRR vs TEMPERATURE  $\pm 1.5V$  TO  $\pm 2.5V$

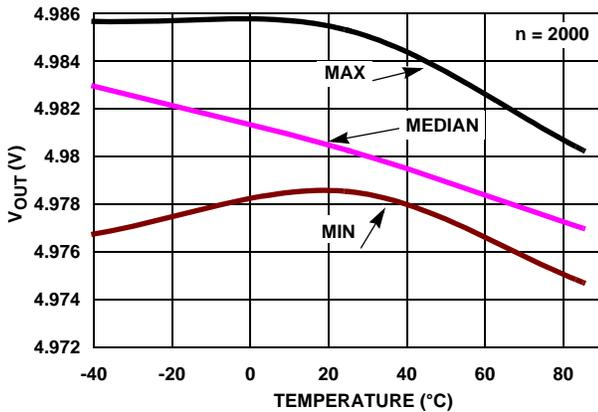

FIGURE 40.  $V_{OUT}$  HIGH vs TEMPERATURE  $V_S = \pm 2.5V, R_L = 1K$

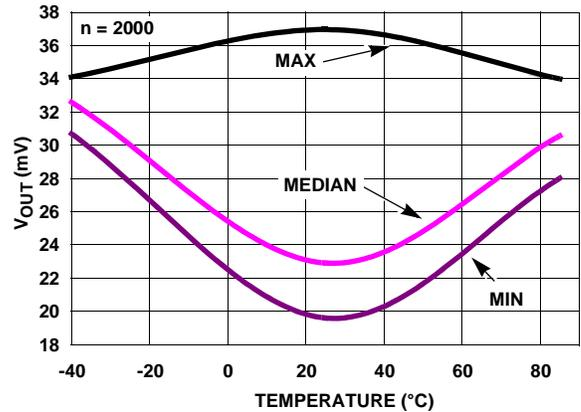

FIGURE 41.  $V_{OUT}$  LOW vs TEMPERATURE  $V_S = \pm 2.5V, R_L = 1k$

Typical Performance Curves (Continued)

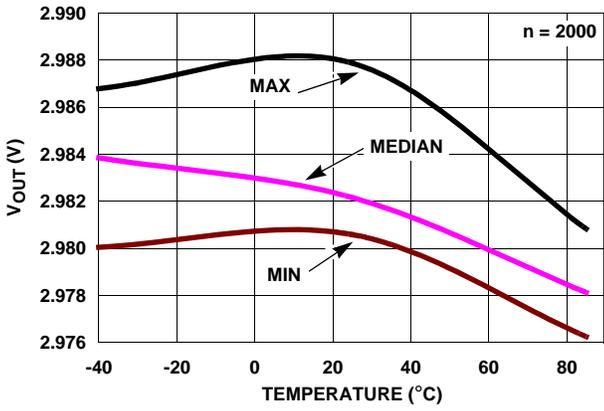

FIGURE 42. V<sub>OUT</sub> HIGH vs TEMPERATURE V<sub>S</sub> = ±1.5V, R<sub>L</sub> = 1k

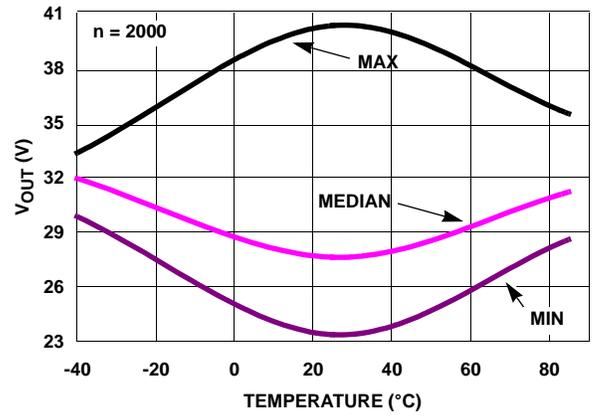

FIGURE 43. V<sub>OUT</sub> LOW vs TEMPERATURE V<sub>S</sub> = ±1.5V, R<sub>L</sub> = 1k

**Pin Descriptions**

ISL55191 (8 LD SOIC)	ISL55191 (8 LD DFN)	ISL55291 (10 LD MSOP)	PIN NAME	FUNCTION	EQUIVALENT CIRCUIT
5	6		NC	Not connected	
2	3	2 (A) 8 (B)	IN-	Inverting input	<p>Circuit 1</p>
3	4	3 (A) 7 (B)	IN+	Non-inverting input	(See circuit 1)
4	5	4	V-	Negative supply	
6	7	1 (A) 9 (B)	OUT	Output	<p>Circuit 2</p>
7	8	10	V+	Positive supply	
		5 (A) 6 (B)	$\overline{\text{EN}}$	Enable pin with internal pull-down referenced to the -V pin; Logic "1" selects the disabled state; Logic "0" selects the enabled state.	<p>Circuit 3a</p>
			EN	Enable pin with internal pull-down referenced to the -V pin; Logic "0" (-V) selects the disabled state; Logic "1" (+V) selects the enabled state.	<p>Circuit 3b</p>
1	2		FEEDBACK	Feedback pin to reduce IN-capacitance	<p>Circuit 4</p>

## Applications Information

### Product Description

The ISL55191 and ISL55291 are voltage feedback operational amplifiers designed for communication and imaging applications requiring very low voltage and current noise. Both parts features low distortion while drawing moderately low supply current. The ISL55191 and ISL55291 use a classical voltage-feedback topology which allows them to be used in a variety of applications where current-feedback amplifiers are not appropriate because of restrictions placed upon the feedback element used with the amplifier.

### Enable/Power-Down

Both devices can be operated from a single supply with a voltage range of +3V to +5V, or from split  $\pm 1.5V$  to  $\pm 2.5V$ . The logic level input to the ENABLE pins are TTL compatible and are referenced to the -V terminal in both single and split supply applications. The following discussion assumes single supply operation.

The ISL55191 uses a logic "0" ( $<0.8V$ ) to disable the amplifier and the ISL55291 uses a logic "1" ( $>2V$ ) to disable its amplifiers. In this condition, the output(s) will be in a high impedance state and the amplifier(s) current will be reduced to  $21\mu A$ . The ISL55191 has an internal pull-up on the EN pin and is enabled by either floating or tying the EN pin to a voltage  $>2V$ . The ISL55291 has internal pull-downs on the EN pins and are enabled by either floating or tying the EN pins to a voltage  $<0.8V$ . The enable pins should be tied directly to their respective supply pins when not being used ( $\overline{EN}$  tied to -V for the ISL55291 and EN tied to +V for the ISL55191).

### Current Limiting

The ISL55191 and ISL55291 have no internal current-limiting circuitry. If the output is shorted, it is possible to exceed the Absolute Maximum Rating for output current or power dissipation, potentially resulting in the destruction of the device.

### Power Dissipation

It is possible to exceed the  $+150^{\circ}C$  maximum junction temperatures under certain load and power-supply conditions. It is therefore important to calculate the maximum junction temperature ( $T_{JMAX}$ ) for all applications to determine if power supply voltages, load conditions, or package type need to be modified to remain in the safe operating area. These parameters are related as follows:

$$T_{JMAX} = T_{MAX} + (\theta_{JA} \times P_{DMAXTOTAL}) \quad (EQ. 1)$$

where:

- $P_{DMAXTOTAL}$  is the sum of the maximum power dissipation of each amplifier in the package ( $P_{DMAX}$ )
- $P_{DMAX}$  for each amplifier can be calculated as follows:

$$P_{DMAX} = 2 \times V_S \times I_{SMAX} + (V_S - V_{OUTMAX}) \times \frac{V_{OUTMAX}}{R_L} \quad (EQ. 2)$$

where:

- $T_{MAX}$  = Maximum ambient temperature
- $\theta_{JA}$  = Thermal resistance of the package
- $P_{DMAX}$  = Maximum power dissipation of 1 amplifier
- $V_S$  = Supply voltage
- $I_{MAX}$  = Maximum supply current of 1 amplifier
- $V_{OUTMAX}$  = Maximum output voltage swing of the application
- $R_L$  = Load resistance

### Power Supply Bypassing and Printed Circuit Board Layout

As with any high frequency device, good printed circuit board layout is necessary for optimum performance. Low impedance ground plane construction is essential. Surface mount components are recommended, but if leaded components are used, lead lengths should be as short as possible. The power supply pins must be well bypassed to reduce the risk of oscillation. The combination of a  $4.7\mu F$  tantalum capacitor in parallel with a  $0.01\mu F$  capacitor has been shown to work well when placed at each supply pin.

For good AC performance, parasitic capacitance should be kept to a minimum, especially at the inverting input. When ground plane construction is used, it should be removed from the area near the inverting input to minimize any stray capacitance at that node. Carbon or Metal-Film resistors are acceptable with the Metal-Film resistors giving slightly less peaking and bandwidth because of additional series inductance. Use of sockets (particularly for the SOIC package) should be avoided if possible. Sockets add parasitic inductance and capacitance which will result in additional peaking and overshoot.

For inverting gains, this parasitic capacitance has little effect because the inverting input is a virtual ground, but for non-inverting gains, this capacitance (in conjunction with the feedback and gain resistors) creates a pole in the feedback path of the amplifier. This pole, if low enough in frequency, has the same destabilizing effect as a zero in the forward open-loop response. The use of large-value feedback and gain resistors exacerbates the problem by further lowering the pole frequency (increasing the possibility of oscillation.).

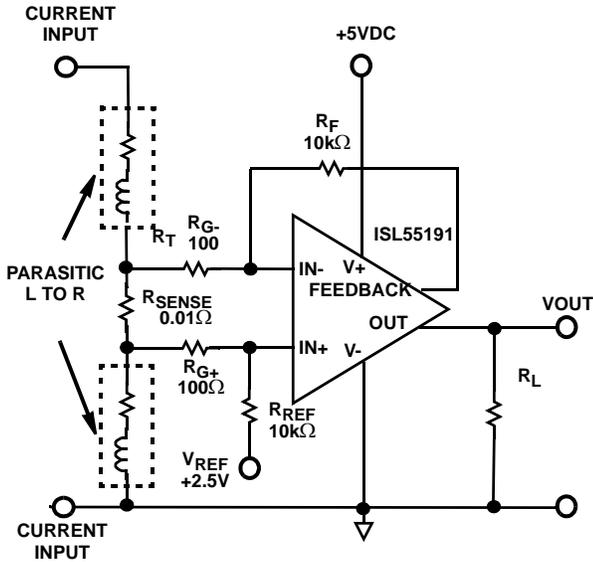

FIGURE 44. GROUND SIDE CURRENT SENSE AMPLIFIER

### Current Sense Application Circuit

The schematic in Figure 44 provides an example of utilizing the ISL55191 high speed performance with the ground sensing input capability to implement a single-supply,  $G = 10$  differential low side current sense amplifier. The reference voltage applied to  $V_{REF}$  (+2.5V) defines the amplifier output 0A current sense reference voltage at one half the supply voltage level ( $V_S = +5VDC$ ), and  $R_{SENSE}$  sets the current sense gain and full scale values. In this example the current gain is 10A/V over a maximum current range of slightly less than  $\pm 25A$  with  $R_{SENSE} = 0.01\Omega$ . The amplifier  $V_{IO}$  error (800 $\mu V$  max) and input bias offset current  $I_{IO}$  error (0.7 $\mu A$ ) together contribute less than 10mV (100mA) at the output for better than 0.2% full scale accuracy.

The amplifier's high slew rate and fast pulse response make this circuit suitable for low-side current sensing in PWM and motor control applications. The excellent input overload recovery response enables the circuit to maintain performance in the presence of parasitic inductance that cause fast rise and falling edge spikes that can momentarily overload the input stage of the amplifier.

Small Outline Package Family (SO)

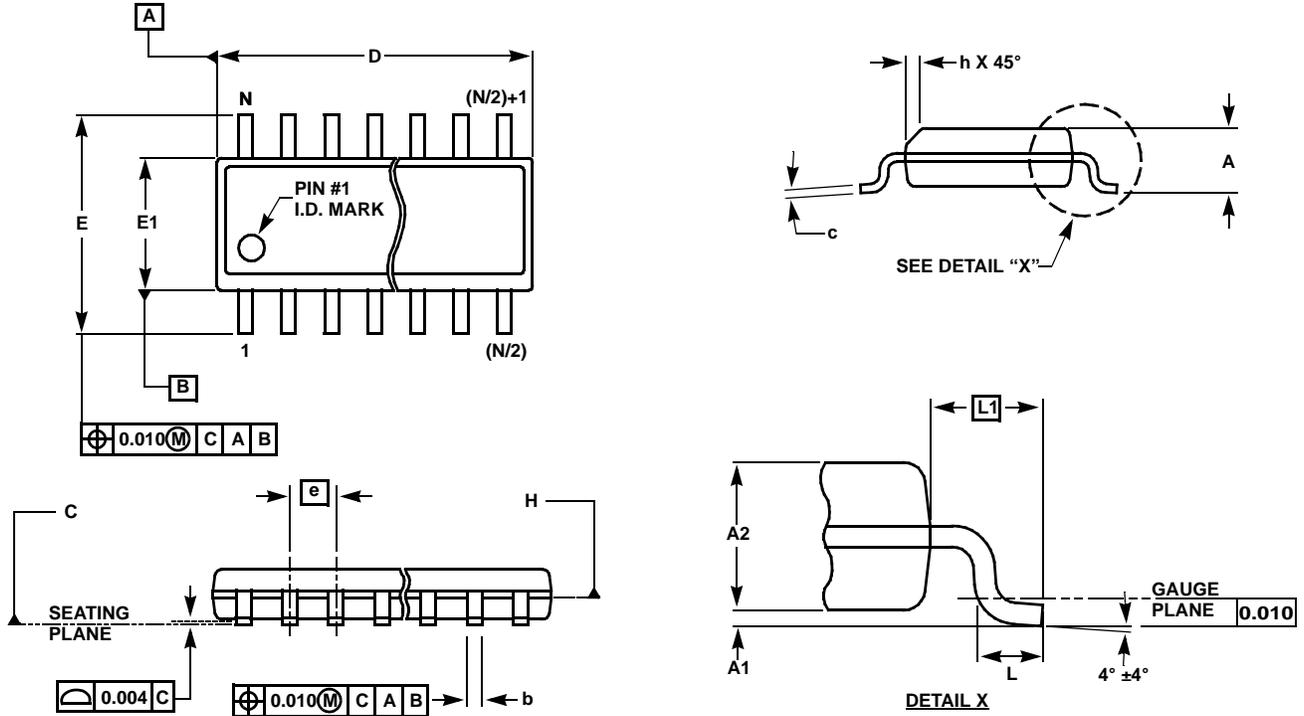

MDP0027

SMALL OUTLINE PACKAGE FAMILY (SO)

SYMBOL	INCHES							TOLERANCE	NOTES
	SO-8	SO-14	SO16 (0.150")	SO16 (0.300") (SOL-16)	SO20 (SOL-20)	SO24 (SOL-24)	SO28 (SOL-28)		
A	0.068	0.068	0.068	0.104	0.104	0.104	0.104	MAX	-
A1	0.006	0.006	0.006	0.007	0.007	0.007	0.007	$\pm 0.003$	-
A2	0.057	0.057	0.057	0.092	0.092	0.092	0.092	$\pm 0.002$	-
b	0.017	0.017	0.017	0.017	0.017	0.017	0.017	$\pm 0.003$	-
c	0.009	0.009	0.009	0.011	0.011	0.011	0.011	$\pm 0.001$	-
D	0.193	0.341	0.390	0.406	0.504	0.606	0.704	$\pm 0.004$	1, 3
E	0.236	0.236	0.236	0.406	0.406	0.406	0.406	$\pm 0.008$	-
E1	0.154	0.154	0.154	0.295	0.295	0.295	0.295	$\pm 0.004$	2, 3
e	0.050	0.050	0.050	0.050	0.050	0.050	0.050	Basic	-
L	0.025	0.025	0.025	0.030	0.030	0.030	0.030	$\pm 0.009$	-
L1	0.041	0.041	0.041	0.056	0.056	0.056	0.056	Basic	-
h	0.013	0.013	0.013	0.020	0.020	0.020	0.020	Reference	-
N	8	14	16	16	20	24	28	Reference	-

Rev. M 2/07

NOTES:

1. Plastic or metal protrusions of 0.006" maximum per side are not included.
2. Plastic interlead protrusions of 0.010" maximum per side are not included.
3. Dimensions "D" and "E1" are measured at Datum Plane "H".
4. Dimensioning and tolerancing per ASME Y14.5M-1994

# Package Outline Drawing

## L8.3x3D

8 LEAD DUAL FLAT NO-LEAD PLASTIC PACKAGE (DFN)

Rev 0, 9/06

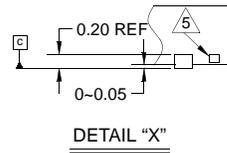
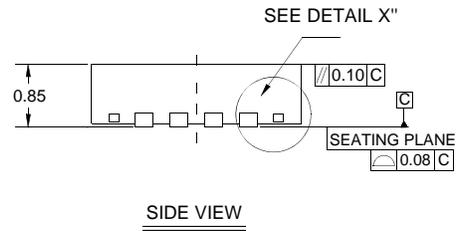
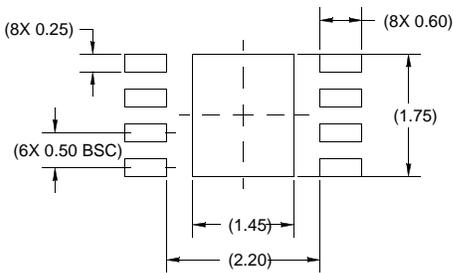
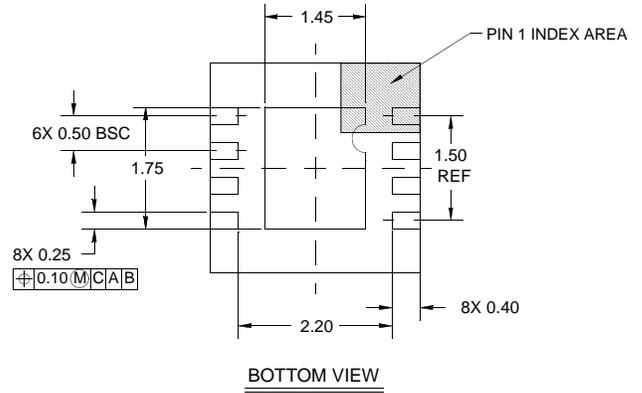
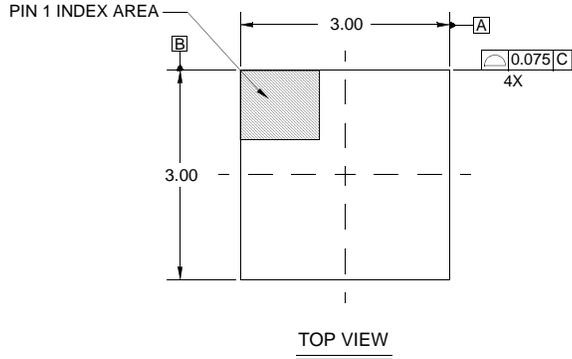

**NOTES:**

1. Controlling dimensions are in mm.  
Dimensions in ( ) for reference only.
2. Unless otherwise specified, tolerance : Decimal  $\pm 0.05$   
Angular  $\pm 2^\circ$
3. Dimensioning and tolerancing conform to JEDEC STD MO220-D.
4. The configuration of the pin #1 identifier is optional, but must be located within the zone indicated. The pin #1 identifier may be either a mold or mark feature.
5. Tiebar shown (if present) is a non-functional feature.

Mini SO Package Family (MSOP)

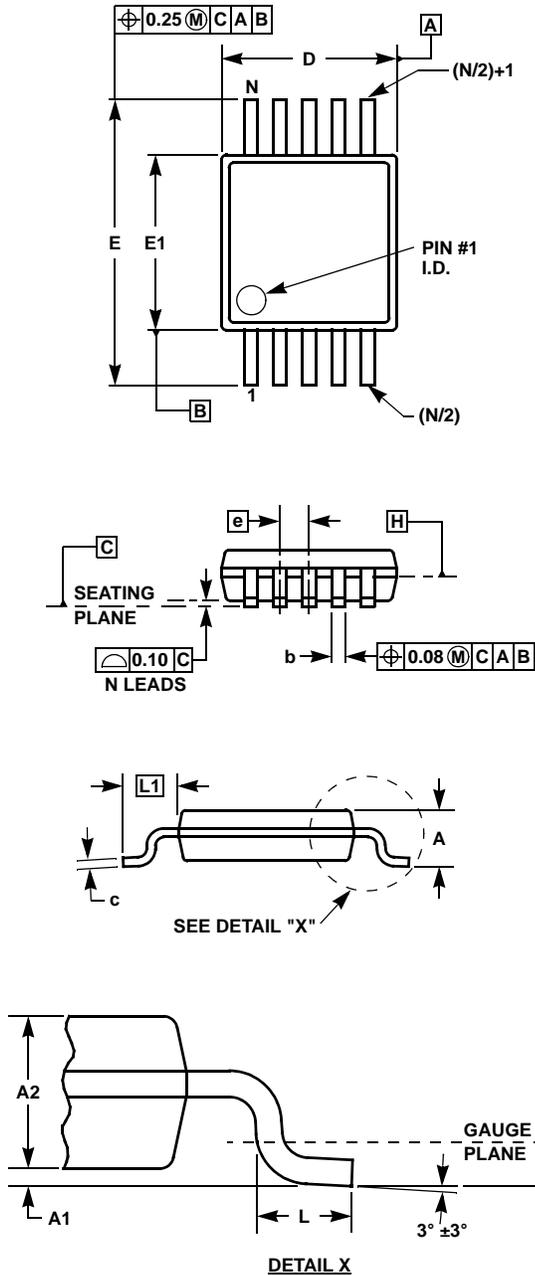

MDP0043  
MINI SO PACKAGE FAMILY

SYMBOL	MILLIMETERS		TOLERANCE	NOTES
	MSOP8	MSOP10		
A	1.10	1.10	Max.	-
A1	0.10	0.10	±0.05	-
A2	0.86	0.86	±0.09	-
b	0.33	0.23	+0.07/-0.08	-
c	0.18	0.18	±0.05	-
D	3.00	3.00	±0.10	1, 3
E	4.90	4.90	±0.15	-
E1	3.00	3.00	±0.10	2, 3
e	0.65	0.50	Basic	-
L	0.55	0.55	±0.15	-
L1	0.95	0.95	Basic	-
N	8	10	Reference	-

Rev. D 2/07

NOTES:

1. Plastic or metal protrusions of 0.15mm maximum per side are not included.
2. Plastic interlead protrusions of 0.25mm maximum per side are not included.
3. Dimensions "D" and "E1" are measured at Datum Plane "H".
4. Dimensioning and tolerancing per ASME Y14.5M-1994.

All Intersil U.S. products are manufactured, assembled and tested utilizing ISO9000 quality systems. Intersil Corporation's quality certifications can be viewed at [www.intersil.com/design/quality](http://www.intersil.com/design/quality)

Intersil products are sold by description only. Intersil Corporation reserves the right to make changes in circuit design, software and/or specifications at any time without notice. Accordingly, the reader is cautioned to verify that data sheets are current before placing orders. Information furnished by Intersil is believed to be accurate and reliable. However, no responsibility is assumed by Intersil or its subsidiaries for its use; nor for any infringements of patents or other rights of third parties which may result from its use. No license is granted by implication or otherwise under any patent or patent rights of Intersil or its subsidiaries.

For information regarding Intersil Corporation and its products, see [www.intersil.com](http://www.intersil.com)