

Alle Rechte vorbehalten/ All rights reserved

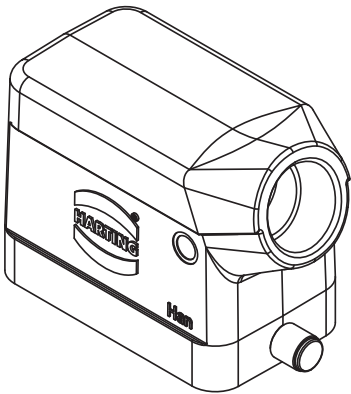
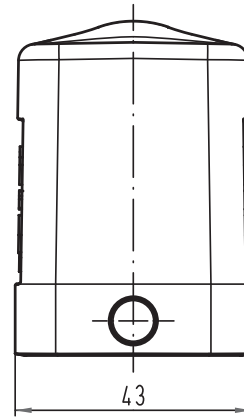
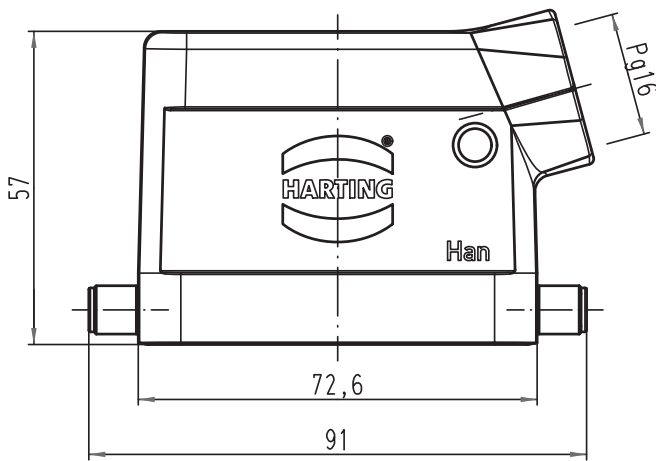

All Dimensions in mm Original Size DIN A 4		Techn. Character.			Nicht tolerierte Maß/Free size tolerances	
			Dat.	Name	Maßstab/Scale 1:1	Han 3HvE-gs-R-16 Tüllengehäuse <i>hood</i>
			Detail.	20.12.10 Spr		
			Insp.	Be		
			Stand.			
A			HARTING Electric GmbH & Co. KG			TB 09 34 003 0504 Sub. TB 09 34 003 0504 v. 03.09.03
Mod.	Dat.	Name	D-32339 Espelkamp			
						Blatt/page