

INNER PANEL

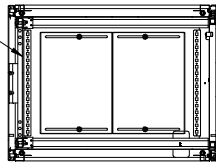

SECTION A-A

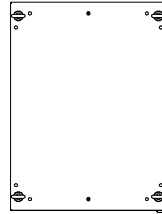

TOP VIEW

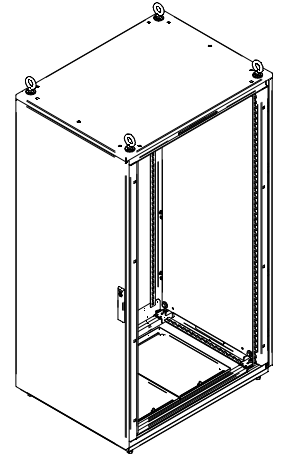

ISOMETRIC

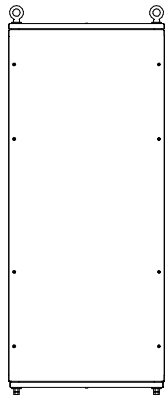

REAR VIEW

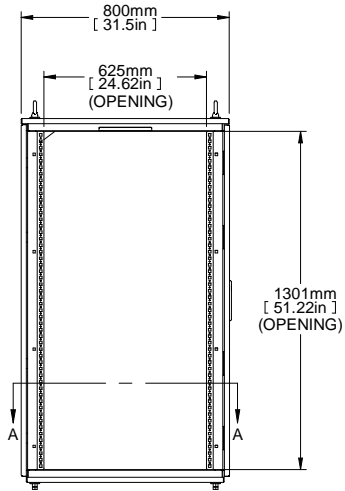

L.S. VIEW

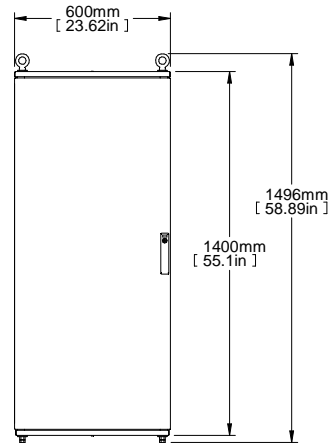

FRONT VIEW

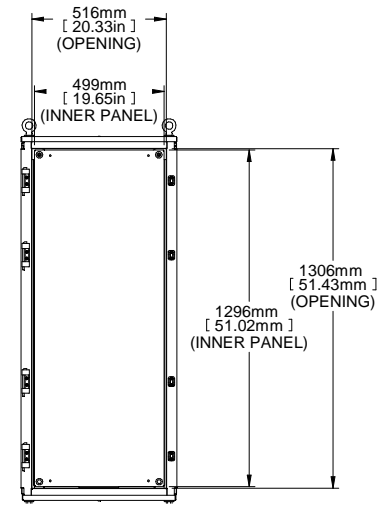

FRONT VIEW
DOOR REMOVED

312mm
[12.27in]
GLAND PLATE
CUT-OUT

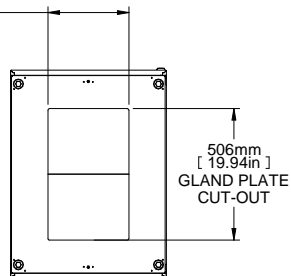

BOTTOM VIEW

PART NUMBERS	
HME1468	PAINTED TEXTURED GRAY RAL7035
NOTES	
Welded Assembly.	
See Hammond Website for Additional Accessories.	
Français	
Pour tous les détails sur nos produits, svp veuillez consulter notre site www.hammondmfg.com	
Data subject to change without notice. Isometric drawing not to scale. Les données sont sujettes à changement sans préavis.	
	HAMMOND MANUFACTURING® www.hammondmfg.com
PART NO.	HME1468