

KEMET Part Number: T491B335M025ZG **Obsolete**
(B45198H5335M209)

B45198H, Tantalum, MnO2 Tantalum, 3.3 uF, 20%, 25 V, SMD, Molded, 3528, Height Max = 2.1mm

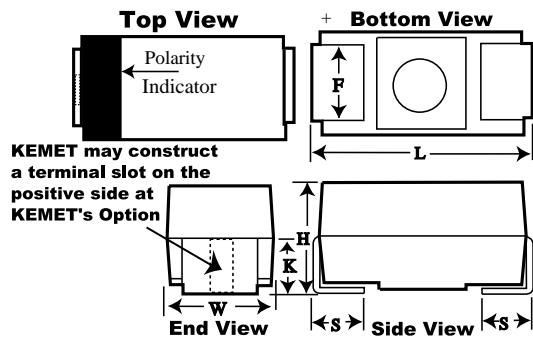

General Information	
Supplier:	KEMET
Series:	B45198H
Dielectric:	MnO2 Tantalum
Style:	SMD Chip
Description:	SMD, Molded
RoHS:	Yes
Termination:	Gold
Notes:	Old Part Number [Obsolete] Was B45198H5335M209

Dimensions	
Footprint	3528
L	3.5mm +/-0.2mm
W	2.8mm +/-0.2mm
H	1.9mm +/-0.2mm
S	0.7mm +/-0.3mm
F	2.2mm +/-0.1mm
K	1.4mm TYP

Specifications	
Capacitance:	3.3 uF
Capacitance Tolerance:	20%
Voltage DC:	25 VDC (85C), 16.75 VDC (125C)
Temperature Range:	-55/+125C
Rated Temperature:	85C
Dissipation Factor:	6%
Failure Rate:	N/A
Leakage Current:	0.8 uA

Packaging Specifications	
Packaging:	T&R, 178mm
Packaging Quantity:	2000