

# G9EC-1

DC Power Relays (200-A Models)



## DC Power Relays Capable of Interrupting High-voltage, High-current Loads

- A compact relay (98 x 44 x 86.7 mm (L x W x H)) capable of switching 400-V 200-A DC loads. (Capable of interrupting 1,000 A at 400 VDC max.)
- The switching section and driving section are gas-injected and hermetically sealed, allowing these compact relays to interrupt high-capacity loads. The sealed construction also requires no arc space, saves space, and helps ensure safe applications.
- Downsizing and optimum design allow no restrictions on the mounting direction.
- Terminal Cover is also available for industrial applications.
- UL/CSA standard UL508 approved.

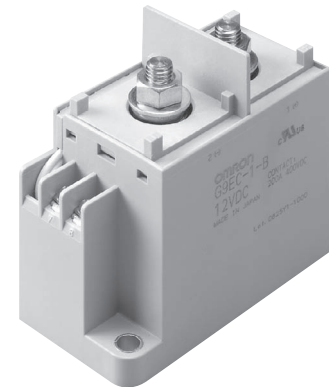

**RoHS Compliant**



Refer to "DC Power Relays Common Precautions".

### Model Number Legend

G9MC- $\square$ - $\square$ - $\square$ - $\square$   
 $\frac{1}{1}$   $\frac{2}{2}$   $\frac{3}{3}$   $\frac{4}{4}$

#### 1. Number of Poles

1: 1 pole

#### 2. Contact Form

Blank: SPST-NO

#### 3. Coil Terminals

B : M3.5 screw terminals (standard)

Blank: Lead wire output

#### 4. Special Functions

### List of Models

Models	Terminals		Contact form	Coil rated voltage	Model
	Coil terminals	Contact terminals			
Switching/current conduction models	Screw terminals	Screw terminals	SPST-NO	12 VDC	G9EC-1-B
	Lead wire			24 VDC	
				48 VDC	
				60 VDC	G9EC-1
				100 VDC	

Note 1. Two M8 nuts are provided for the contact terminal connection.

Note 2. Two M3.5 screws are provided for the coil terminal connection.

### Ratings

#### Coil

Rated voltage	Item	Rated current (mA)	Coil resistance ( $\Omega$ )	Must-operate voltage (V)	Must-release voltage (V)	Maximum voltage (V)	Power consumption (W)
12 VDC		938	12.8	75% max. of rated voltage	8% min. of rated voltage	110% of rated voltage (at 23°C within 10 minutes)	Approx. 11
24 VDC		469	51.2				
48 VDC		234	204.8				
60 VDC		188	320.0				
100 VDC		113	888.9				

Note 1. The figures for the rated current and coil resistance are for a coil temperature of 23°C and have a tolerance of  $\pm 10\%$ .

Note 2. The figures for the operating characteristics are for a coil temperature of 23°C.

Note 3. The figure for the maximum voltage is the maximum voltage that can be applied to the relay coil.

#### Contacts

Item	Resistive load
	G9EC-1(-B)
Rated load	200 A at 400 VDC
Rated carry current	200 A
Maximum switching voltage	400 V
Maximum switching current	200 A

### ■ Characteristics

Item	Model	G9EC-1(-B)
Contact resistance *1		30 mΩ max. (0.2 mΩ typical)
Contact voltage drop		0.1 V max. (for a carry current of 200 A)
Operate time		50 ms max.
Release time		30 ms max.
Insulation resistance *2	Between coil and contacts	1,000 MΩ min.
	Between contacts of the same polarity	1,000 MΩ min.
Dielectric strength	Between coil and contacts	2,500 VAC, 1 min
	Between contacts of the same polarity	2,500 VAC, 1 min
Impulse withstand voltage *3		4,500 V
Vibration resistance	Destruction	10 to 55 to 10 Hz 0.75-mm single amplitude (Acceleration: 2.94 to 88.9 m/s <sup>2</sup> )
	Malfunction	10 to 55 to 10 Hz 0.75-mm single amplitude (Acceleration: 2.94 to 88.9 m/s <sup>2</sup> )
Shock resistance	Destruction	490 m/s <sup>2</sup>
	Malfunction	196 m/s <sup>2</sup>
Mechanical endurance *4		200,000 operations min.
Electrical endurance (resistive load) *5		400 VDC, 200 A, 3,000 operations min.
Short-time carry current		300 A (15 min)
Maximum interruption current		1,000 A at 400 VDC (10 times)
Overload interruption		700 A at 400 VDC (40 times min.)
Reverse polarity interruption		-200 A at 200 VDC (1,000 times min.)
Ambient operating temperature		-40 to 50°C (with no icing or condensation)
Ambient operating humidity		5% to 85%
Weight (Including accessories)		Approx. 560 g

Note. The above values are initial values at an ambient temperature of 23°C unless otherwise specified.

\*1. The contact resistance was measured with 1 A at 5 VDC using the voltage drop method.

\*2. The insulation resistance was measured with a 500-VDC megohmmeter.

\*3. The impulse withstand voltage was measured with a JEC-212 (1981) standard impulse voltage waveform (1.2 x 50 μs).

\*4. The mechanical endurance was measured at a switching frequency of 3,600 operations/hr.

\*5. The electrical endurance was measured at a switching frequency of 60 operations/hr.

## Engineering Data

### G9EC-1(-B) Switching/Current Conduction Models

#### Maximum Switching Capacity

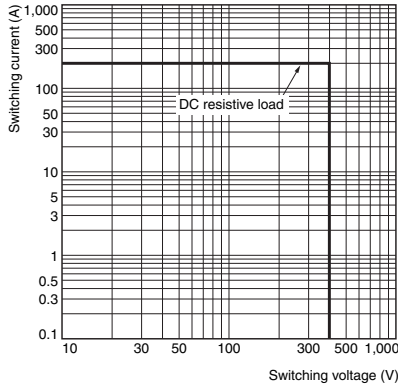

#### Carry Current vs Energizing Time

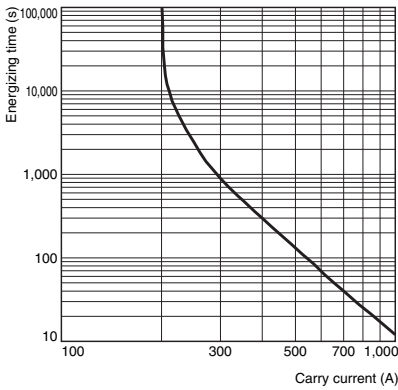

#### Vibration Malfunction

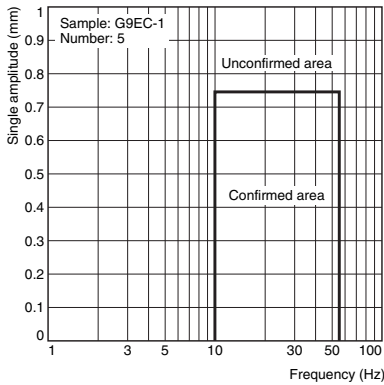

#### Shock Malfunction

Unit: m/s<sup>2</sup>  
Sample: G9EC-1  
Number: 5

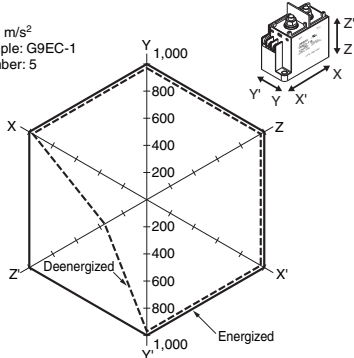

The value at which malfunction occurred was measured after applying shock to the test piece 3 times each in 6 directions along 3 axes.

#### Electrical Endurance (Switching Performance)

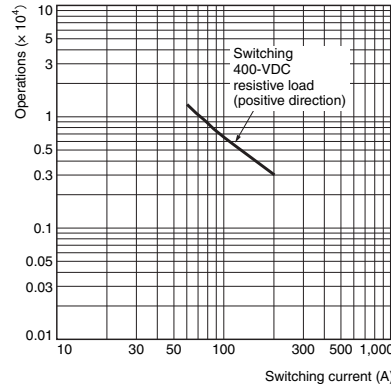

#### Must-operate Voltage and Must-release Voltage Distributions

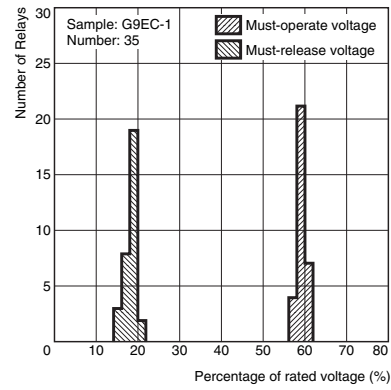

#### Vibration Resistance

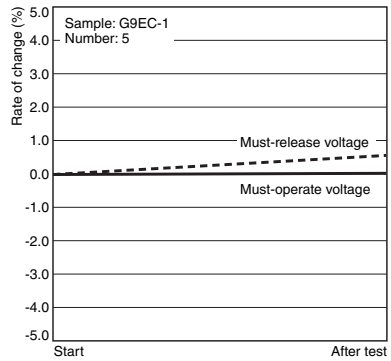

Characteristics were measured after applying vibration at a frequency of 10 to 55 Hz (single amplitude of 0.75 mm) to the test piece (not energized) for 2 hours each in 3 directions. The percentage rate of change is the average value for all of the samples.

#### Shock Resistance

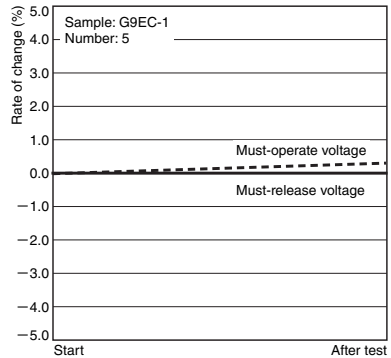

Characteristics were measured after applying a shock of 490 m/s<sup>2</sup> to the test piece 3 times each in 6 directions along 3 axes. The percentage rate of change is the average value for all of the samples.

#### Electrical Endurance (Interruption Performance)

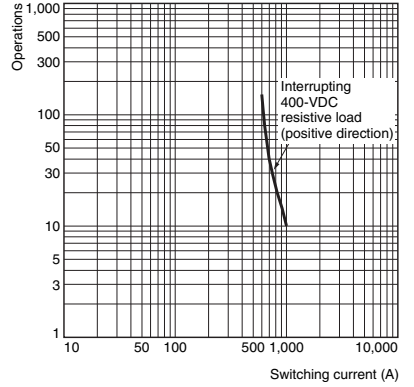

#### Time Characteristic Distributions

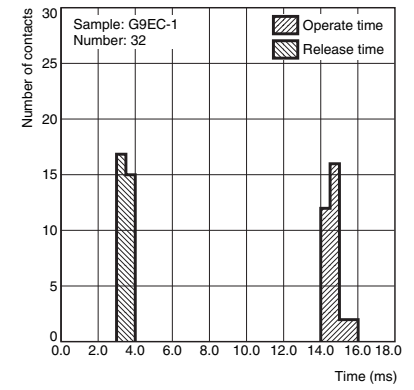

# G9EC-1

## DC Power Relays (200-A Models)

### ■Dimensions (Unit: mm)

#### ●Models with Screw Terminals G9EC-1-B

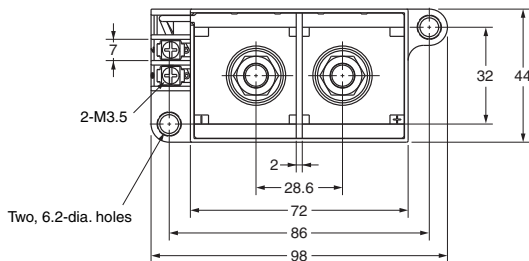
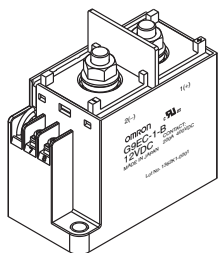

#### Terminal Arrangement/ Internal Connections (TOP VIEW)

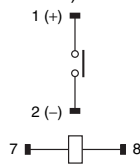

Note: Be sure to connect terminals with the correct polarity. Coils do not have polarity.

#### Mounting Hole Dimensions (TOP VIEW)

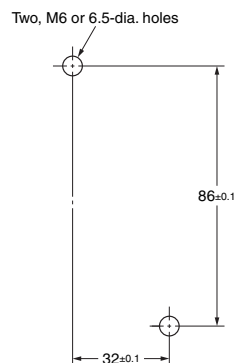

Dimension (mm)	Tolerance (mm)
10 or lower	±0.3
10 to 50	±0.5
50 or higher	±1

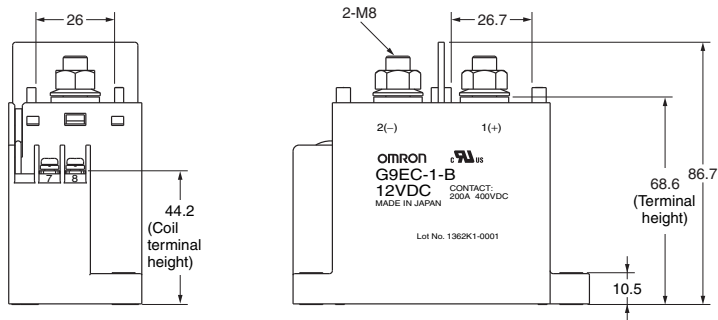

#### ●Models with Lead Wires G9EC-1

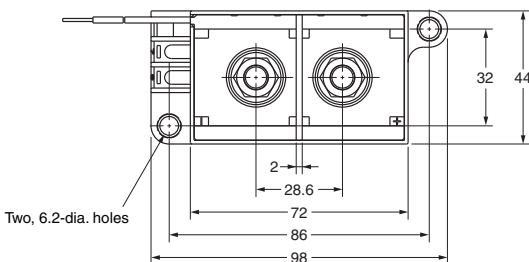
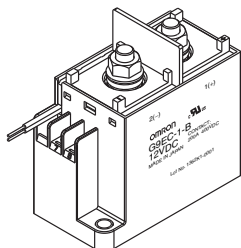

#### Terminal Arrangement/ Internal Connections (TOP VIEW)

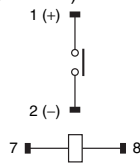

Note: Be sure to connect terminals with the correct polarity. Coils do not have polarity.

#### Mounting Hole Dimensions (TOP VIEW)

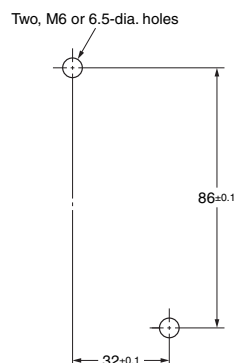

Dimension (mm)	Tolerance (mm)
10 or lower	±0.3
10 to 50	±0.5
50 or higher	±1

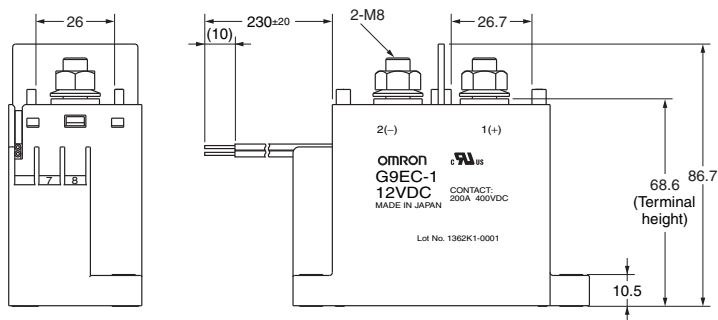

### ■Options (Unit: mm)

#### ●Terminal Cover P9EC-C

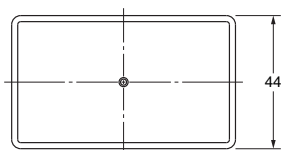
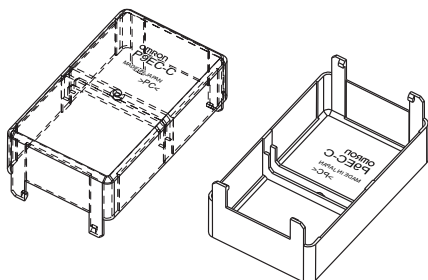

\* Dimensions of cutout for wiring.

Note: Be sure to remove the cutouts for wiring that are located in the wiring outlet direction before installing the Terminal Cover.

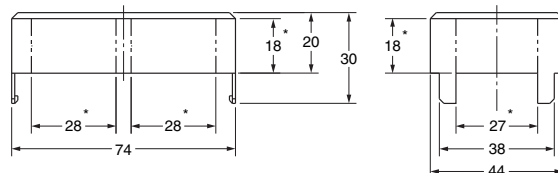

Dimension (mm)	Tolerance (mm)
10 or lower	±0.3
10 to 50	±0.5
50 or higher	±1

- Application examples provided in this document are for reference only. In actual applications, confirm equipment functions and safety before using the product.
- Consult your OMRON representative before using the product under conditions which are not described in the manual or applying the product to nuclear control systems, railroad systems, aviation systems, vehicles, combustion systems, medical equipment, amusement machines, safety equipment, and other systems or equipment that may have a serious influence on lives and property if used improperly. Make sure that the ratings and performance characteristics of the product provide a margin of safety for the system or equipment, and be sure to provide the system or equipment with double safety mechanisms.

**Note: Do not use this document to operate the Unit.**