

Technical Data Sheet

Opto Interrupter

EAITRBA1

Features

- Fast response time
- High analytic
- High sensitivity
- Cut-off visible wavelength $\lambda_P=940\text{nm}$
- Pb Free
- This product itself will remain within RoHS compliant version.

Description

The **EAITRBA1** consist of an infrared emitting diode and an NPN silicon phototransistor, encased side-by-side on converging optical axis in a black thermoplastic housing. The phototransistor receives radiation from the IR only . This is the normal situation. But when an reflecting object close to ITR , phototransistor receives the reflecting radiation .For additional component information, please refer to IR4204-10 and PT4204-6B/H26.

Applications

- Mouse Copier
- Switch Scanner
- Floppy disk driver
- Non-contact Switching
- For Direct Board

Device Selection Guide

Device No.	Chip Material	LENS COLOR
IR	GaAlAs	Blue
PT	Silicon	Black

Absolute Maximum Ratings (Ta=25°C)

Parameter		Symbol	Ratings	Unit
Input	Power Dissipation at(or below) 25°C Free Air Temperature	Pd	75	mW
	Reverse Voltage	V _R	5	V
	Forward Current	I _F	50	mA
	Peak Forward Current (*1) Pulse width ≤100μs, Duty cycle=1%	I _{FP}	1	A
Output	Collector Power Dissipation	P _C	75	mW
	Collector Current	I _C	20	mA
	Collector-Emitter Voltage	B V _{CEO}	30	V
	Emitter-Collector Voltage	B V _{ECO}	5	V
Operating Temperature		T _{opr}	-40~+85	°C
Storage Temperature		T _{stg}	-40~+85	°C
Lead Soldering Temperature (*2) (1/16 inch form body for 5 seconds)		T _{sol}	260	°C

Notes: (*1) $t_w=100 \mu\text{sec.}$, $T=10 \text{ msec.}$ (*2) $t=5 \text{ Sec}$

Electro-Optical Characteristics (Ta=25°C)

Parameter		Symbol	Min.	Typ.	Max.	Unit	Condition
Input	Forward Voltage	V_F	-	1.2	1.5	V	$I_F=20mA$
	Reverse Current	I_R	-	-	10	μA	$V_R=5V$
	Peak Wavelength	λ_P	-	940	-	nm	$I_F=20mA$
	View Angle	2 θ 1/2	-	35	-	Deg	$I_F=20mA$
Output	Dark Current	I_{CEO}	-	-	100	nA	$V_{CE}=5V, E_e=0mW/cm^2$
	C-E Saturation Voltage	$V_{CE(sat)}$	-	-	0.4	V	$I_C=0.04mA, I_F=40mA$
Collector Current(* 3)		$I_{C(ON)}$	200	-	-	μA	$V_{CE}=5V, I_F=20mA$
		$I_{C(OFF)}$	-	-	28	μA	
Response Time	Rise Time	t_R	-	20	-	μs	$V_{CE}=5V, I_C=100\mu A, R_L=100\Omega$
	Fall Time	t_F	-	20	-	μs	

Typical Electrical/Optical/Characteristics Curves for IR

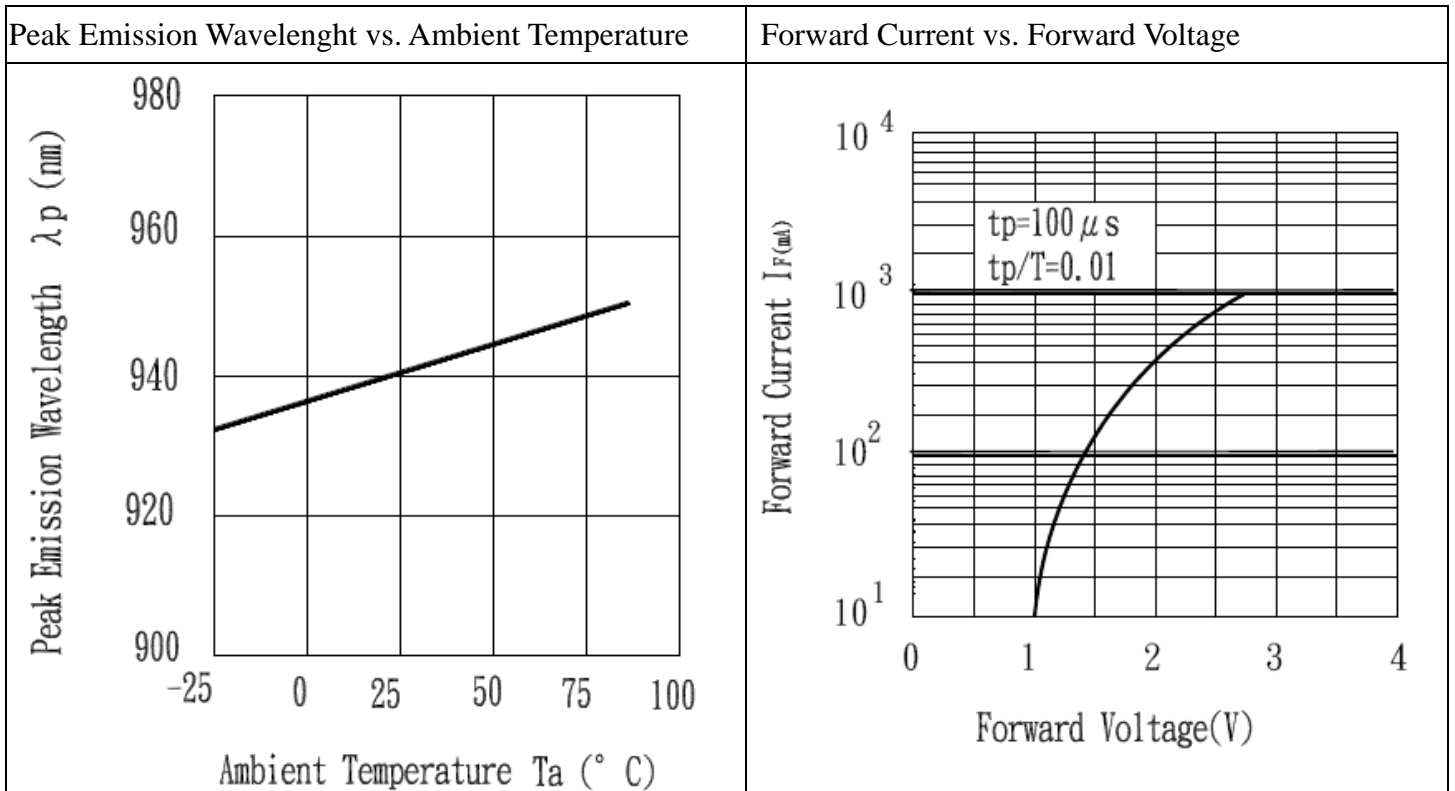
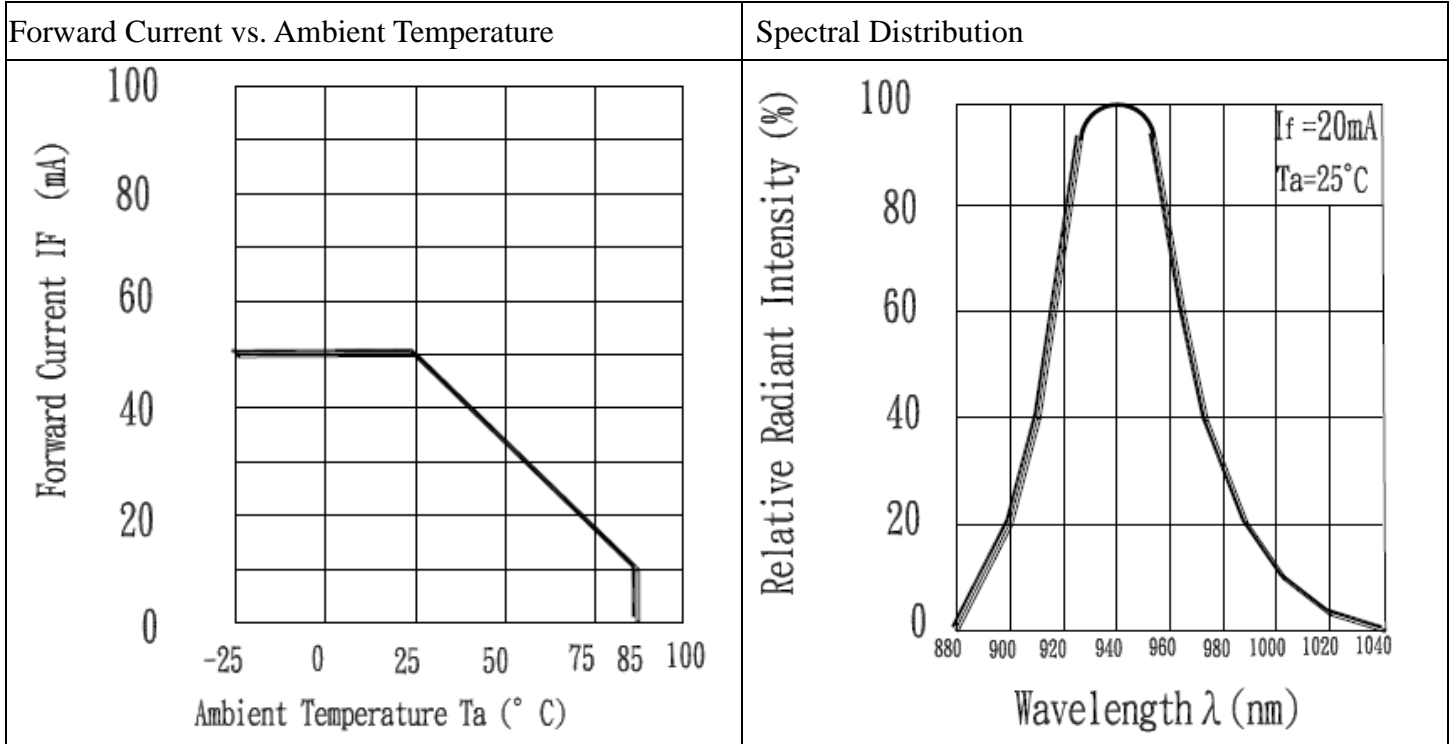

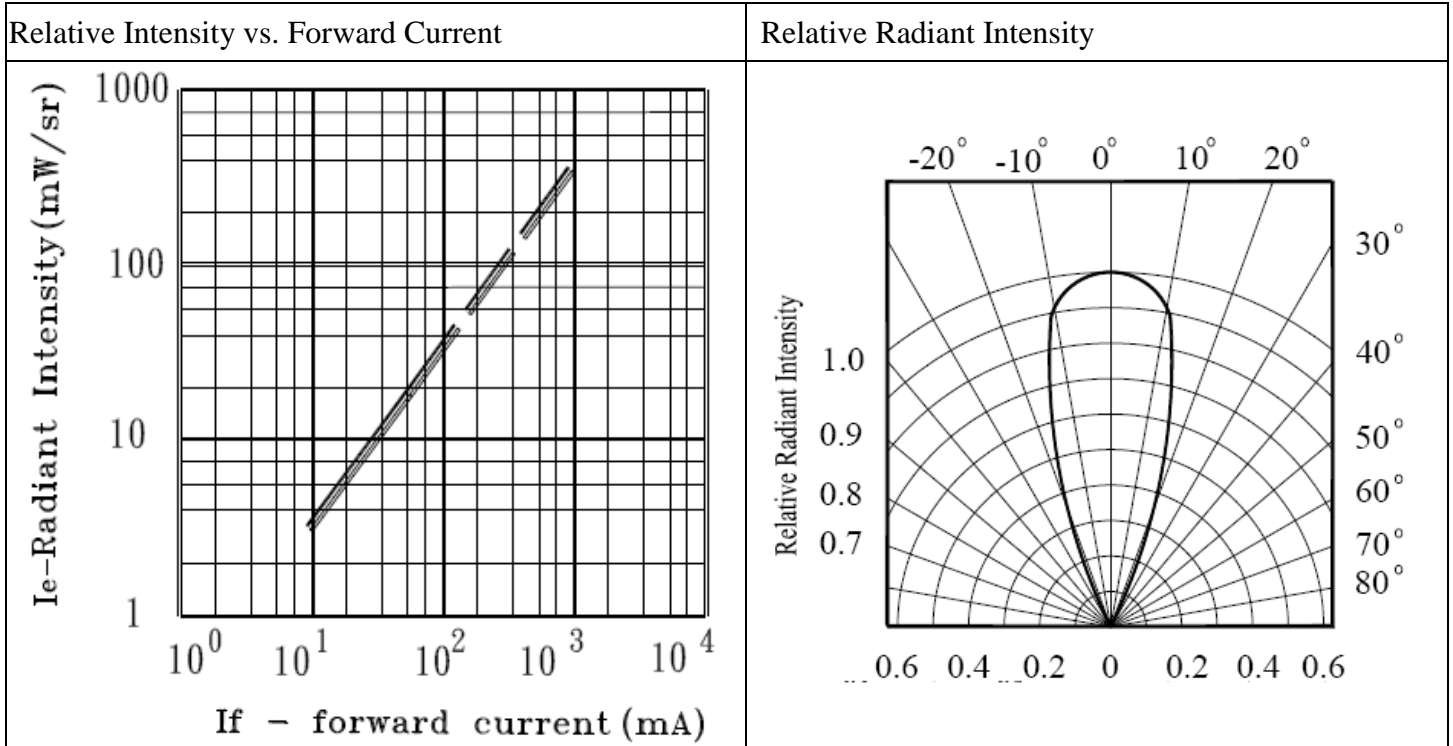

Typical Electro/Optical/Characteristics Curves for PT

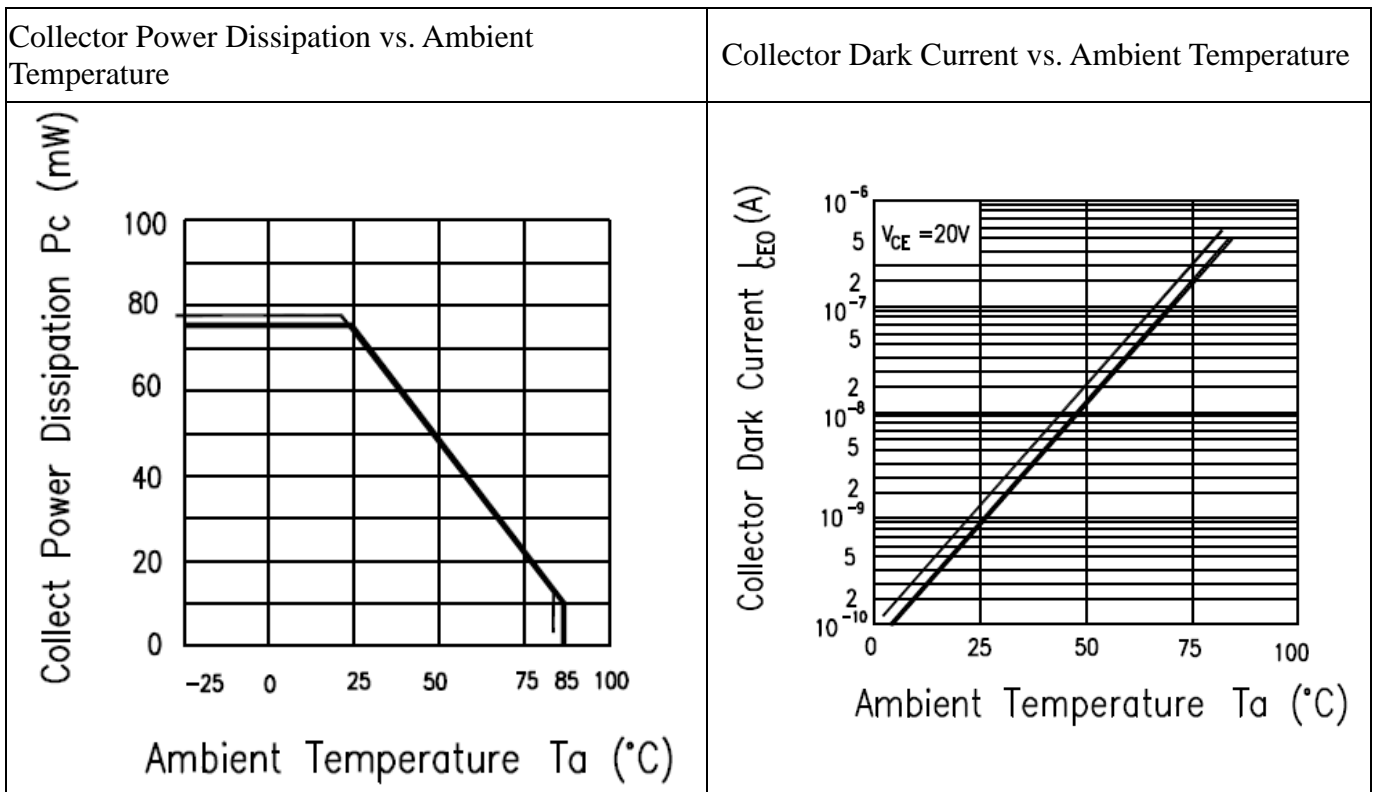

Relative Collector Current vs. Ambient Temperature

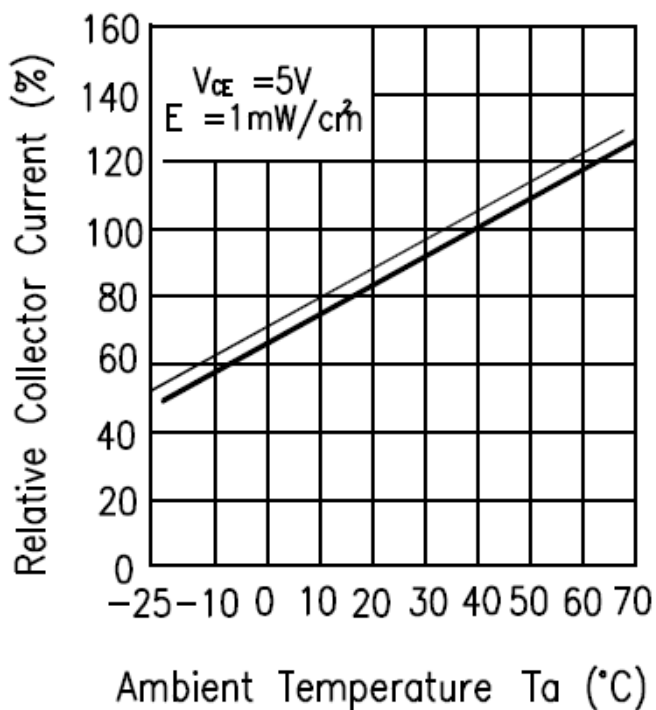

Collector Current vs. Irradiance

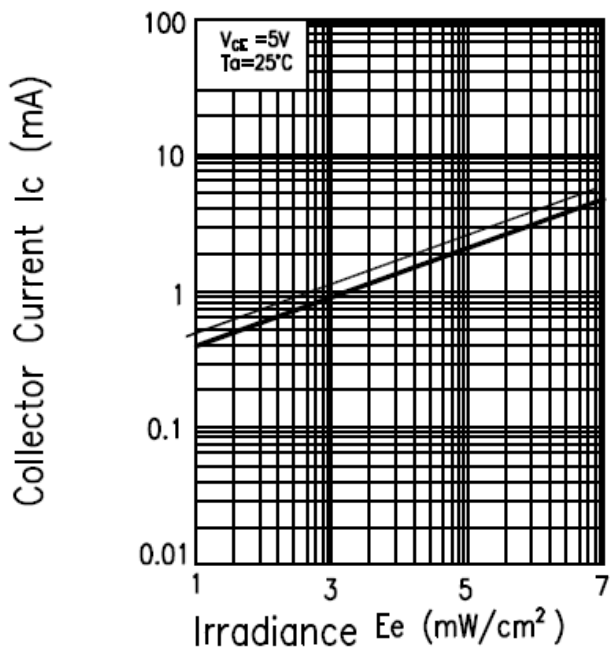

Spectral Sensitivity

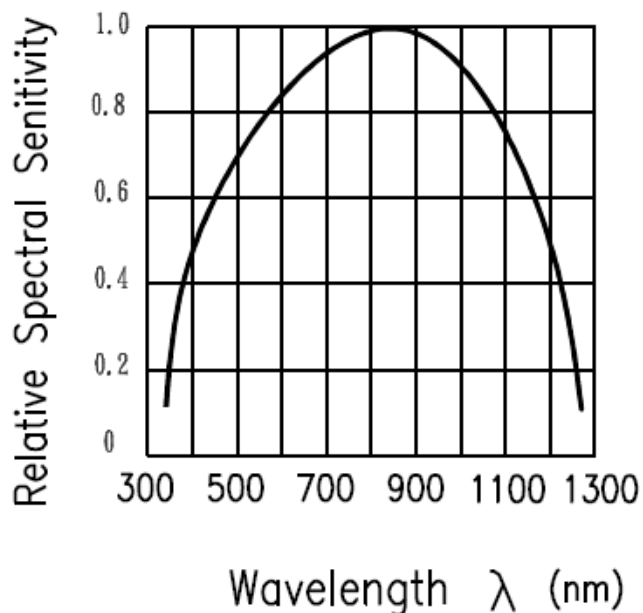

Collector Current vs. Collector-emitter Voltage

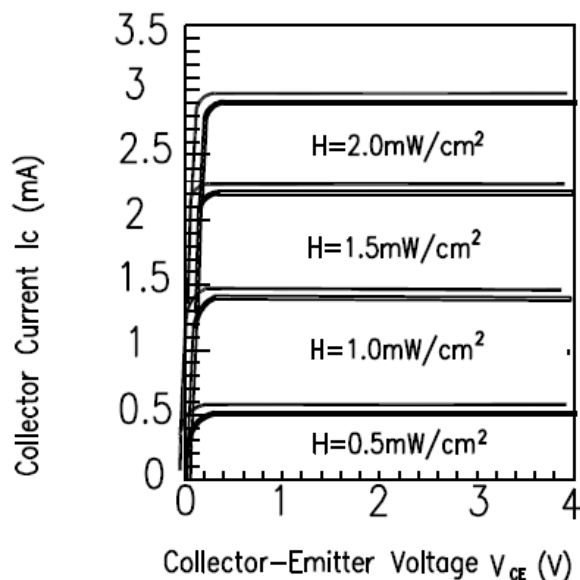

Reliability Test Item And Condition

The reliability of products shall be satisfied with items listed below.

Confidence level : 90%

LTPD : 10%

NO.	Item	Test Condition	Test Hours/ Cycle	Sample Size	Failure Judgement Criteria	Ac/Re
1	Solder Heat	TEMP : 260°C ± 5 °C	10 sec	22 PCs	Ic(on) ≤ L×0.8 L :Lower specification limit	0/1
2	Temperature Cycle	H : +100°C 15 mins ↑ 5 min ↓ L : -40°C 15 min	300 cycle	22 PCs		0/1
3	Thermal Shock	H : +100°C 5 min ↑ 10 sec ↓ L : -10°C 5 min	300 cycle	22 PCs		0/1
4	High Temperature Storage	TEMP. : +100°C	1000 hrs	22 PCs		0/1
5	Low Temperature Storage	TEMP. : -40°C	1000 hrs	22 PCs		0/1
6	DC Operating Life	V _{CE} =5V I _F =20mA	1000 hrs	22 PCs		0/1
7	High Temperature / High Humidity	85°C / 85% R.H.	1000 hrs	22 PCs		0/1

Package Dimension

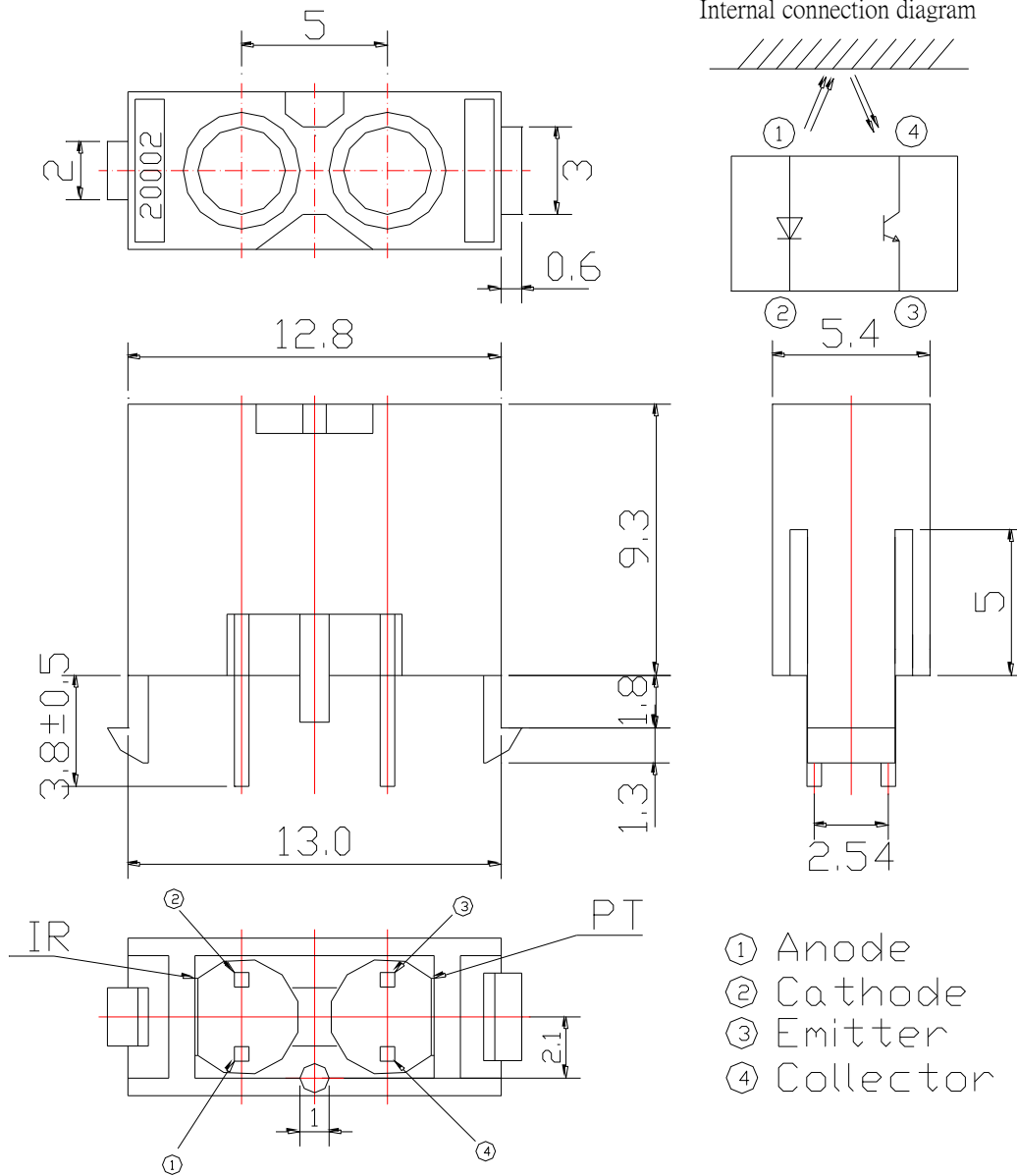

- ① Anode
- ② Cathode
- ③ Emitter
- ④ Collector

Packing Quantity Specification

- 1.150PCS/1Bag, 5Bag/1Box
2. 10Boxes/1Carton

Label Form Specification

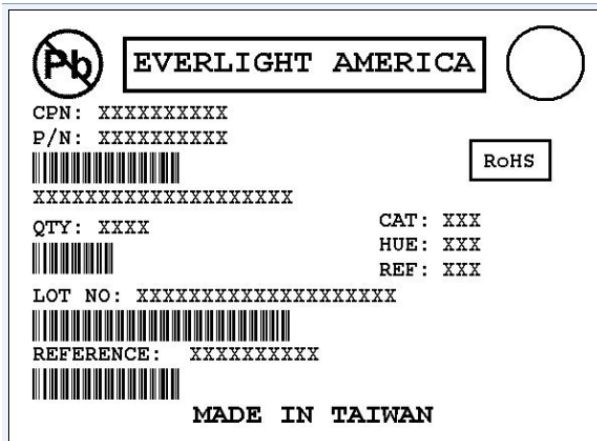

- CPN: Customer's Product Number
- P/N: Product Number
- QTY: Packing Quantity
- CAT: Luminous Intensity Rank
- HUE: Dom. Wavelength Rank
- REF: Forward Voltage Rank
- LOT No: Lot Number
- X: Month
- Reference: Identify Label Number

Notes

1. Above specification may be changed without notice. EVERLIGHT Americas will reserve authority on material change for above specification.
2. When using this product, please observe the absolute maximum ratings and the instructions for using outlined in these specification sheets. EVERLIGHT Americas assumes no responsibility for any damage resulting from use of the product which does not comply with the absolute maximum ratings and the instructions included in these specification sheets.
3. These specification sheets include materials protected under copyright of EVERLIGHT Americas corporation. Please don't reproduce or cause anyone to reproduce them without EVERLIGHT Americas consent.