



User Manual

ASMB-822I

**Intel E5-2600(v2) Series Single
Processor ATX Server Board**

ADVANTECH

Enabling an Intelligent Planet

Copyright

The documentation and the software included with this product are copyrighted 2012 by Advantech Co., Ltd. All rights are reserved. Advantech Co., Ltd. reserves the right to make improvements in the products described in this manual at any time without notice. No part of this manual may be reproduced, copied, translated or transmitted in any form or by any means without the prior written permission of Advantech Co., Ltd. Information provided in this manual is intended to be accurate and reliable. However, Advantech Co., Ltd. assumes no responsibility for its use, nor for any infringements of the rights of third parties, which may result from its use.

Acknowledgements

Intel and Pentium are trademarks of Intel Corporation.

Microsoft Windows and MS-DOS are registered trademarks of Microsoft Corp.

All other product names or trademarks are properties of their respective owners.

Product Warranty (2 years)

Advantech warrants to you, the original purchaser, that each of its products will be free from defects in materials and workmanship for two years from the date of purchase.

This warranty does not apply to any products which have been repaired or altered by persons other than repair personnel authorized by Advantech, or which have been subject to misuse, abuse, accident or improper installation. Advantech assumes no liability under the terms of this warranty as a consequence of such events.

Because of Advantech's high quality-control standards and rigorous testing, most of our customers never need to use our repair service. If an Advantech product is defective, it will be repaired or replaced at no charge during the warranty period. For out-of-warranty repairs, you will be billed according to the cost of replacement materials, service time and freight. Please consult your dealer for more details.

If you think you have a defective product, follow these steps:

1. Collect all the information about the problem encountered. (For example, CPU speed, Advantech products used, other hardware and software used, etc.) Note anything abnormal and list any onscreen messages you get when the problem occurs.
2. Call your dealer and describe the problem. Please have your manual, product, and any helpful information readily available.
3. If your product is diagnosed as defective, obtain an RMA (return merchandise authorization) number from your dealer. This allows us to process your return more quickly.
4. Carefully pack the defective product, a fully-completed Repair and Replacement Order Card and a photocopy proof of purchase date (such as your sales receipt) in a shippable container. A product returned without proof of the purchase date is not eligible for warranty service.
5. Write the RMA number visibly on the outside of the package and ship it prepaid to your dealer.

A Message to the Customer

Advantech Customer Services

Each and every Advantech product is built to the most exacting specifications to ensure reliable performance in the harsh and demanding conditions typical of industrial environments. Whether your new Advantech equipment is destined for the laboratory or the factory floor, you can be assured that your product will provide the reliability and ease of operation for which the name Advantech has come to be known.

Your satisfaction is our primary concern. Here is a guide to Advantech's customer services. To ensure you get the full benefit of our services, please follow the instructions below carefully.

Technical Support

We want you to get the maximum performance from your products. So if you run into technical difficulties, we are here to help. For the most frequently asked questions, you can easily find answers in your product documentation. These answers are normally a lot more detailed than the ones we can give over the phone.

So please consult this manual first. If you still cannot find the answer, gather all the information or questions that apply to your problem, and with the product close at hand, call your dealer. Our dealers are well trained and ready to give you the support you need to get the most from your Advantech products. In fact, most problems reported are minor and are easily solved over the phone.

In addition, free technical support is available from Advantech engineers every business day. We are always ready to give advice on application requirements or specific information on the installation and operation of any of our products.

Declaration of Conformity

FCC

This device complies with the requirements in part 15 of the FCC rules:

Operation is subject to the following two conditions:

- This device may not cause harmful interference
- This device must accept any interference received, including interference that may cause undesired operation.

This equipment has been tested and found to comply with the limits for a Class B digital device, pursuant to Part 15 of the FCC Rules. These limits are designed to provide reasonable protection against harmful interference when the equipment is operated in a commercial environment. This equipment generates, uses, and can radiate radio frequency energy and, if not installed and used in accordance with the instruction manual, may cause harmful interference to radio communications. Operation of this device in a residential area is likely to cause harmful interference in which case the user will be required to correct the interference at his/her own expense. The user is advised that any equipment changes or modifications not expressly approved by the party responsible for compliance would void the compliance to FCC regulations and therefore, the user's authority to operate the equipment.

Caution! *There is a danger of a new battery exploding if it is incorrectly installed. Do not attempt to recharge, force open, or heat the battery. Replace the battery only with the same or equivalent type recommended by the manufacturer. Discard used batteries according to the manufacturer's instructions.*



Peripheral Compatibility

Category	Advantech PN	Vendor	Part Description	Remarks
MB	ASMB-822I-00A1E	Advantech	Support BMC module	
	ASMB-822-00A1E	Advantech	Basic sku	
CPU	96MPXE-2.1-20M20T	Intel	Xeon E5-2658/2.1GHz/8cores	95W
	96MPXE-2.0-15M20T	Intel	Xeon E5-2620/2.0GHz/6cores	95W
	96MPXE-1.8-20M20T	Intel	Xeon E5-2648L/1.8GHz/8cores	70W
SATA3 HDD	96HD500G-ST-SG7K12	SEAGATE	500G 3.5" SATA 7KRPM 16M	ST500DM002
	96HD1000G-ST-SG7K6	SEAGATE	1T 3.5" SATA 7KRPM 64M	ST1000DM003
	96HD2000G-ST-SG7K2	SEAGATE	2T 3.5" SATA 7KRPM 64M	ST2000DM001
Memory / REG	96D3-1G1333ER-AP	Apacer	1G DDR3-1333 240PIN REG 128X8 ELP(G)	78.01GCC.AF0
	96D3-2G1333ER-AP	Apacer	2G DDR3-1333 240PIN REG 128X8 ELP(G)	78.A1GDR.4200C
	96D3-4G1333ER-AP1	Apacer	4G DDR3-1333 240PIN REG 256X8 HYX(G)	78.B1GDR.4201C
	TBD	Transcend	1G DDR3-1333 240PIN ECC REG	TS128MKR72V3U
	TBD	Transcend	2G DDR3-1333 240PIN ECC REG	TS256MKR72V3U
	TBD	Transcend	4G DDR3-1333 240PIN ECC REG	TS512MKR72V3N
	TBD	ADATA	4G DDR3-1333 240PIN ECC REG	EL931C18
	TBD	Transcend	16G DDR3-1600 240PIN ECC REG	TS2GKR72V6Z
	TBD	ADATA	8G DDR3-1333 240PIN ECC REG	EL931D18
	TBD	InnoDisk	4G DDR3-1333 240PIN ECC REG	ACT4GHR72P8H1333H
	TBD	InnoDisk	8G DDR3-1333 240PIN ECC REG	ACT8GHR72Q4H1333S
	TBD	InnoDisk	16G DDR3-1066 240PIN ECC REG	ACT16GHR72Q4J1333S
	Memory / ECC	TBD	Transcend	1G DDR3-1333 240PIN ECC
TBD		Transcend	2G DDR3-1333 240PIN ECC	TS256MLK72V3U
TBD		Transcend	4G DDR3-1333 240PIN ECC	TS512MLK72V3N
TBD		InnoDisk	4G DDR3-1333 240PIN ECC	M3CN-4GHJ3C09
TBD		ADATA	4G DDR3-1333 240PIN ECC	EL031C18
Memory / UNB	TBD	ADATA	4G DDR3-1600 240PIN	EL64C1C16
	96D3-4G1333NN-TR	Transcend	4G DDR3-1333 240PIN	TS512MLK64V3N
Cooler	1960058073N001	CoolJag	Cooler I-LGA2011 S-95W 102×71.2×62-SS 12V4B	VGC6R01A-1-000
Option Card	PCA-AUDIO-HDA1E	Advantech	Audio card	
Riser Card	ASMB-RF348-21A1E	Advantech	ASMB-RF348 (2U riser card)	2*PCIe x4 + 1*PCIe x8
	ASMB-RF3X8-21A1E	Advantech	ASMB-RF3X8 (2U riser card)	1*PCIex4 + 2*PCI-X

Initial Inspection

Before installing motherboard, please make sure that the following materials have been shipped:

- 1 x ASMB-822I ATX motherboard
- 1 x ASMB-822I Startup Manual
- 1 x Driver CD (user manual is included)
- 2 x Serial ATA HDD data cables
- 1 x I/O port bracket
- 2 x SATA power cable
- 1 x Warranty card

If any of these items are missing or damaged, contact distributor or sales representative immediately. We have carefully inspected the ASMB-822I mechanically and electrically before shipment. It should be free of marks and scratches and in perfect working order upon receipt. When unpacking the ASMB-822I, check it for signs of shipping damage. (For example, damaged box, scratches, dents, etc.) If it is damaged or it fails to meet the specifications, notify our service department or local sales representative immediately. Also notify the carrier. Retain the shipping carton and packing material for inspection by the carrier. After inspection, we will make arrangements to repair or replace the unit.

Order Information

Part Number	HDD	Expansion Slot	IPMI
ASMB-822I-00A1E	2*SATA3 + 4* SATA2	5*PCIe x8 + 1* PCIe x4 + 1* PCI	Yes
ASMB-822-00A1E	2*SATA3 + 4* SATA2	5*PCIe x8 + 1* PCIe x4 + 1* PCI	-

Contents

Chapter 1	Overview	1
1.1	Introduction	2
1.2	Features	2
1.3	Specifications	3
	Table 1.1: Specifications	3
1.4	Board Layout, Jumpers and Connectors.....	5
	Figure 1.1 Board Layout	5
	Figure 1.2 Rear I/O	6
	Table 1.2: Onboard LAN LED Color Definition	6
	Table 1.3: Jumpers.....	6
	Table 1.4: Connectors	7
	Table 1.5: Onboard LED.....	8
1.5	Block Diagram.....	8
	Figure 1.3 Block Diagram	8
1.6	System Memory	9
1.7	Memory Installation Procedures.....	9
1.8	Processor Installation.....	11
Chapter 2	Connections	15
2.1	Introduction	16
2.2	USB Ports and LAN Ports (USB0~USB11/LAN1/LAN2/IPMI_LAN1)	16
2.3	VGA Connector	17
2.4	Serial Ports (COM1/COM2)	17
2.5	PS2 Keyboard and Mouse Connectors (KBMS1/KBMS2)	18
2.6	CPU Fan Connector (CPU FAN0).....	18
	Table 2.1: CPU FAN0 Pin Definition.....	18
2.7	System Fan Connector (SYS FAN0/FAN1)	19
	Table 2.2: SYS FAN0 Pin Definition	19
2.8	Front Panel Connector (JFP1)	19
	2.8.1 Power LED (JFP1).....	20
	Table 2.3: ATX Power Supply LED Status	20
	2.8.2 External Speaker (JFP1 pins 10, 12, 14, 16).....	20
	2.8.3 HDD LED Connector (JFP1 Pins 5 & 7)	20
	2.8.4 Reset Connector (JFP1 Pins 2 & 4).....	20
	2.8.5 Case Open (JFP1 Pins 6 & 8).....	20
2.9	SATA SGPIO (SATA_SGPIO1)	21
2.10	Front Panel LAN Indicator Connector (LANLED1).....	21
2.11	Serial ATA Interface (SATA0 ~ 5)	22
2.12	PCIe & PCI Expansion Slots	22
2.13	Auxiliary Power Connector (ATX24P_P1/ATX8P_P1).....	23
2.14	HD Audio Interface Connector (AUDIO1)	24
2.15	LPC Connector (LPC1) for Optional TPM Module	24
2.16	Clear CMOS Connector (JCMOS1)	25
2.17	PMBUS Connector (PMBUS1).....	25
2.18	Front Panel SMBUS Connector (SMBUS1).....	26
2.19	IPMI Module Connector (IPMI1).....	26
2.20	VOLT1 Connector	28
2.21	GPIO Connector.....	29
2.22	SNMP Connector	29
Chapter 3	AMI BIOS	31

3.1	Introduction	32
3.2	BIOS Setup	33
3.2.1	Main Menu	33
3.2.2	Advanced BIOS Features Setup	33
3.2.3	Chipset	51
3.2.4	Server Management	57
3.2.5	Boot	59
3.2.6	Security	60
3.2.7	Save & Exit	60
Chapter 4	Chipset Software Installation Utility	63
4.1	Before Beginning	64
4.2	Introduction	64
4.2.1	Main Menu	64
4.3	Windows XP / Windows 2003 / Windows 2008 / Windows 7 Driver Setup	65
Chapter 5	VGA Setup	67
5.1	Introduction	68
5.2	Windows Series Driver Setup	68
Chapter 6	LAN Configuration & USB 3.0	69
6.1	LAN Configuration	70
6.1.1	Introduction	70
6.1.2	Features	70
6.1.3	Installation	70
6.1.4	Windows Series Driver Setup (LAN)	70
6.2	USB 3.0	71
6.2.1	Introduction	71
6.2.2	Windows series driver setup	71
Appendix A	Programming the Watchdog Timer .	73
A.1	Watchdog Timer Overview	74
A.2	Programming the Watchdog Timer	74
	Table A.1: Watchdog Timer Registers	76
A.2.1	Example Programs	76
Appendix B	I/O Pin Assignments	81
B.1	USB Header (USB45, USB67, USB89)	82
	Table B.1: USB Header (USB45,USB67,USB89,USB1011)	82
B.2	VGA Connector (VGA1)	82
	Table B.2: VGA Connector (VGA1)	82
B.3	RS-232 Interface (COM2)	83
	Table B.3: RS-232 Interface (COM2)	83
B.4	PS/2 Keyboard and Mouse Connector (KBMS1)	83
	Table B.4: Keyboard and Mouse Connector (KBMS1)	83
B.5	External Keyboard Connector (KBMS2)	84
	Table B.5: External Keyboard Connector (KBMS2)	84
B.6	System Fan Power Connector (SYSFAN0~2)	84
	Table B.6: Fan Power Connector (SYSFAN0/SYSFAN1/ SYSFAN2)	84

B.7	Power LED (JFP1)	84
	Table B.7: Power LED (JFP1).....	84
B.8	External Speaker Connector (JFP1)	85
	Table B.8: External Speaker Connector (JFP1).....	85
B.9	Reset Connector (JFP1)	85
	Table B.9: Reset Connector (JFP1).....	85
B.10	HDD LED Connector (JFP1).....	85
	Table B.10:HDD LED Connector (JFP1)	85
B.11	ATX Soft Power Switch (JFP1)	86
	Table B.11:ATX Soft Power Switch (JFP1).....	86
B.12	Front panel SMBus Connector (SMBUS1).....	86
B.13	USB/LAN Ports (LAN1_USB01 and LAN2_USB23)	86
	Table B.12:USB Port.....	86
	Table B.13:Giga LAN 10/100/1000 Base-T RJ-45 Port	87
B.14	Audio Connector (AUDIO1).....	87
	Table B.14:Front Panel Audio Connector (FPAUD1).....	87
B.15	8-pin Alarm Board Connector (VOLT1).....	87
	Table B.15:8-pin Alarm Board Connector (VOLT1)	87
B.16	Case Open Connector (JFP1).....	88
	Table B.16:Case Open Connector (JFP1).....	88
B.17	Front Panel LAN LED Connector (LANLED1).....	88
	Table B.17:LAN LED Connector (LANLED1).....	88

Chapter 1

Overview

1.1 Introduction

The ASMB-822I serverboard is the most advanced Intel Xeon E5-2600 (V2) series board for server-grade IPC applications that require high-performance computing power & multi-expansion slots. This serverboard supports Intel Xeon E5-2600(v2) series processor and DDR3 1066/1333/1600 MHz memory up to 96 GB.

ASMB-822I provides 5 x PCIe x16 slot (x8 link) & 1 x PCIe x8 slot (x4 link) & 1 x PCI slot which can support up to five high performance graphic cards and still keep 1 PCI slot on board for legacy PCI device use.

In addition, the ASMB-822I has dual Gigabit Ethernet LAN ports via a dedicated PCIe x1 bus, which offer bandwidth up to 500 MB/s, eliminating network bottlenecks.

The ASMB-822I has a third RJ-45 LAN connector which is dedicated for IPMI function allowing remote control

High reliability and outstanding performance makes ASMB-822I the ideal platform for industrial server/networking applications.

By using the Intel C602J chipset, the ASMB-822I offers a variety of features such as 4 onboard SATA II, and 2 onboard SATA III interfaces; it supports IRST (Intel Rapid Storage Technology) and provides RAID 0, 1, 10 and 5 (Windows only*); and it has 12 x USB 2.0 & 2 x USB 3.0 connectors.

These powerful I/O capabilities ensure even more reliable data storage capabilities and high-speed I/O peripheral connectivity.

Note!



1. *IPMI module will be included in ASMB-822I sku.*
2. *6 rear USB connectors(2*USB3.0 & 4*USB2.0); 3 USB pin headers onboard (2 ports from one header); 2 type-A USB connector onboard.*
3. *Please refer to the release note of each Linux OS for Intel's C602J chipset SATA RAID function support.*

1.2 Features

General

- **Intel E5-2600(v2) processor support:** ASMB-822I supports one Intel E5-2600(v2) series Quad/Six/Eight/Ten core processors.
- **High performance I/O capability:** Dual Gigabit LAN, five PCIe x16 (x8 link) slots, 6 SATA connectors and 12 USB 2.0 ports.
- **Standard ATX form factor with industrial features:** ASMB-822I provides industrial features like long product lifecycle, reliable operation under wide temperature range, watchdog timer, etc.
- **IPMI 2.0 support:** ASMB-822I equipped with Aspeed 2300 BMC chip supports IPMI 2.0 (Intelligent Platform Management Interface 2.0) via dedicated LAN port.
- **KVM over IP:** ASMB-822I KVM over IP function allows remote control of system through your own computer.

1.3 Specifications

Table 1.1: Specifications

Processor	
CPU	<ul style="list-style-type: none"> ■ Single Intel LGA2011 XEON processor sockets ■ Supports Intel XEON E5-2600(v2) series processor with Quad/Six/E5-2600/E5-2600 V2 cores ■ Supports the TDP of processor up to 95 W
System Memory	
Memory Capacity	<ul style="list-style-type: none"> ■ Xeon processor supports DDR3 memory bus ■ Total 6 memory slots provided ■ Supports up to 96 GB memory
Memory Type	Supports DDR3 1066/1333/1600 MHz ECC Registered / ECC Unbuffered / Non-ECC Unbuffered Modules.
DIMM Sizes	Each memory slot supports 1GB, 2GB, 4GB, 8GB and 16GB memory modules
Memory Voltage	1.35V & 1.5 V
Error Detection	<ul style="list-style-type: none"> ■ Corrects single-bit errors ■ Detects double-bit errors (using ECC memory)
On-Board Devices	
Chipsets	Intel C602J PCH provide 8xPCIe Gen2 lanes
Network Controllers	<ul style="list-style-type: none"> ■ 1 x Intel I210 Gigabit Ethernet Controller connected to C602J through PCIe Gen2 Lane. ■ 1x Intel 82579LM Gigabit PHY connected to C602J MAC. ■ Above network Supports 10BASE-T, 100BASE-TX, and 1000BASE-T, RJ-45 output.
VGA	ASPEED AST2300/1300 controller with 64 MB VGA memory provides basic 2D VGA function.
Super I/O	Nuvoton NCT6776F chip provide motherboard keyboard mouse, RS-232, parallel port and hardware monitor functions.
BMC (822I SKU Only)	1 x 10/100BASE RealTek 8201EL-VB PHY connected to AST2300 for dedicated IPMI/IKVM.
Input / Output	
Serial ATA	<ul style="list-style-type: none"> ■ Total 6 x SATA ports, 2 ports provide 6 Gb/s bandwidth, 4 ports provide 3 Gb/s bandwidth. ■ RAID 0, 1, 5, 10 support (Windows only, for Linux support please refer to the note item 3 of chapter 1.1).
LAN	<ul style="list-style-type: none"> ■ 2 x RJ-45 LAN ports (10/100/1000 Base-T LAN). ■ 1 x RJ-45 Dedicated IPMI LAN port(10/100 Base-T) for IPMI only, there is no regular LAN function (ASMB-822I SKU Only).
USB	<ul style="list-style-type: none"> ■ 2 x USB3.0 + 4 x USB 2.0 ports at rear window. ■ 3 x USB internal headers (6 ports). ■ 2 x internal Type-A USB port.
VGA	■ 1 x VGA port.
Keyboard / Mouse	■ PS/2 keyboard and mouse connector at rear window.
Serial Port / Header	<ul style="list-style-type: none"> ■ 1 x internal header (2 x 5 2.5 mm pitch) for UART port. ■ 1 x external DB9 UART at rear window.
Parallel Port / Header	■ 1 x internal header.
Power Connector	

Table 1.1: Specifications

System Power	1 x 24-pin SSI EPS 12 V power connector (Input 12 V, 5 V, 3.3 V, 5 V standby)
CPU Power	1 x 8 pin SSI EPS 12 V power connector for CPU & Memory power (12V)
Expansion Slots	
PCIexpress	<ul style="list-style-type: none">■ 5 x PCIe x16 slot (Gen3 x8 Link)■ 1 x PCIe x8 slot (Gen2 x4 link)■ 1 x PCI
System BIOS	
BIOS Type	64 Mb SPI Flash EEPROM with AMI BIOS
PC Health Monitoring	
Voltage	Monitors for CPU Cores, +3.3 V, +5 V, +12 V, +5 V Standby, VBAT
FAN	<ul style="list-style-type: none">■ One 4-pin heads for CPU cooler and four 4-pin headers for system fan.■ All fans with tachometer status monitoring■ Thermal control for all fan connectors
Temperature	<ul style="list-style-type: none">■ Monitoring for CPU (PECI)■ Monitoring for System (SIO)
Other Features (Case Open)	<ul style="list-style-type: none">■ Chassis intrusion detection■ Chassis Intrusion header
Operating Environment / Compliance	
RoHS	RoHS Compliant 6/6 Pb Free
Environmental Spec.	<ul style="list-style-type: none">■ Operating Temperature: 0 to 60°C■ Non-operating Temperature: -10 to 70°C■ Operating Relative Humidity: 0% to 90% (non-condensing)■ Non-operating Relative Humidity: 5% to 95% (non-condensing)

1.4 Board Layout, Jumpers and Connectors

Connectors on the ASMB-822I are linked to external devices such as hard disk drives. In addition, ASMB-822I has a number of jumpers that are used to configure system for specific applications.

The tables below list the functions of each jumper and connector. Later sections in this chapter give instructions for setting jumpers. Chapter 2 gives instructions for connecting external devices to ASMB-822I.

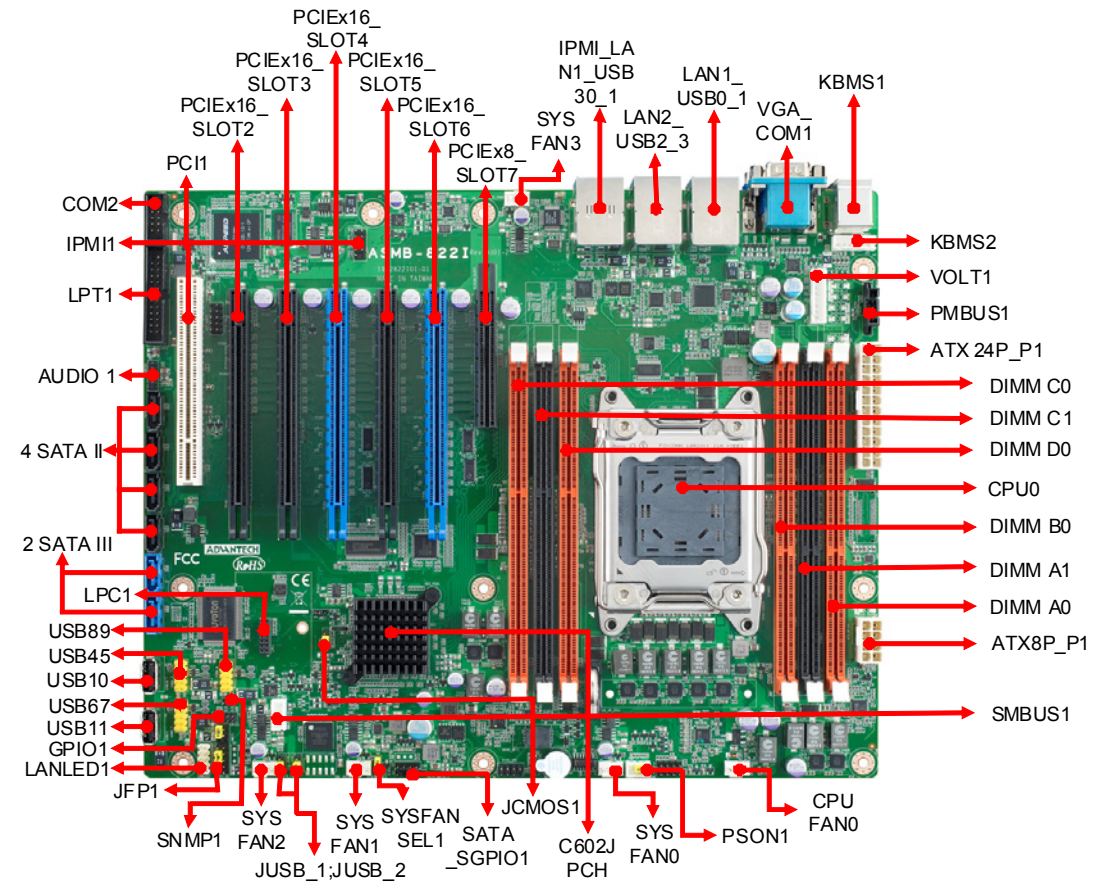

Figure 1.1 Board Layout

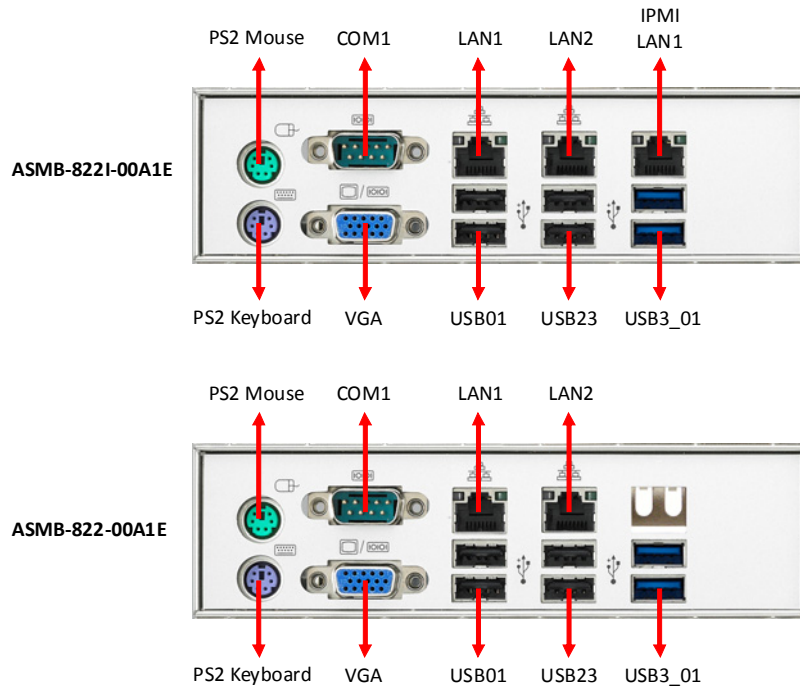

Figure 1.2 Rear I/O

Table 1.2: Onboard LAN LED Color Definition

10/100/1000 Mbps LAN Link/Activity LED Scheme

		LAN1 & LAN2		IPMI LAN1	
		Left LED	Right LED	Left LED	Right LED
10 Mbps	Link Active	Off	Green Blinking green	Amber	- Blinking green
100 Mbps	Link Active	Amber	Green Blinking green	Amber	- Blinking green
1000 Mbps	Link Active	Green	Green Blinking green	-	-
No Link		Off	Off	Off	Off

Table 1.3: Jumpers

Label	Function	Default
JCMOS1	CMOS Clear	1-2
JME1	ME update	1-2
SYSFAN_SEL1	PWM/DC mode for system fan	1-2
PSON1	ATX/AT mode for system	2-3
JUSB_1	Rear USB port 5V from standby power or normal power	1-2
JUSB_2	Onboard/front USB port 5V from standby power or normal power	1-2

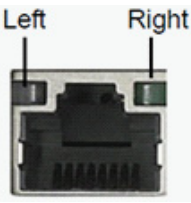
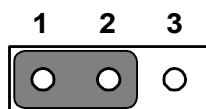

Keep CMOS data/
Disable ME update/
PWM mode for SYS FAN/
AT mode/

Rear USB port 5V from standby power/
Onboard/front USB port 5V from standby power

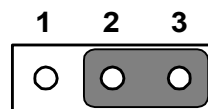

Clear CMOS data/
Enable ME update/
DC mode for SYS FAN/
ATX mode/

Rear USB port 5V from normal power/
Onboard/front USB port 5V from normal power

Table 1.4: Connectors

Label	Function
ATX_8P_P0	SSI EPS 12 V auxiliary power connector (for CPU0) and memory
ATX_24P_P1	SSI EPS 24-pin main power connector (for system)
COM2	Serial port: RS-232
CPU0	Intel LGA2011 CPU0 socket
CPUFAN0	CPU0 fan connector (4-pin)
DIMMA0	Channel A DIMM0 of CPU0
DIMMA1	Channel A DIMM1 of CPU0
DIMMB0	Channel B DIMM0 of CPU0
DIMMC0	Channel C DIMM0 of CPU0
DIMMC1	Channel C DIMM1 of CPU0
DIMMD0	Channel D DIMM0 of CPU0
JFP1	Front panel pin header connector
AUDIO1	HD audio Interface connector
IPMI1	IPMI connector
LANLED1	LAN1/2 LED extension connector
LPC1	LPC port for debug & TPM module
PCIEX8_SLOT7	PCIe x8 slot (x4 link)
PCIEX16_SLOT6	PCIe x16 slot (x8 or x16 link)
PCIEX16_SLOT5	PCIe x16 slot (x8 link)
PCIEX16_SLOT4	PCIe x16 slot (x8 or x16 link)
PCIEX16_SLOT3	PCIe x16 slot (x8 link)
PCIEX16_SLOT2	PCIe x16 slot (x8 link)
PCI1	PCI slot
SATA0	Serial ATA0 hard drive connector (SATA III)
SATA1	Serial ATA1 hard drive connector (SATA III)
SATA2	Serial ATA2 hard drive connector (SATA II)
SATA3	Serial ATA3 hard drive connector (SATA II)
SATA4	Serial ATA4 hard drive connector (SATA II)
SATA5	Serial ATA5 hard drive connector (SATA II)
SYS FAN0	System fan connector (4-pin)
SYS FAN1	System fan connector (4-pin)
SYS FAN2	System fan connector (4-pin)
SYS FAN3	System fan connector (4 pin)
USB45	USB port 4, 5
USB67	USB port 6, 7

Table 1.4: Connectors

USB89	USB port 8, 9
USB1011	USB port 10, 11 (Type-A)
VOLT1	For Advantech alarm board usage
PMBUS1	Power supply SMBbus I2C Header
SATA_SGPIO_1	Support Serial_Link interface for onboard SATA connections
GPIO1	GPIO function for customize usage
SMBUS1	For Advantech chassis usage
KBMS2	For additional keyboard/mouse
SNMP1	For Advantech chassis usage

Table 1.5: Onboard LED

LED	Description	LED Definition	
5V_LED1	Power on LED	Off: Power off	On (Green): System is On
5VSB_LED1	Standby LED	Off: No input AC Power	On (Green): System is ON, in sleep mode, or in soft-off mode
LED1	BMC heartbeat LED (ASMB-822I SKU Only)	Blinking (Green) : Controller is working normally	

1.5 Block Diagram

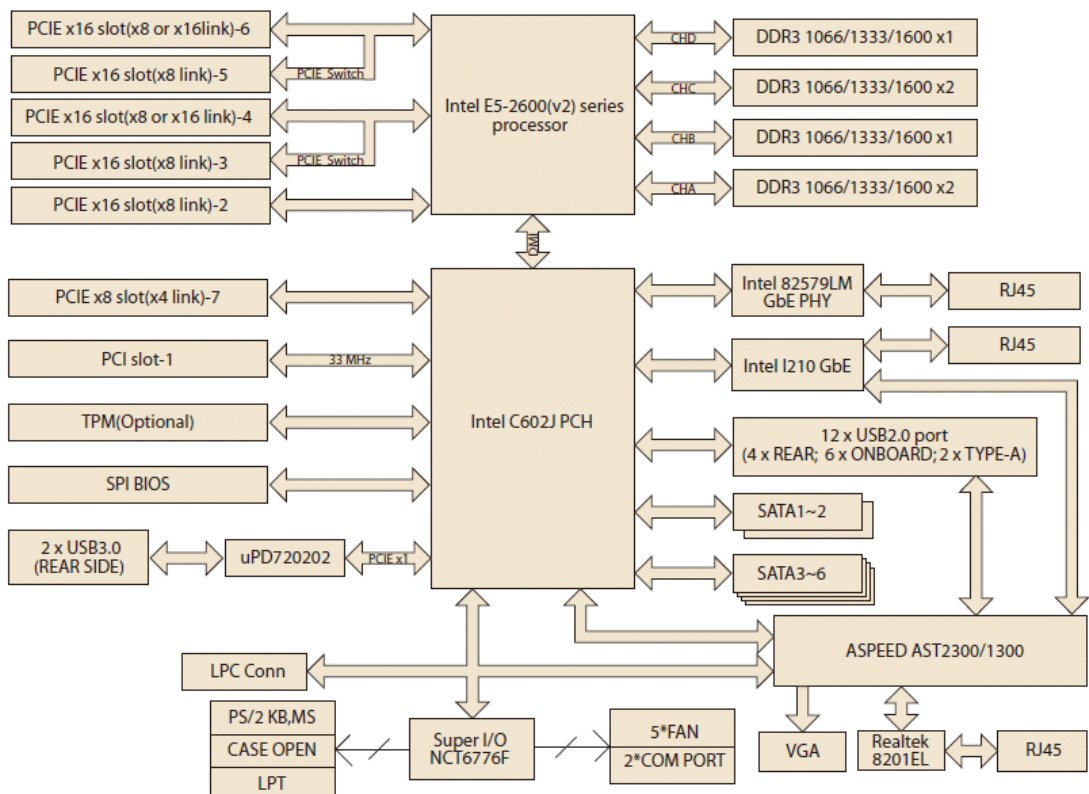

Figure 1.3 Block Diagram

1.6 System Memory

ASMB-822I has six 240-pin memory slots for DDR3 1066/1333/1600 MHz memory modules with maximum capacity of 96 GB (Maximum 16 GB for each DIMM).

ASMB-822I supports registered DIMMs or unbuffered DIMM with ECC / Non-ECC memory module.

1.7 Memory Installation Procedures

Socket / Color	Quantity of memory installed			
	1	2	4	6
DIMM A-0 (Orange)	V	V	V	V
AIMM A-1 (Black)				V
DIMM B-0 (Orange)		V	V	V
DIMM C-0(Orange)			V	V
DIMM C-1 (Black)				V
DIMM D-0 (Orange)			V	V

Step 1

To install DIMMs, first make sure the two handles of the DIMM socket are in the “open” position. i.e. The handles lean outward.

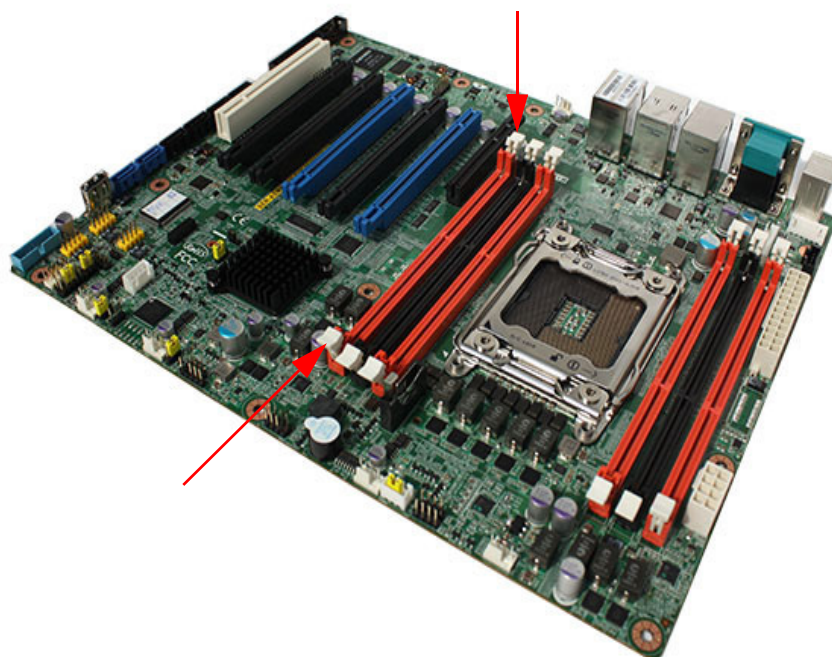

Step 2

Slowly slide the DIMM module along the plastic guides on both ends of the socket,

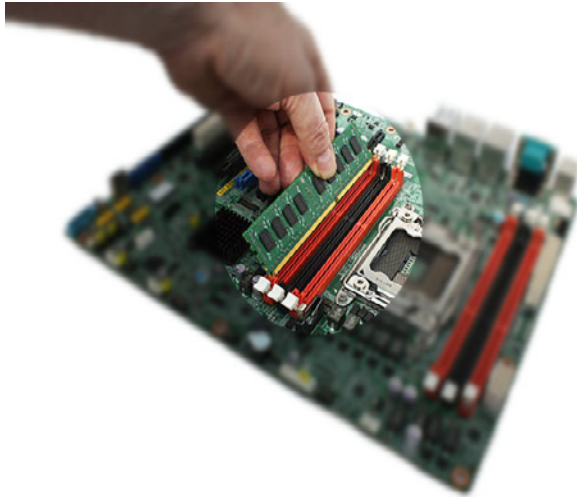

Step 3

Press the DIMM module right down into the socket, until you hear a click. This is when the two handles have automatically locked the memory module into the correct position of the DIMM socket.

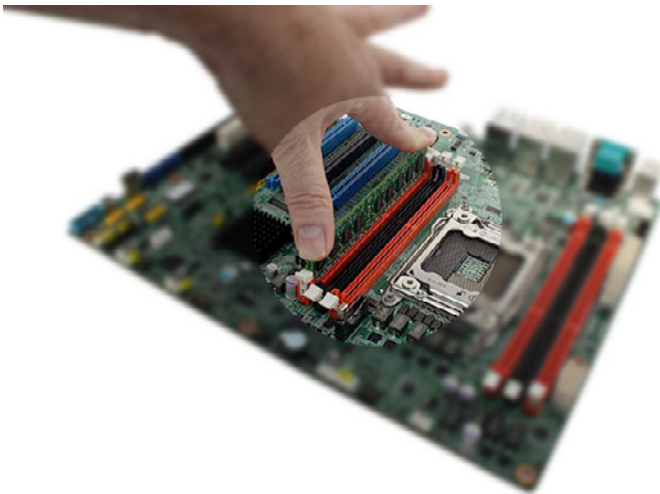

Step 4

Finished.

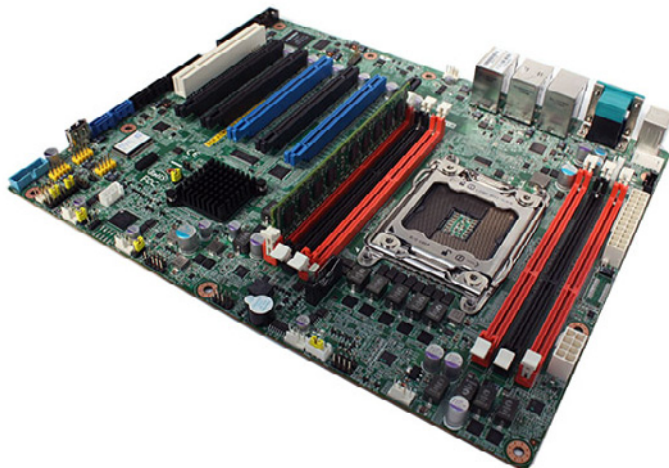

1.8 Processor Installation

The ASMB-822I is designed for single LGA2011, Intel E5-2600 series Xeon processor.

Step 1

Press the first lever and move it sideways slightly until it is released from the retention tab.

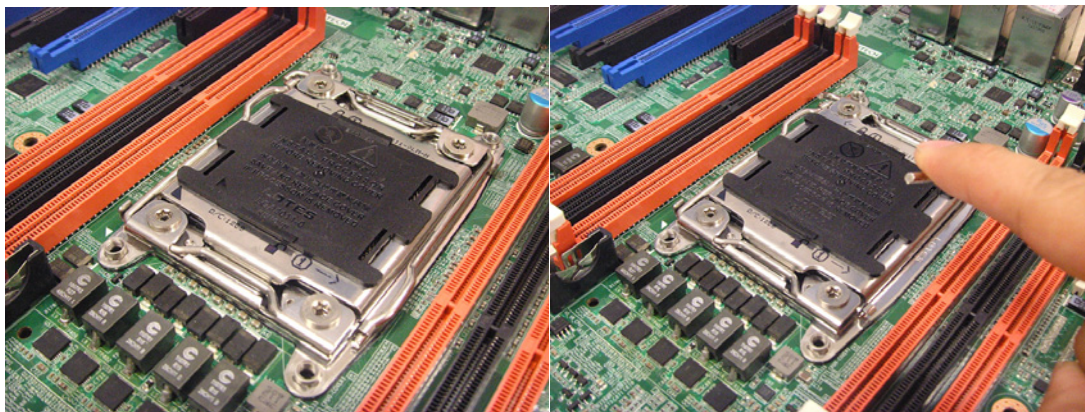

Step 2

Press the other lever and move it sideways slightly until it is also released from the retention tab.

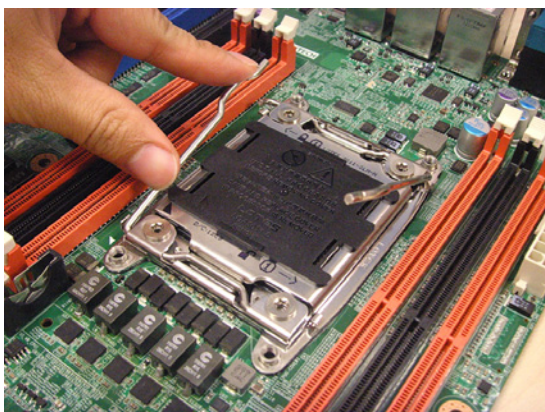

Step 3

Lift the load plate.

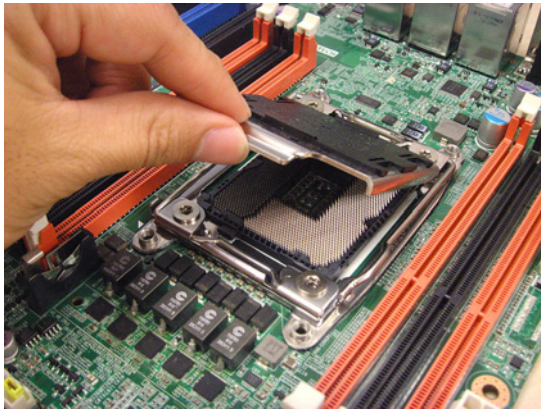

Step 4

Position the CPU over the socket ensuring that the triangle mark on the CPU lines up with the triangle mark on the motherboard.

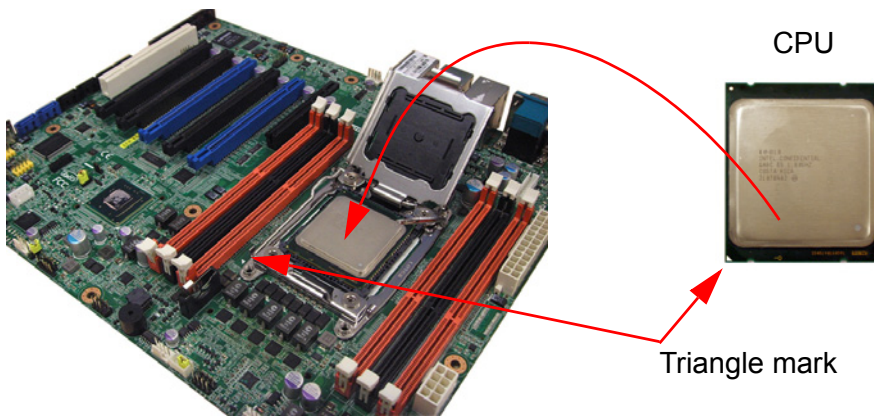

Step 5

Remove protective plastic cover.

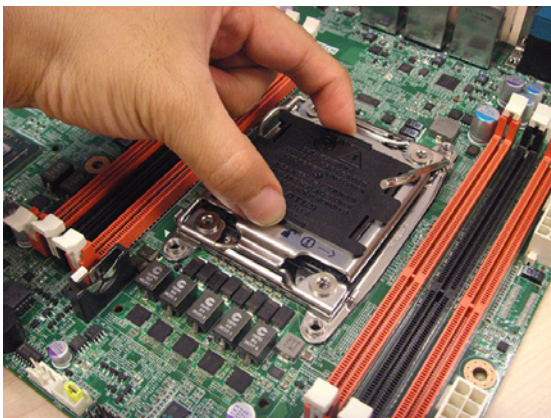

Step 6

Close the load plate over the CPU.

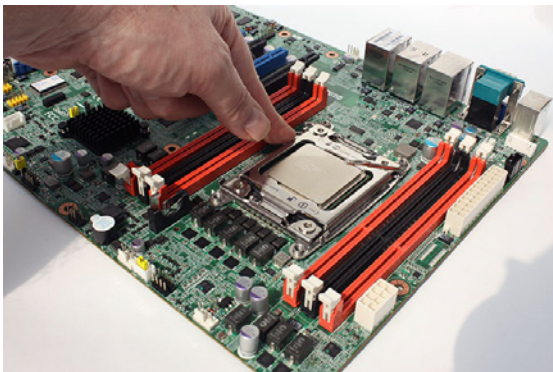
**Step 7**

Push down both levers and insert them under the retention tabs ensuring the edge of the load plate is fixed securely by both levers.

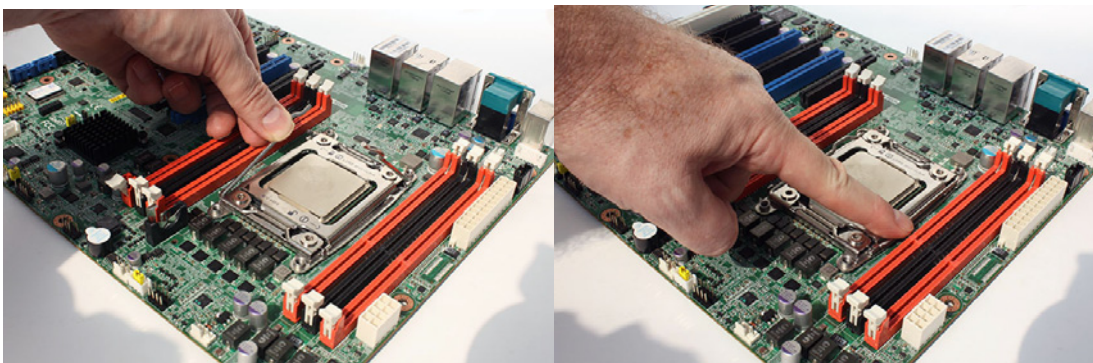
**Step 8**

Finished.



Chapter 2

Connections

2.1 Introduction

You can access most of the connectors from the top of the board as it is being installed in the chassis. If you have a number of cards installed, you may need to partially remove a card to make all the connections.

2.2 USB Ports and LAN Ports (USB0~USB11/LAN1/LAN2/IPMI_LAN1)

The USB ports comply with USB 2.0 & 3.0. Transmission rates could be up to 480 Mbps (USB 2.0) / 5Gbps (USB 3.0) and fuse protection are supported. The USB interface can be disabled in the system BIOS setup.

The ASMB-822I is equipped with two high-performance 1000 Mbps Ethernet LANs. They are supported by all major network operating systems. The RJ-45 jacks on the rear plate provide convenient 1000Base-T operation.

ASMB-822I is also equipped with the additional 100 Mbps Ethernet LAN (IPMI_LAN1 Port) which is shared with IPMI for system management.

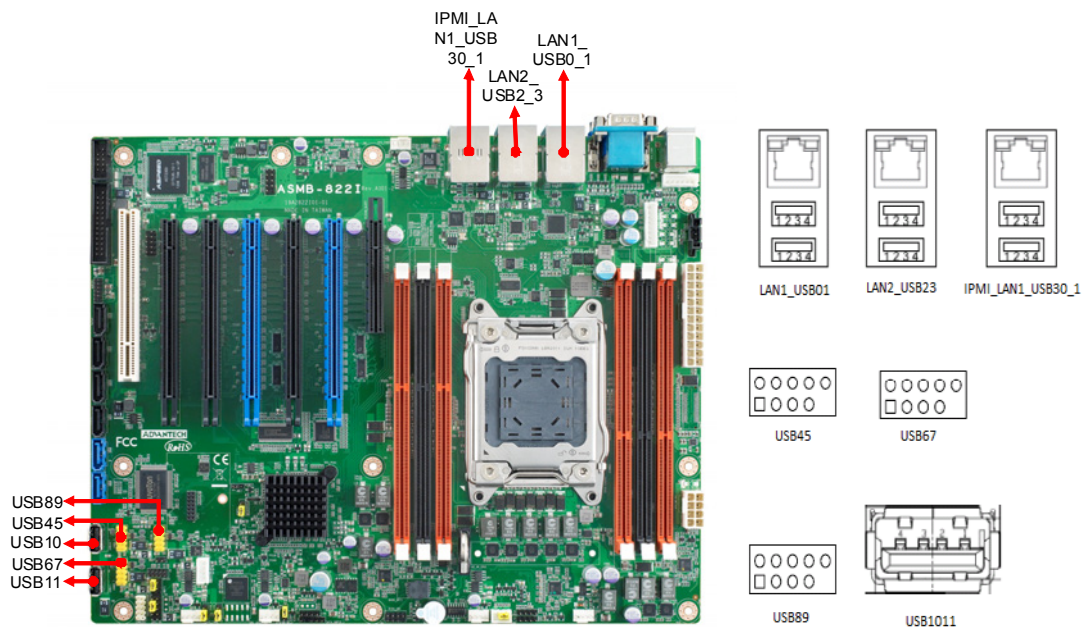

Example: Set USB45 (pin definitions are the same as USB67 & USB89)

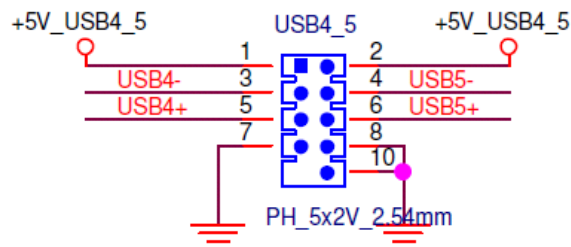

2.3 VGA Connector

The ASMB-822I includes a VGA interface that can drive conventional CRT and LCD displays.

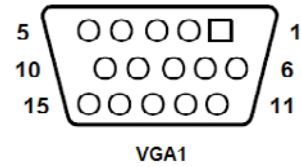
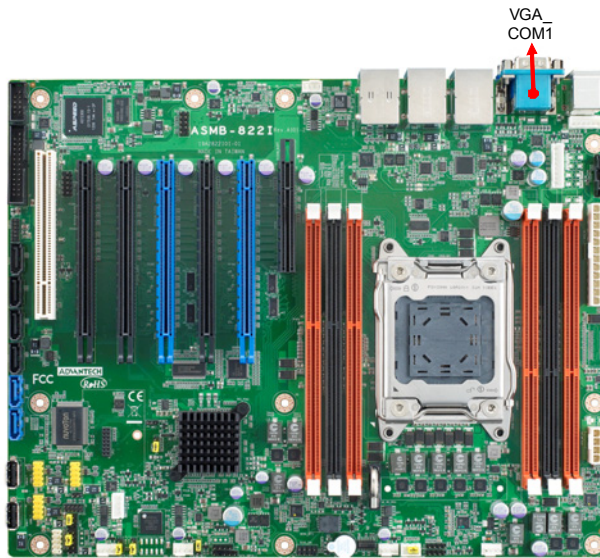

2.4 Serial Ports (COM1/COM2)

The ASMB-822I offers 2 serial ports (One on the rear panel and one onboard).

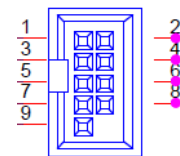
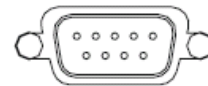
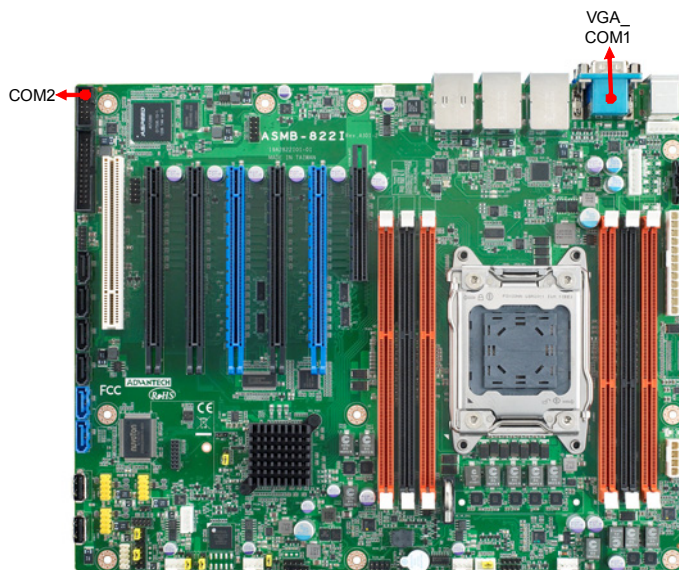

2.5 PS2 Keyboard and Mouse Connectors (KBMS1/KBMS2)

Two 6-pin mini-DIN connectors (KBMS1) on the rear panel of the motherboard provide PS/2 keyboard and mouse connections.

KBMS2 connector is for additional keyboard & mouse device usage.

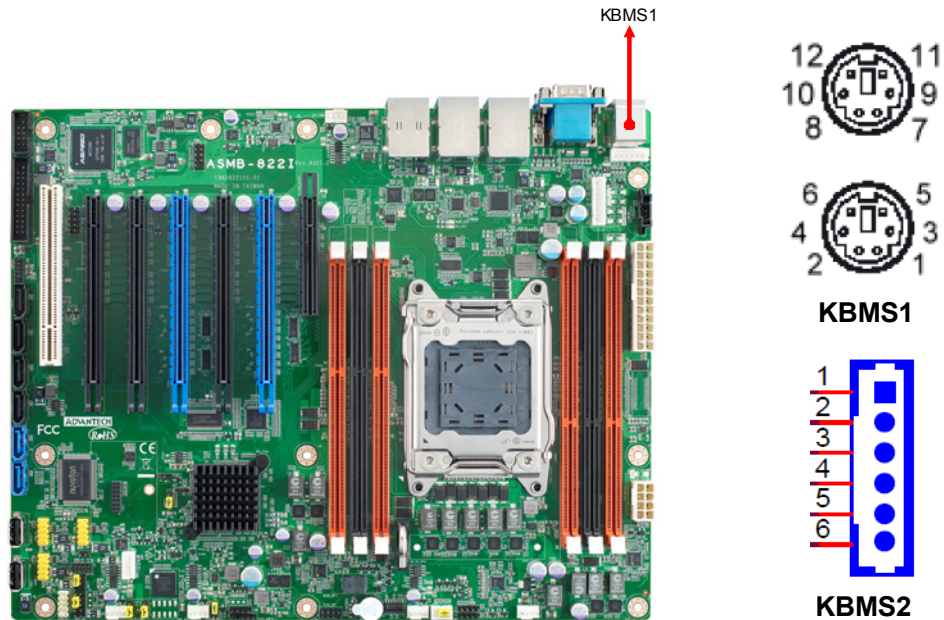

2.6 CPU Fan Connector (CPU FAN0)

If a fan is used, this connector supports cooling fans that draw up to 500 mA (6 W).

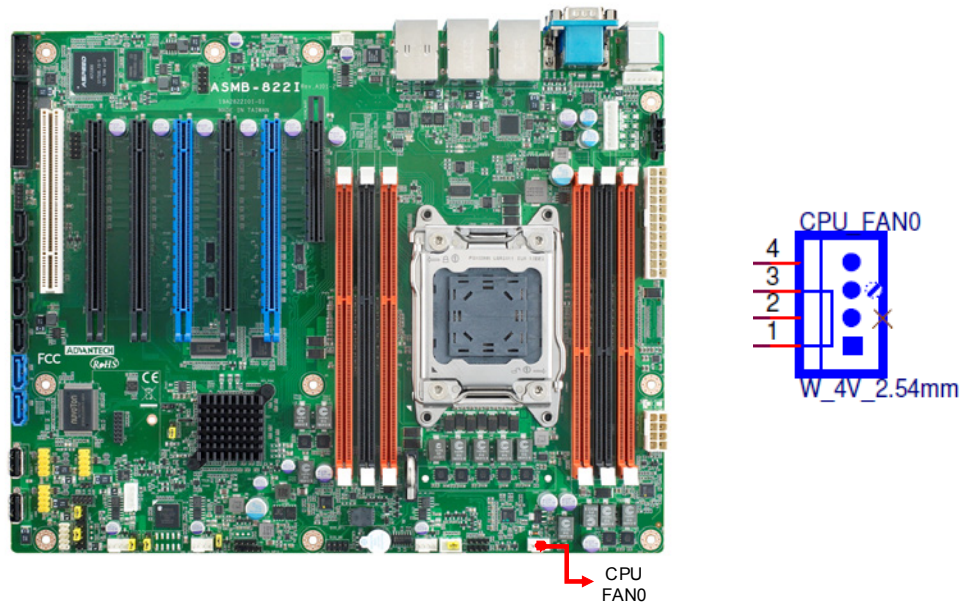

Table 2.1: CPU FAN0 Pin Definition

1	GND
2	+12V
3	CPU0_TACH
4	CPU0_PWM

2.7 System Fan Connector (SYS FAN0/FAN1)

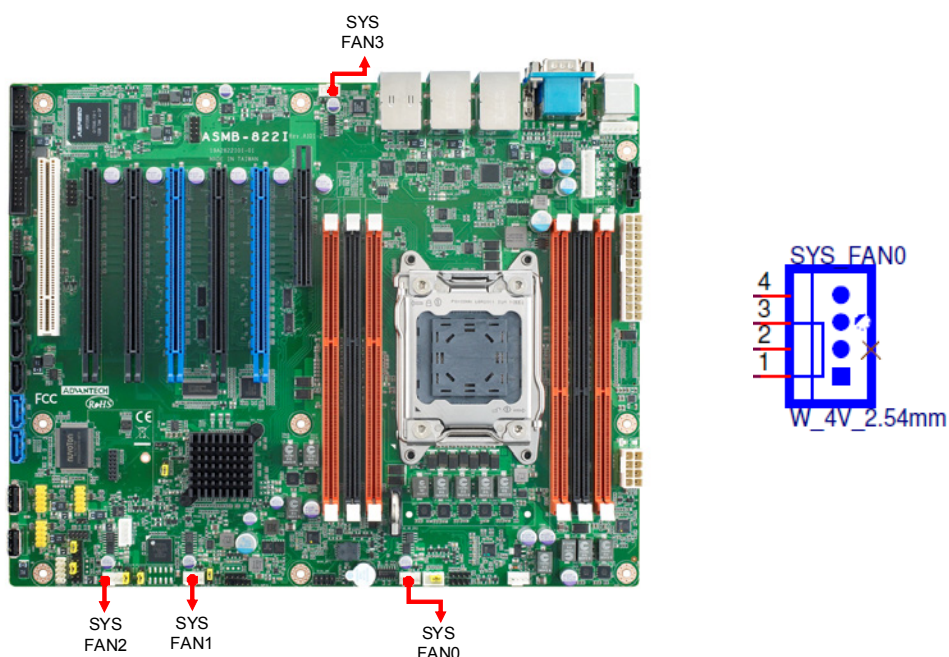
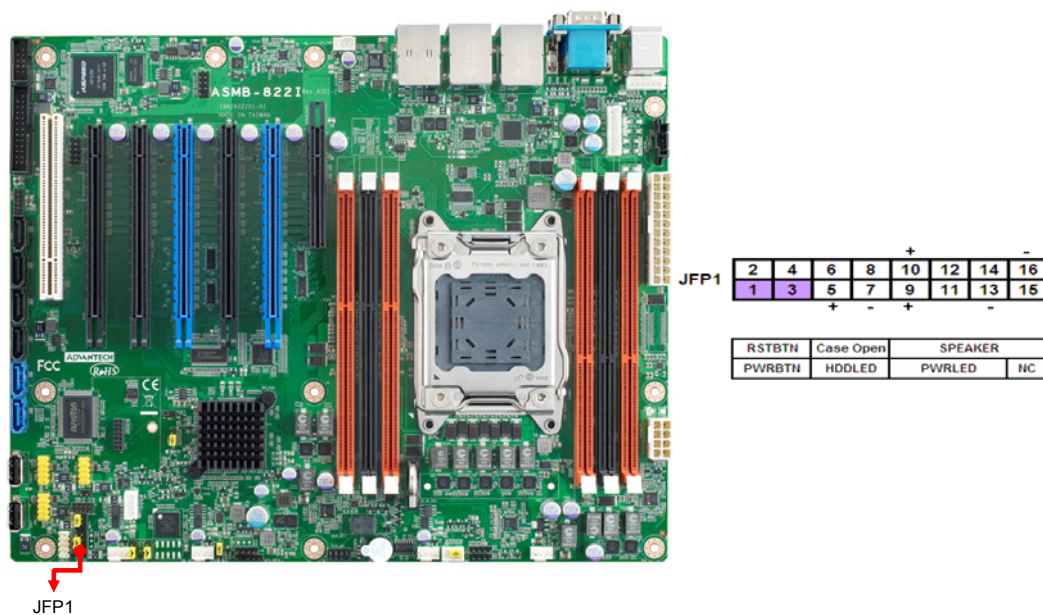

Table 2.2: SYS FAN0 Pin Definition

	SYS FAN0	SYS FAN1
1	GND	GND
2	+12V	+12V
3	FAN0_TACH	FAN1_TACH
4	FAN0_PWM	FAN1_PWM

2.8 Front Panel Connector (JFP1)

There are several external switches and LEDs to monitor and control the ASMB-8221.



2.8.1 Power LED (JFP1)

JFP1 pin 9 and pin 13 are for the power LED. Refer to Appendix B for detailed information on the pin assignments. If an ATX power supply is used, the system's power LED status will be as indicated as follows.

Table 2.3: ATX Power Supply LED Status

ACPI Power Mode	LED (ATX power)
System On (S0)	On
System Standby (S1)	Fast flashes
System Hibernation(S4)	Slow flashes
System Off (S5)	Off

2.8.2 External Speaker (JFP1 pins 10, 12, 14, 16)

JFP1 pins 10, 12, 14, 16 connect to an external speaker. The ASMB-822I provides an onboard buzzer as an alternative. To enable the buzzer, set pins 14-16 closed.

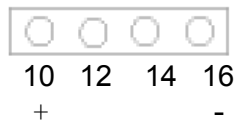

2.8.3 HDD LED Connector (JFP1 Pins 5 & 7)

You can connect an LED to connector JFP1 to indicate when the HDD is active.

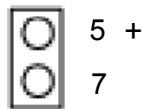

2.8.4 Reset Connector (JFP1 Pins 2 & 4)

Many computer cases offer the convenience of a reset button.

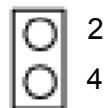

2.8.5 Case Open (JFP1 Pins 6 & 8)

A Chassis Intrusion header is located at JFP1 on the motherboard. Attach the appropriate cable from the chassis to be informed of a chassis intrusion when the chassis is opened.

The defaults function is disabled and Pin 6-8 are shorted by jumper cap.

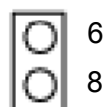

2.9 SATA SGPIO (SATA_SGPIO1)

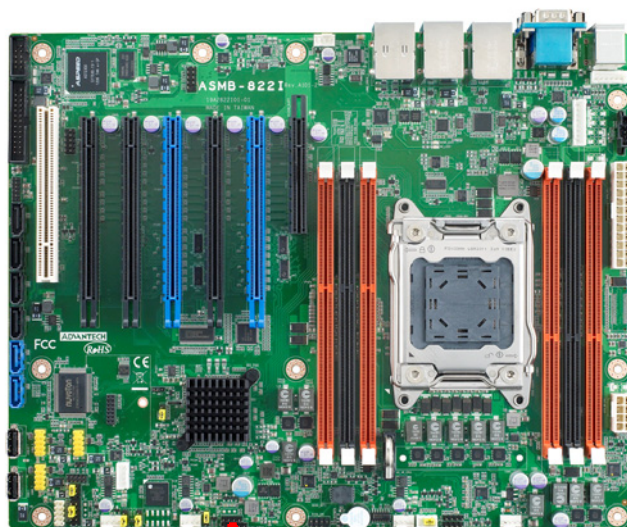

SATA_SGPIO1

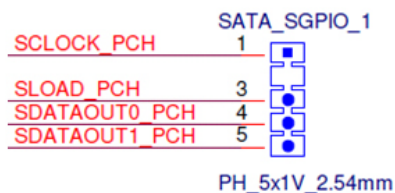

2.10 Front Panel LAN Indicator Connector (LANLED1)

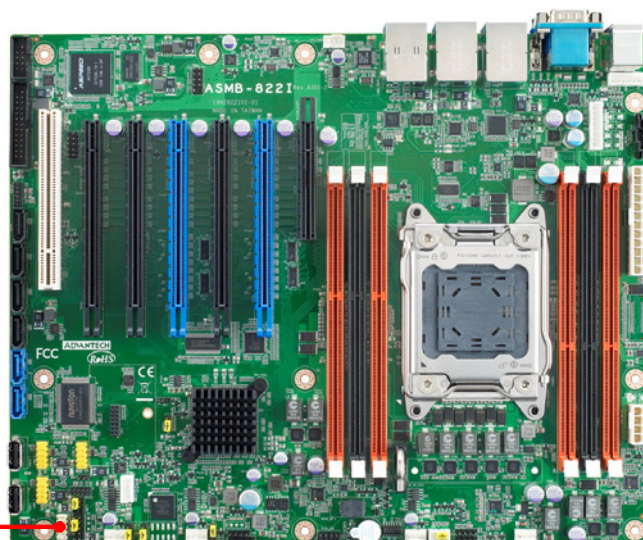

LANLED1

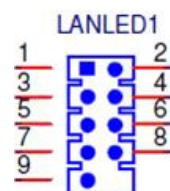

1	LAN1_LED0_ACT	2	LAN2_LED1_ACT
3	VCC3_LAN1LED	4	VCC3_LAN2LED
5	LAN1_LED1_1000M	6	LAN2_LED2_1000
7	LAN1_LED2_100M	8	LAN2_LED0_100
9	VCC3	10	NC

2.11 Serial ATA Interface (SATA0 ~ 5)

ASMB-822I features two serial ATA III (SATA 0 & SATA 1) interfaces (up to 600 MB/s) and four serial ATA II (SATA 2 ~ SATA 5) interfaces (up to 300 MB/s) which ease cabling to hard drives with thin and long cables.

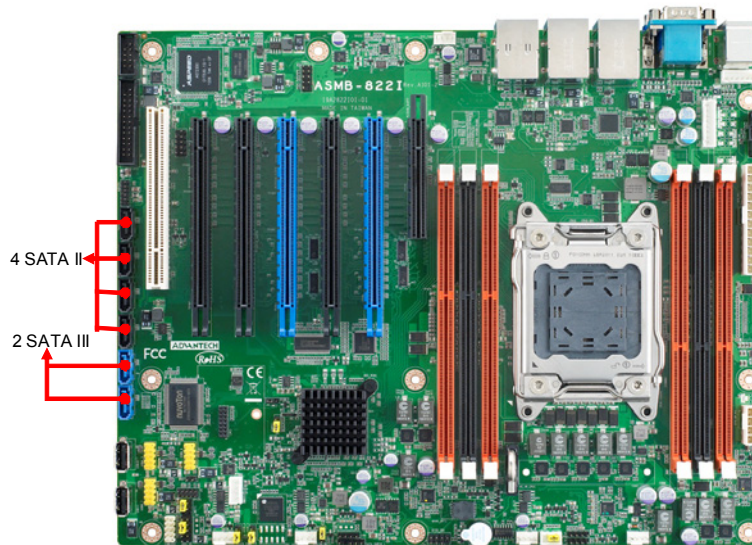

2.12 PCIe & PCI Expansion Slots

The ASMB-822I provides five PCIe and one PCI slots.

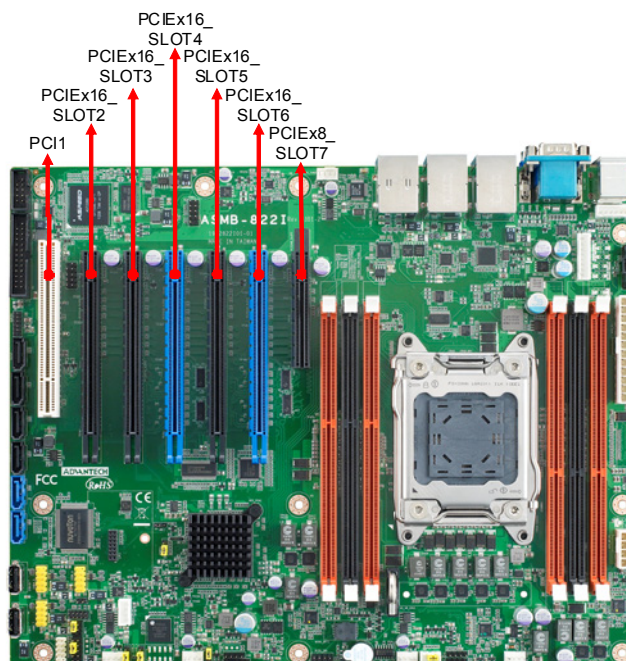

	Slot Length	Link	PCIe Generation	Auto switch Support
SLOT7	PCIe x8	PCIe x4	2	-
SLOT6	PCIe x16	PCIe x16 or x8	3	Y*
SLOT5	PCIe x16	PCIe x8	3	-
SLOT4	PCIe x16	PCIe x16 or x8	3	Y*

SLOT3	PCIe x16	PCIe x8	3	-
SLOT2	PCIe x16	PCIe x8	3	-
SLOT1	PCI	-	-	-

- Note!**
1. If you plug one expansion card in slot 6, the signal links will be PCIe x16.
 2. If you plug two expansion cards both in slot 6 & 5, the signal links of slot 6 & 5 will be both PCIe x8, the x8 links of slot 5 is provided by slot 6.
 3. Slot 4 has the same "Auto switch" function as slot 6.



2.13 Auxiliary Power Connector (ATX24P_P1/ ATX8P_P1)

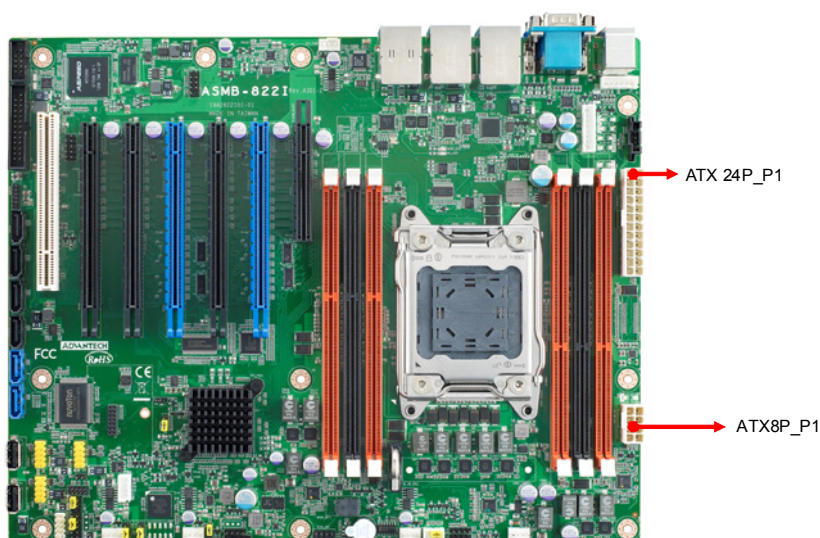

- Note!**
1. Please use a power supply which is of SSI type; minimum output should be at least 650 W.
 2. ATX 8P_P1 & ATX 24P_P1 sockets should be connected with power supply, otherwise ASMB-822I will not boot up normally.



2.14 HD Audio Interface Connector (AUDIO1)

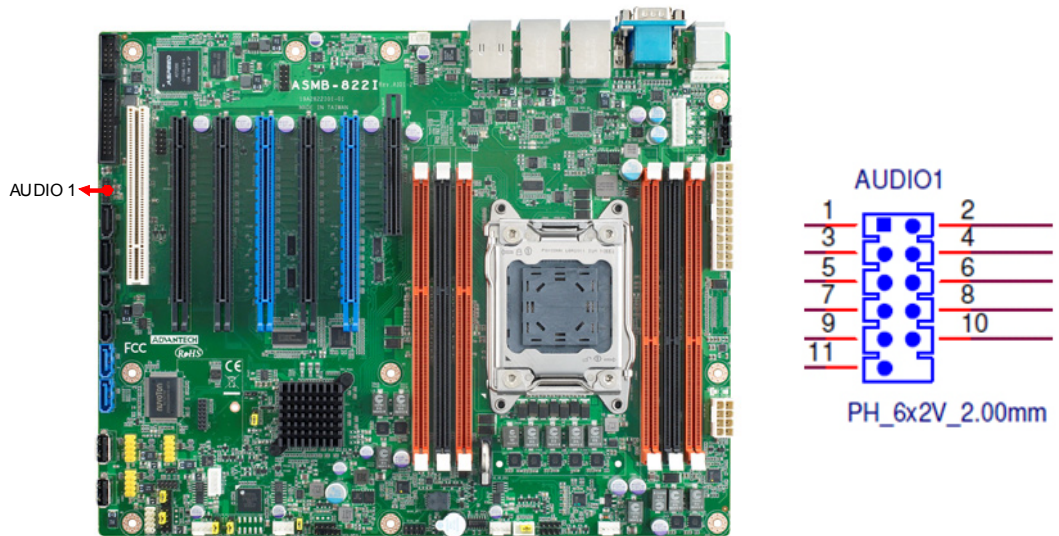

1	+5 V_AUD	2	GND
3	ACZ_SYNC	4	ACZ_BITCLK
5	ACZ_SDOUT	6	ACZ_SDIN0
7	ACZ_SDIN1	8	ACZ_RST#
9	+AC_12V	10	GND
11	GND	12	NC

2.15 LPC Connector (LPC1) for Optional TPM Module

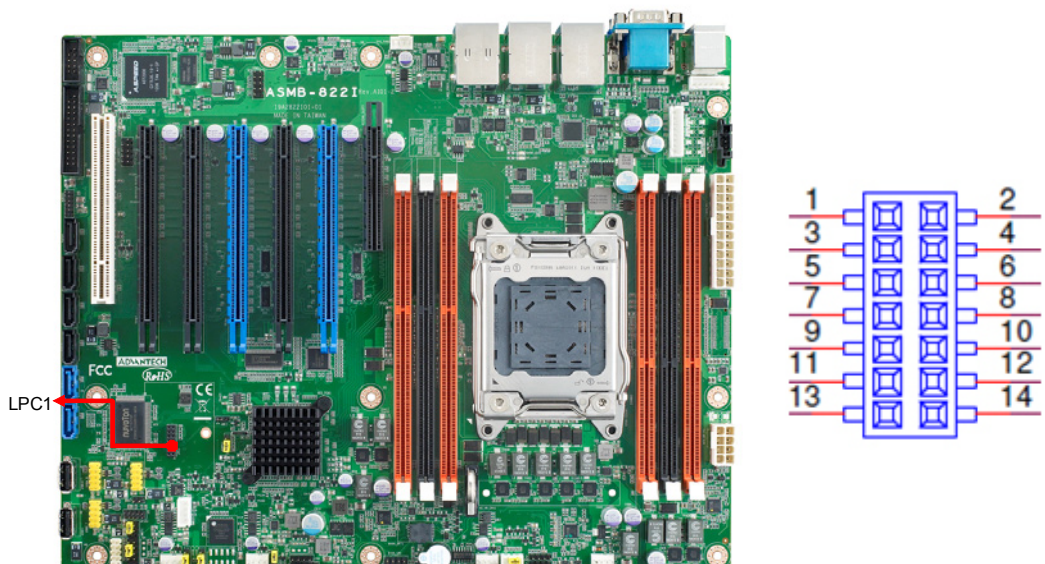

1	CLK_33M_TPM	2	LPC_AD1
3	PLTRST_LPC	4	LPC_AD0
5	LPC_FRAME	6	+3.3 V
7	LPC_AD3	8	GND

9	LPC_AD2	10	SMB_SCL_LPC
11	SERIRQ_PCH	12	SMB_SDA_LPC
13	+5V_AUX	14	+5V

2.16 Clear CMOS Connector (JCMOS1)

Setting jumper from pin 1_2 to pin 2_3, then back to pin 1_2 to reset CMOS data.

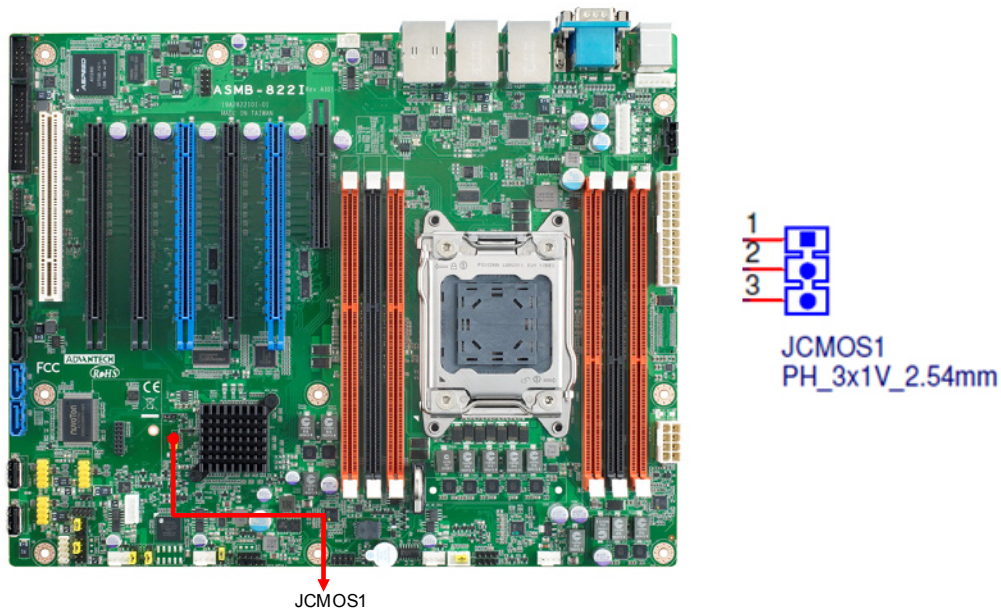

1	SRTC_RST_PCH
2	RTC_RST_PCH
3	GND

2.17 PMBUS Connector (PMBUS1)

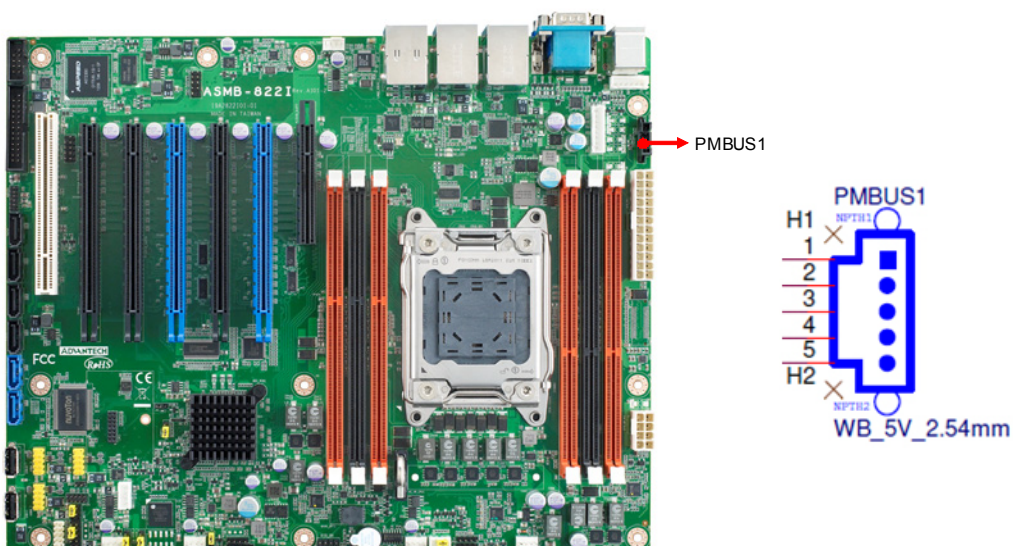

1	SMB_SCL_PM
---	------------

2	SMB_SDA_PM
3	SMB_ALT_PM
4	GND
5	+3.3V

2.18 Front Panel SMBUS Connector (SMBUS1)

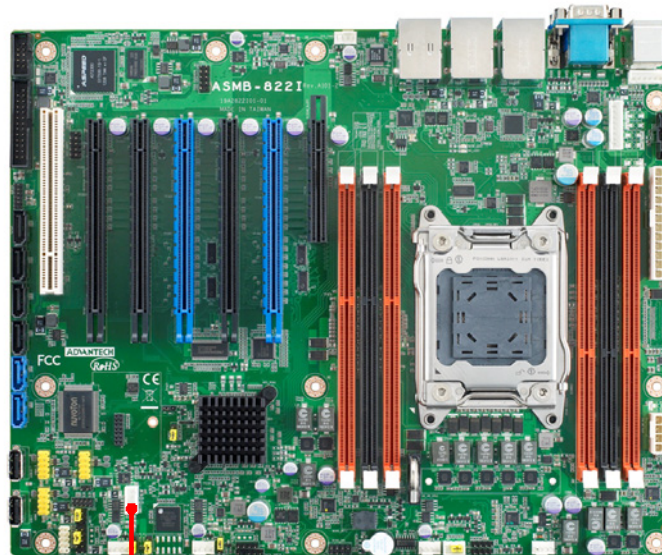

SMBUS1

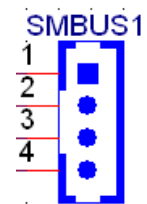

1	+3.3V_AUX
2	SMB_SCL_FRU
3	SMB_SDA_FRU
4	GND

2.19 IPMI Module Connector (IPMI1)

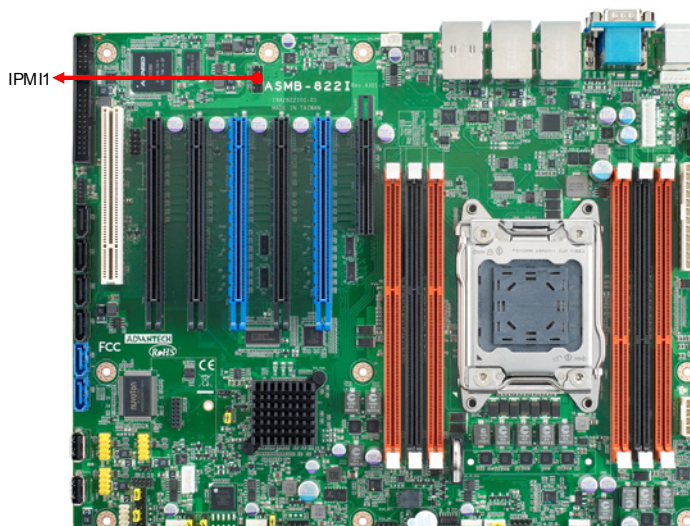

IPMI1

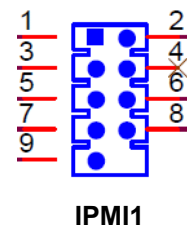

This connector only fit to ASMB-BMC-00A1E and only exist in ASMB-822I sku.

2.20 VOLT1 Connector

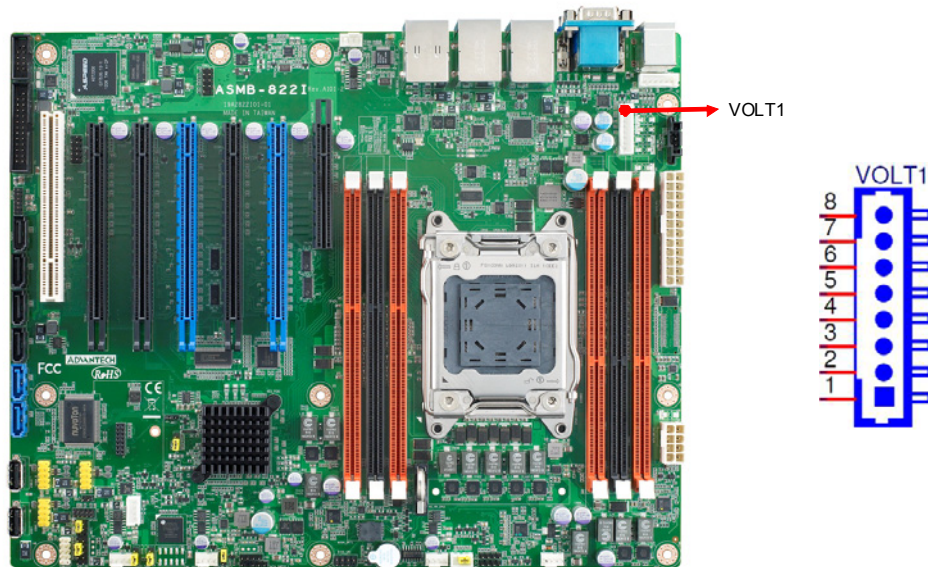

VOLT1 connects to the alarm board of Advantech chassis. These alarm boards give warnings if a power supply or fan fails, if the chassis overheats, or if the backplane malfunctions.

1	5VSB	5	+5V
2	GND	6	+3.3V
3	GND	7	-12V
4	-5V	8	+12V

2.21 GPIO Connector

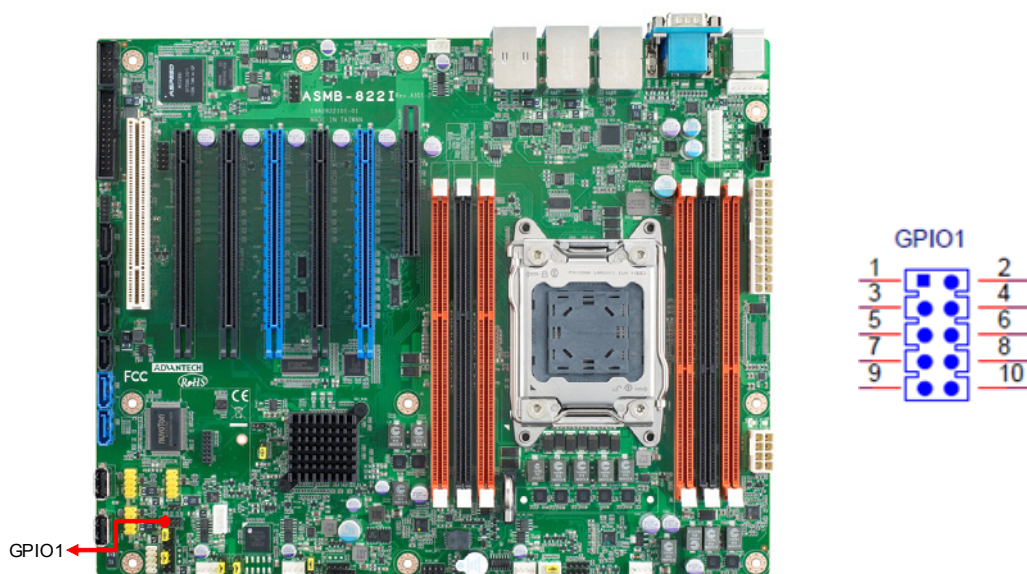

1	SIO_GPIO0	2	SIO_GPIO4
3	SIO_GPIO1	4	SIO_GPIO5
5	SIO_GPIO2	6	SIO_GPIO6
7	SIO_GPIO3	8	SIO_GPIO7
9	VCC_GPIO0	10	GND

2.22 SNMP Connector

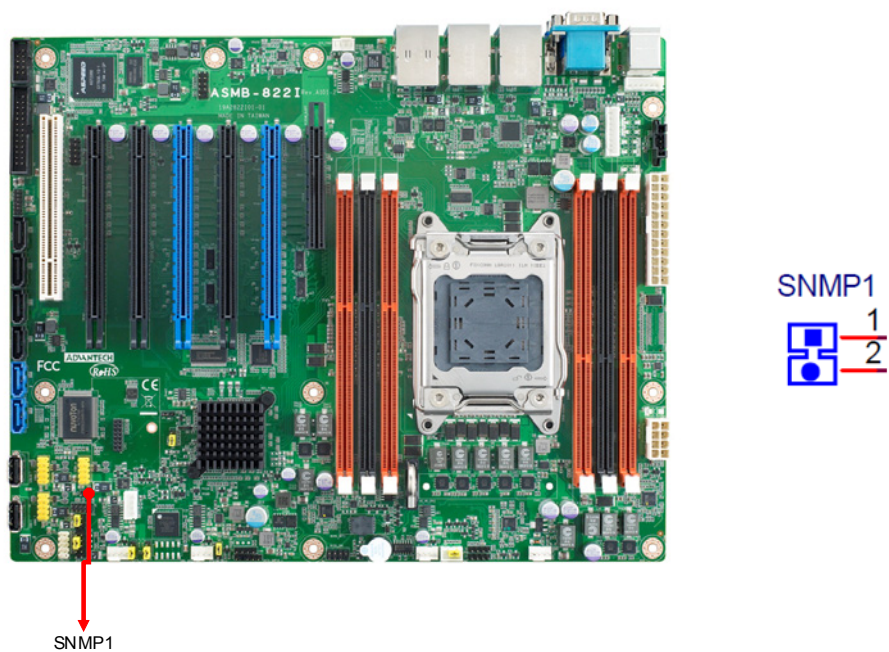

SNMP connector could apply with “SAB-2000” remote control board to monitor the situation of ASMB-822I through super IO chip.

1	SNMP_SDA	2	SNMP_SCL
---	----------	---	----------

Chapter 3

AMI BIOS

3.1 Introduction

AMI BIOS has been integrated into many motherboards for over a decade. In the past, people often referred to the AMI BIOS setup menu as BIOS, BIOS setup or CMOS setup. With the AMI BIOS Setup program, you can modify BIOS settings and control the special features of your computer. The Setup program uses a number of menus for making changes and turning the special features on or off. This chapter describes the basic navigation of the ASMB-822I setup screens.



AMI's BIOS ROM has a built-in Setup program that allows users to modify the basic system configuration. This type of information is stored in battery-backed up CMOS so it retains the Setup information when the power is turned off.

Note! *The BIOS setup screens shown in this chapter are just for reference only, it may not exactly match what you see on your display devices.*



3.2 BIOS Setup

3.2.1 Main Menu

Press to enter AMI BIOS CMOS Setup Utility, the Main Menu will appear on the screen. Use arrow keys to select among the items and press <Enter> to accept or enter the sub-menu.

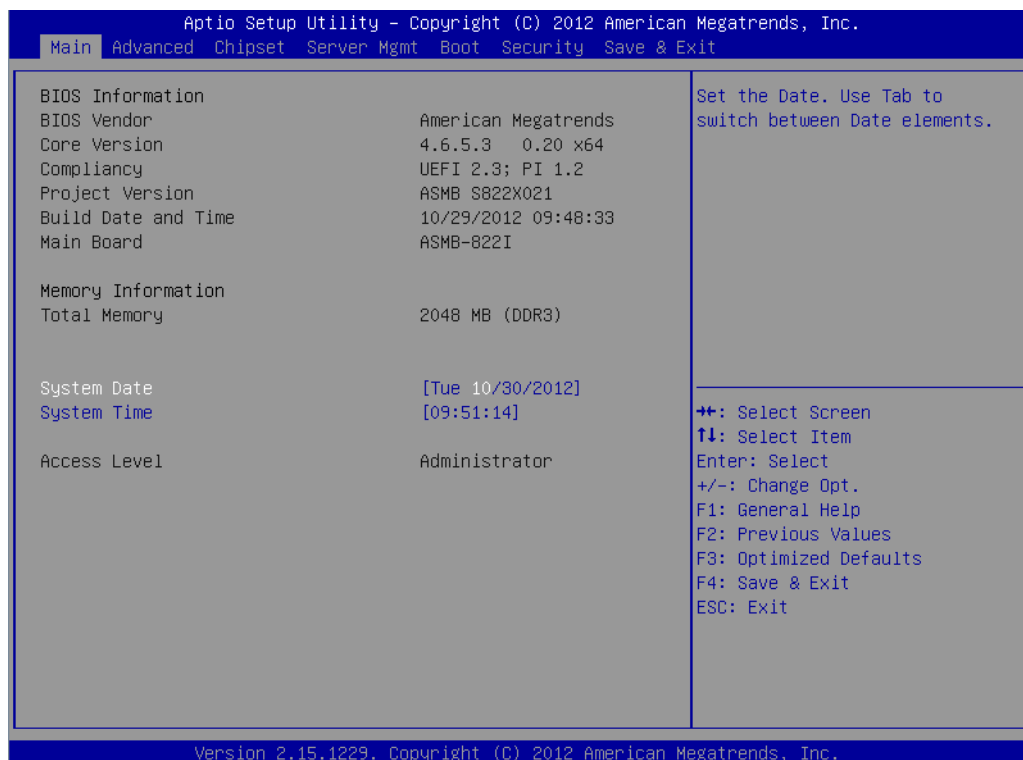

The Main BIOS setup screen has two main frames. The left frame displays all the options that can be configured. Grayed-out options cannot be configured; options in blue can be. The right frame displays the key legend. Above the key legend is an area reserved for a text message. When an option is selected in the left frame, it is highlighted in white. Often a text message will accompany it.

3.2.1.1 System Time / System Date

Use this option to change the system time and date. Highlight System Time or System Date using the <Arrow> keys. Enter new values through the keyboard. Press the <Tab> key or the <Arrow> keys to move between fields. The date must be entered in MM/DD/YY format. The time must be entered in HH:MM:SS format.

3.2.2 Advanced BIOS Features Setup

Select the Advanced tab from the ASMB-822I setup screen to enter the Advanced BIOS setup screen. You can select any of the items in the left frame of the screen, such as CPU configuration, to go to the sub menu for that item. You can display an Advanced BIOS Setup option by highlighting it using the <Arrow> keys. All Advanced BIOS Setup options are described in this section. The Advanced BIOS Setup screens are shown below. The sub menus are described on the following pages.

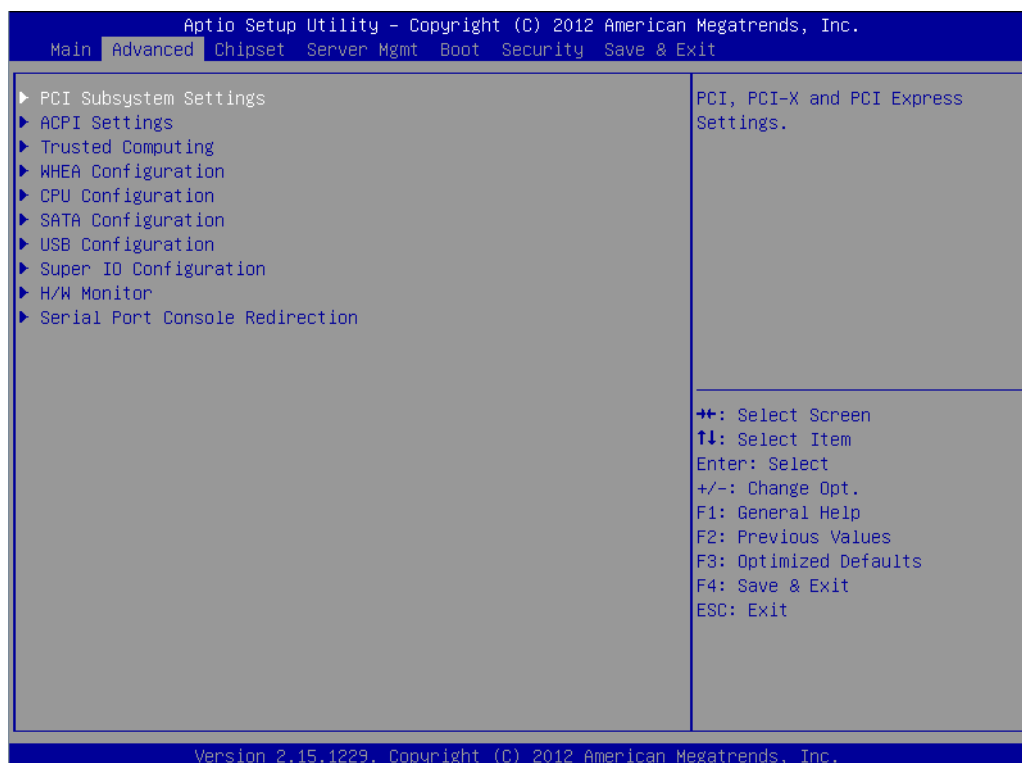

3.2.2.1 PCI Subsystem Settings



- **Above 4G Decoding**
Enables or disables 64-bit capability. Devices to be decoded in above 4G address space (Only if system supports 64bit PCI decoding).
- **PCI Latency Timer**
Value in units of PCI clocks for PCI device latency timer register.
- **VGA Palette Snoop**
Enables or disables VGA palette registers snooping.

3.2.2.2 ACPI Settings



- **Enable Hibernation**
"Enable or disable" Hibernation.
- **ACPI Sleep State**
Specifies the ACPI sleep state when the system enters standby.
- **Lock Legacy Resources**
"Enabled" or "Disabled" Lock Legacy Resources.

3.2.2.3 Trusted Computing

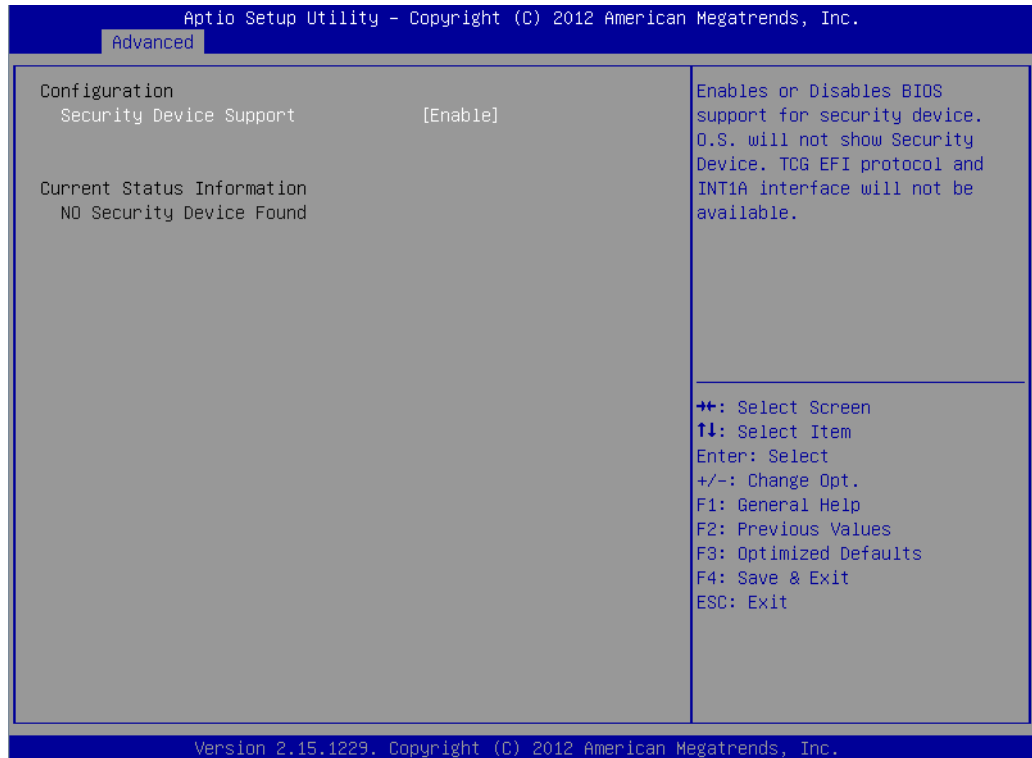

- **Security Device Support**
Enables or disables BIOS support for security device.
Purchase Advantech LPC TPM module to enable TPM function. P/N: PCA-TPM-00A1E.

3.2.2.4 WHEA Support

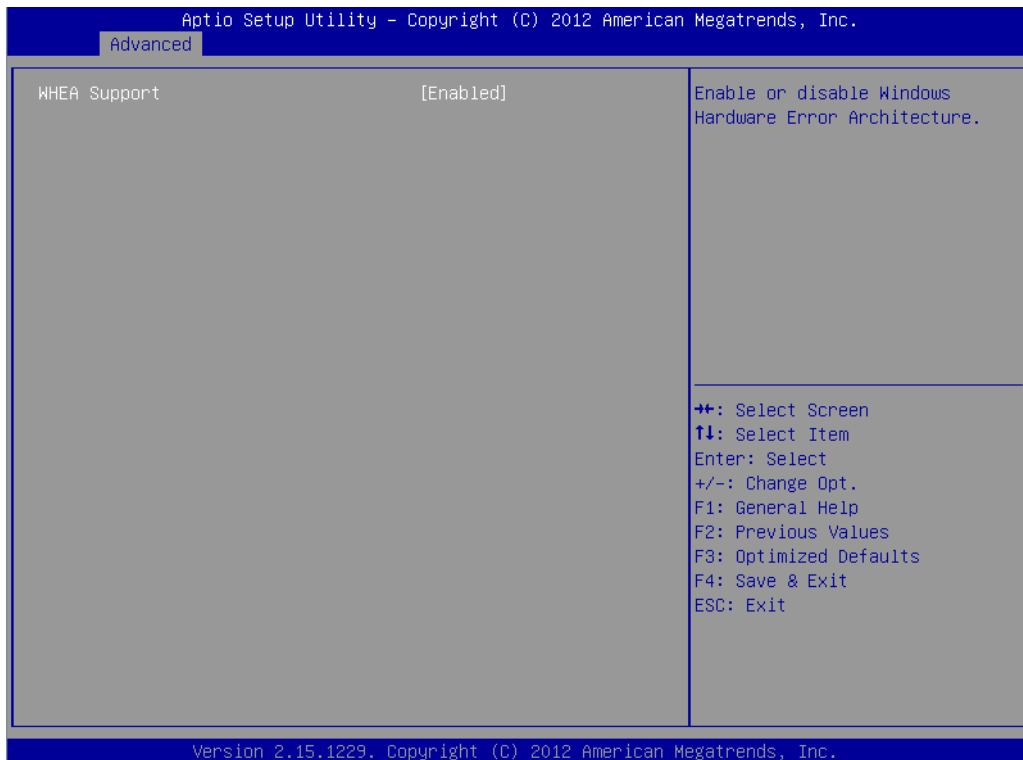

- **WHEA Support**
"Enable or disable" Windows Hardware Error Architecture.

3.2.2.5 CPU Configuration

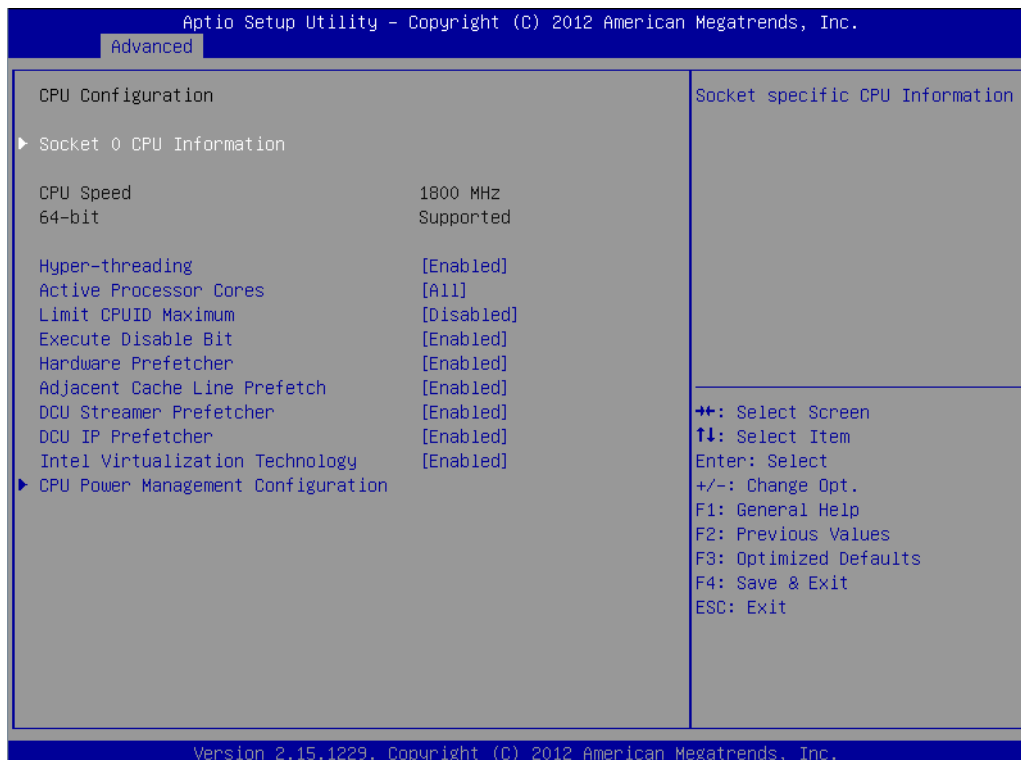

■ Socket 0 CPU Information

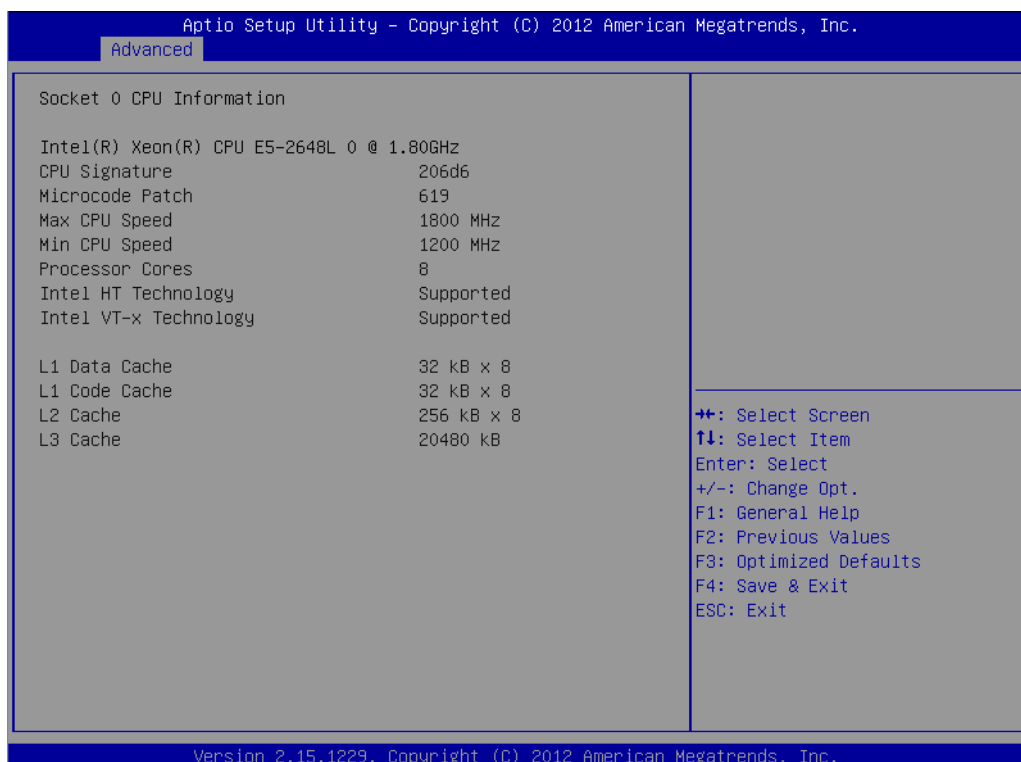

- **Hyper-threading**
Enable or disable Intel Hyper Threading technology.
- **Active Processor Core**
Select how many processor cores to activate when using a dual or quad core processor.
- **Limit CPUID Maximum**
Set this item to [Enable] allows legacy operating systems to boot even without support for CPUs with extended CPUID functions.
- **Execute Disable Bit**
This item specifies the Execute Disable Bit Feature. The settings are Enabled and Disabled. The Optimal and Fail-Safe default setting is Enabled. If Disabled is selected, the BIOS forces the XD feature flag to always return to 0.
- **Hardware Prefetcher**
Hardware Prefetcher is a technique that fetches instructions and/or data from memory into the CPU cache memory well before the CPU needs it, so that it can improve the load-to-use latency. Set to enable or disable.
- **Adjacent Cache Line Prefetch**
The Adjacent Cache-Line Prefetch mechanism, like automatic hardware prefetch, operates without programmer intervention. When enabled through the BIOS, two 64- byte cache lines are fetched into a 128-byte sector, regardless of whether the additional cache line has been requested or not. Set to enable or disable.
- **DCU Streamer Prefetch**
Enable prefetch of next L1 data line based upon multiple loads in same cache line.
- **DCU IP Prefetcher**
Enable prefetch of next L1 line based upon sequential load history.
- **Intel Virtualization Technology**
This feature is used to enable or disable the Intel Virtualization Technology (IVT) extension. It allows multiple operating systems to run simultaneously on the same system. It does this by creating virtual machines, each running its own x86 operating system.

■ CPU Power Management Configuration

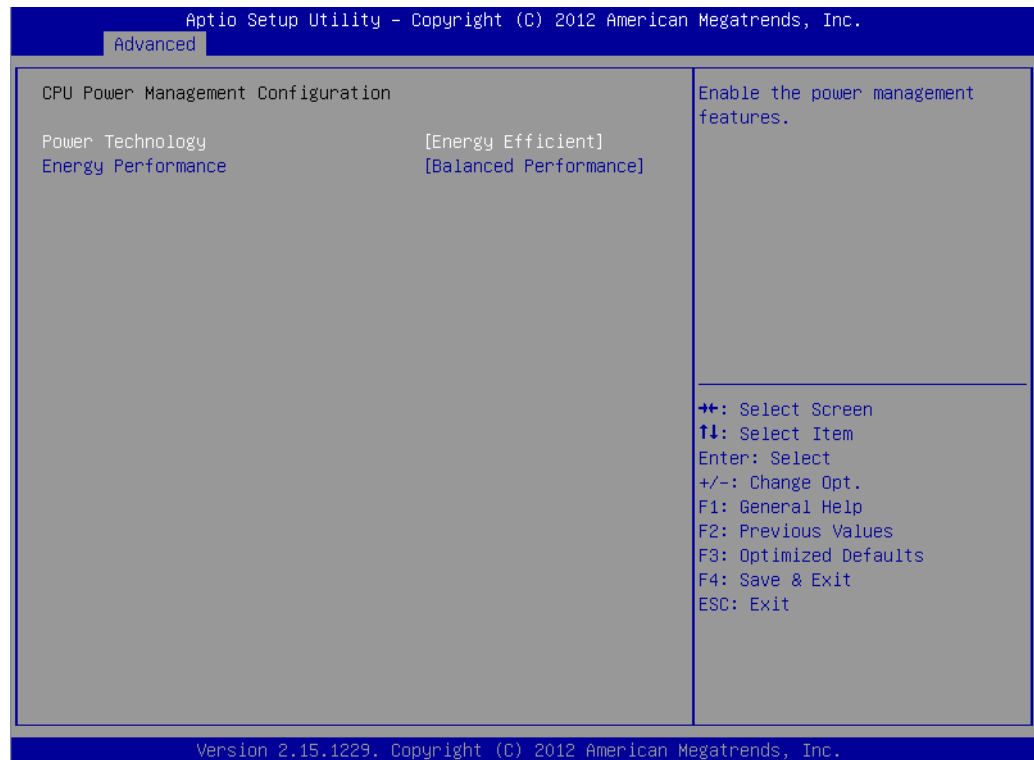

Power technology default is “Energy Efficient”.

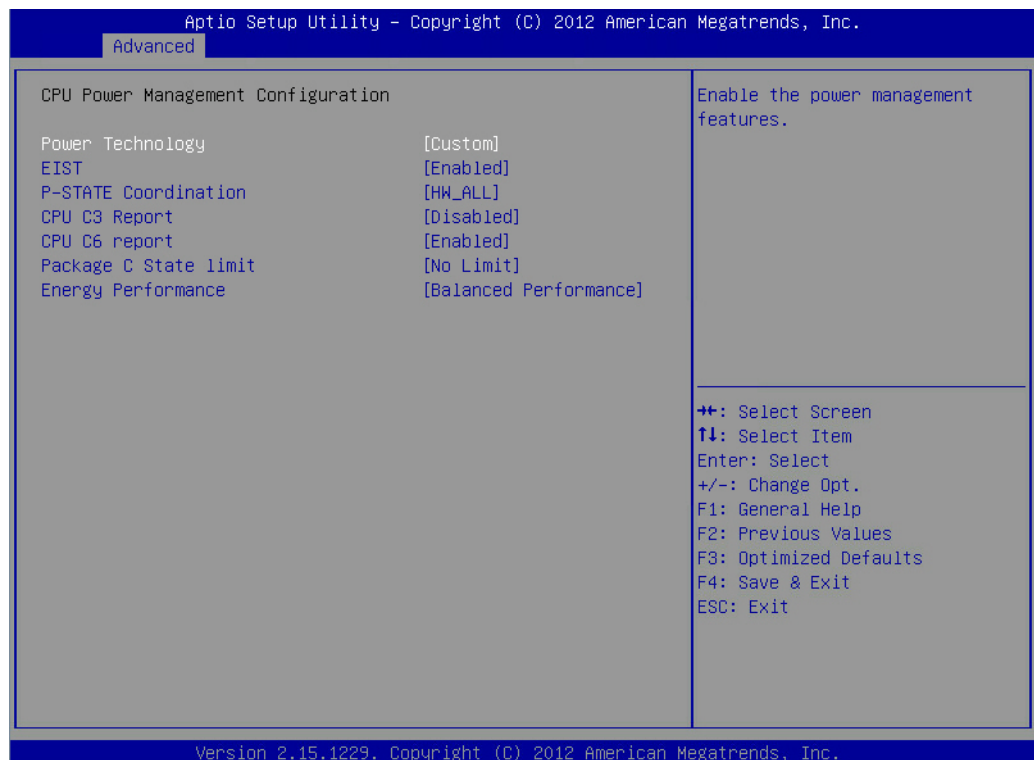

User can set “EIST”, “P-STATE”, “C3”, “C6”, “Package C State limit” under “Custom” Mode.

3.2.2.6 SATA Configuration

- **SATA Mode**
Configured as IDE/RAID/AHCI or Disabled.
- **IDE Mode**

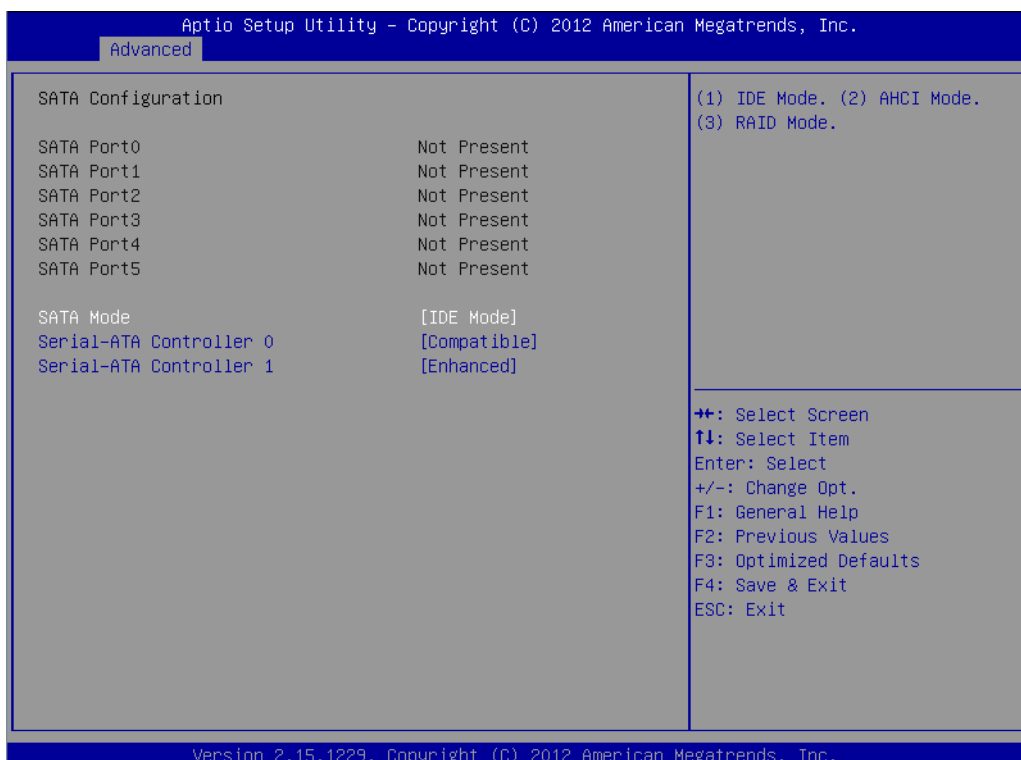

- **Serial-ATA Controller 0**
This item appears only when SATA Mode item set to [IDE Mode]. Set to [Enhanced] to support two SATA 6.0 Gb/s and four SATA 3.0 Gb/s devices. Set to [Compatible] when using Windows 98/NT/2000/MS-DOS. Up to four SATA devices are supported by controller 0 and two SATA devices are supported by controller 1 when under these operating systems.
- **Serial-ATA Controller 1**
This item appears only when SATA Mode item to [IDE Mode] is set. Set to [Enhanced] to support two SATA 3.0 Gb/s devices.

■ **AHCI Mode**

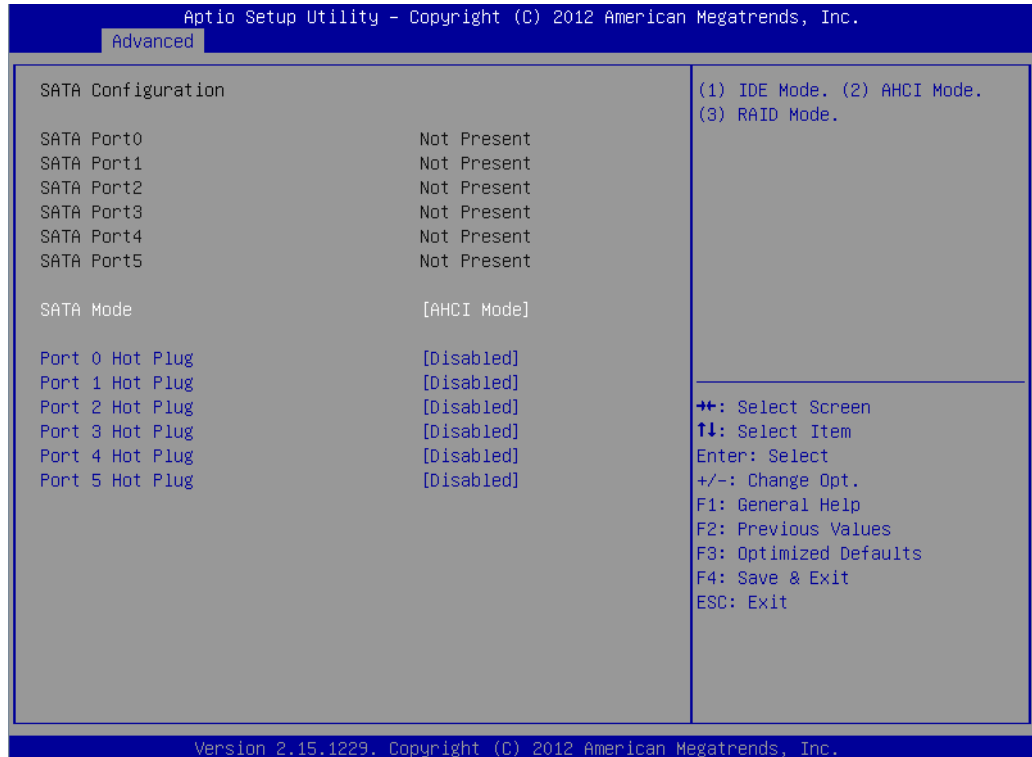

Set to [AHCI Mode] to have the SATA hard disk drives use the AHCI (Advanced Host Controller Interface). The AHCI allows the onboard storage driver to enable advanced Serial ATA features that increases storage performance on random workloads by allowing the drive to internally optimize the order of commands.

■ **RAID Mode**

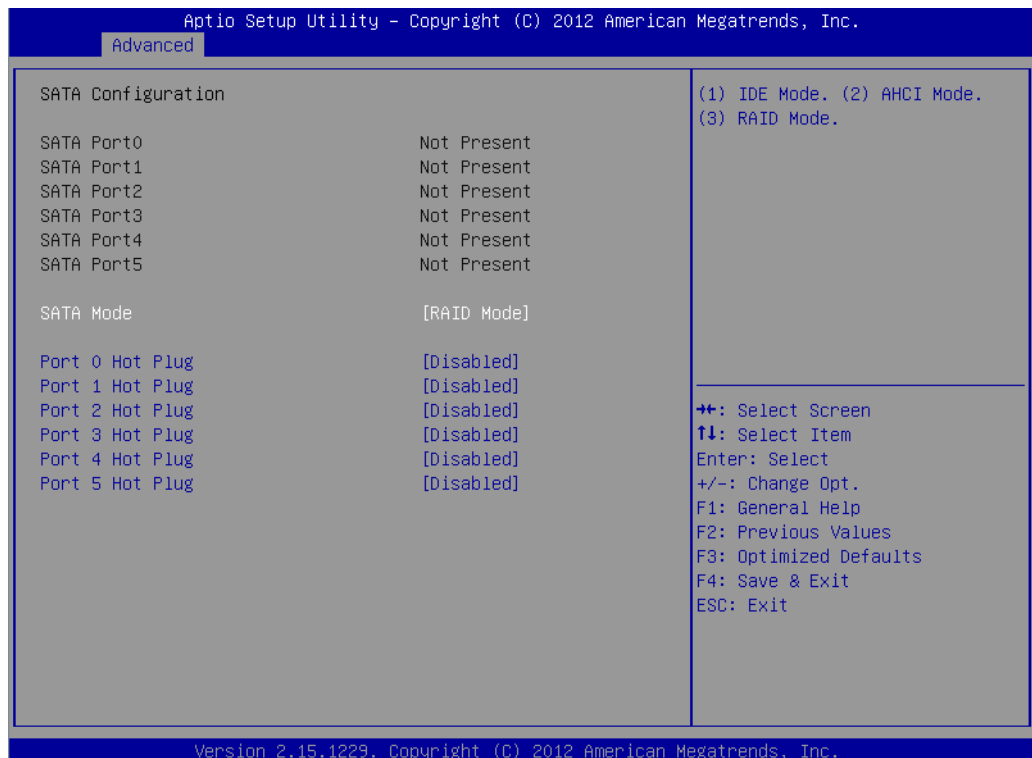

Set to [RAID Mode] to create a RAID configuration from the SATA hard disk drives.

3.2.2.7 USB Configuration

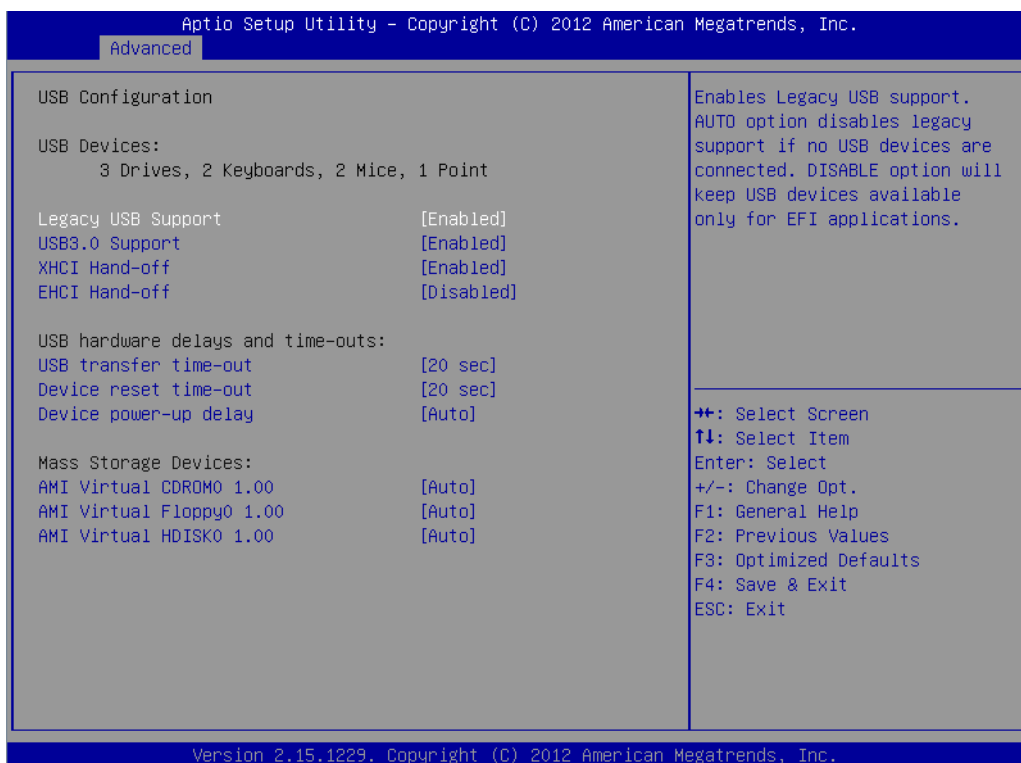

- **Legacy USB Support**
This is for supporting USB device under a legacy OS such as DOS. When choosing "AUTO", the system will automatically detect if any USB device is plugged into the computer and enable USB legacy mode when a USB device is plugged and disable USB legacy mode when no USB device is plugged.
- **USB3.0 support**
Enable/disable USB3.0(XHCI) controller support.
- **XHCI Hand-off**
This is a workaround for OS without XHCI hand-off support. The XHCI ownership change should be claimed by XHCI driver.
- **EHCI Hand-off**
This is a workaround for OS without EHCI hand-off support. The EHCI ownership change should be claimed by EHCI driver.
- **USB Transfer Time-out**
Selects the USB transfer time-out value. [1,5,10,20sec]
- **Device Reset Time-out**
Selects the USB device reset time-out value. [10,20,30,40 sec]
- **Device Power-up Delay**
This item appears only when Device power-up delay item is set to [manual].
- **Mass Storage Devices**
This item appears only when plugging in a USB flash device. User can choose "Auto", "Floppy", "Forced FDD", "Hard Disk" and "CD-ROM" to simulate USB flash device.

3.2.2.8 Super I/O Configuration



Serial Port 0 Configuration

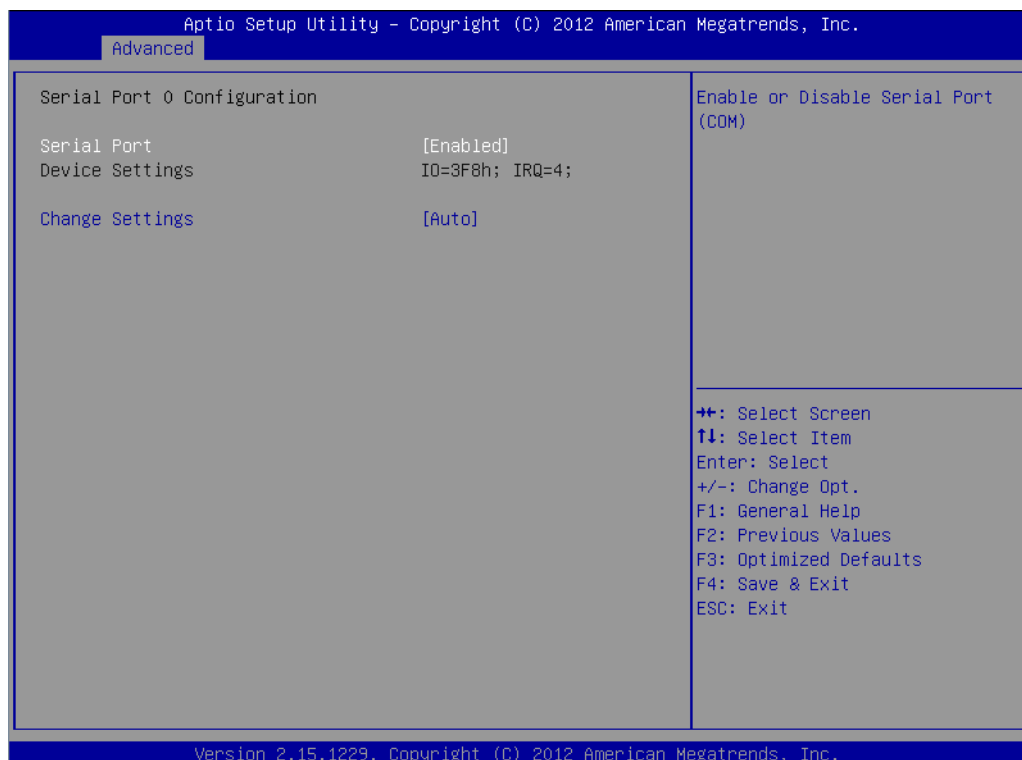

- **Serial Port**
To “enable” or “disable” Serial Port 0.
- **Change Settings**
To select an optimal setting for serial port 0.

Serial Port 1 Configuration

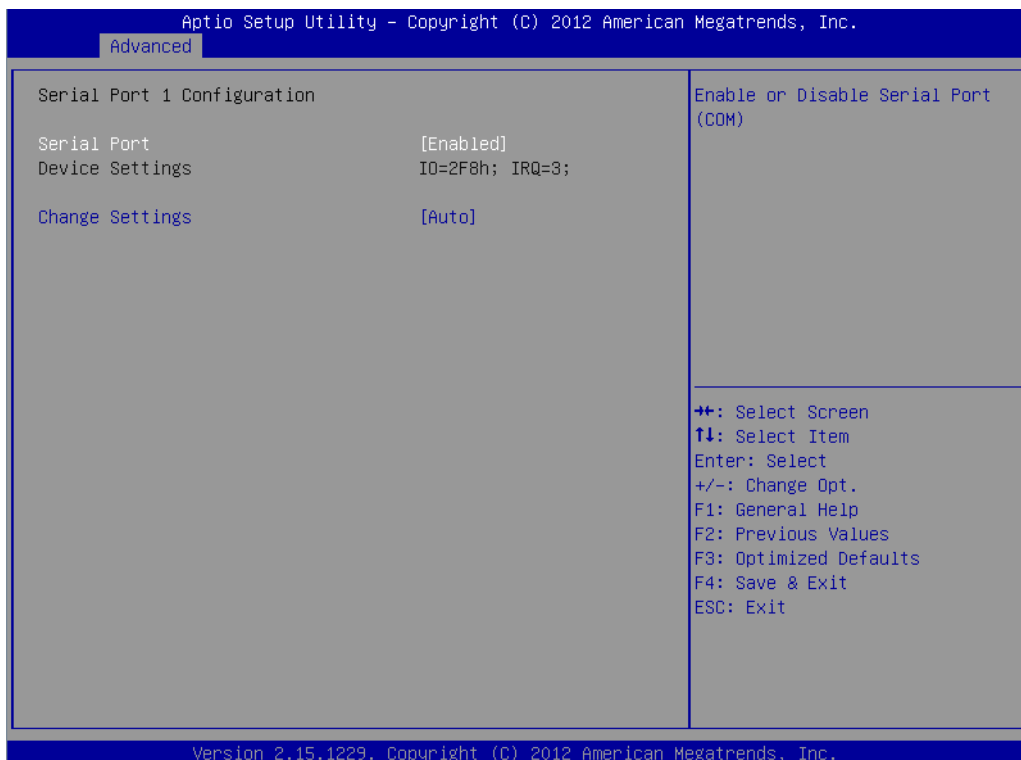

- **Serial Port**
To “enable” or “disable” Serial Port 1.
- **Change Settings**
To select an optimal setting for serial port 1.

3.2.2.9 Parallel Port Configuration



- **Parallel port**
Enable or disable parallel port (LPT/LPTE).
- **Change Settings**
Select an optimal setting for super IO device.
- **Device Mode**
Change the printer port mode.

3.2.2.10 H/W Monitor

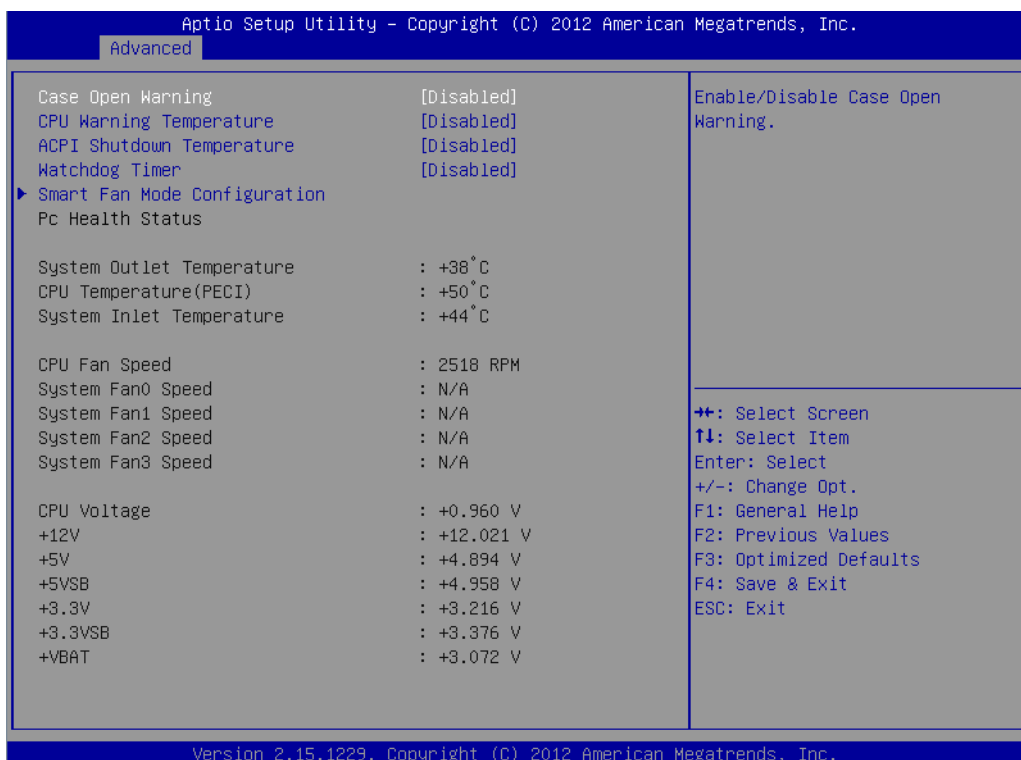

- **Case Open Warning**
Enable/Disable the Chassis Intrusion monitoring function. When enabled and the case is opened, the warning message will show in post screen.
- **CPU Warning Temperature**
Set the CPU warning temperature threshold. When the system reaches the warning temperature, the speaker will beep.
- **ACPI Shutdown Temperature**
Set the ACPI shutdown temperature threshold. When the system reaches the shutdown temperature, it will be automatically shut down by ACPI OS to protect the system from overheat damage.
- **Watchdog Timer**
Enable and Disable the watchdog timer function.
- **Smart Fan Mode Configuration**
When set to manual mode, fan duty setting can be changed; the range is from 0~255, default setting is 127.

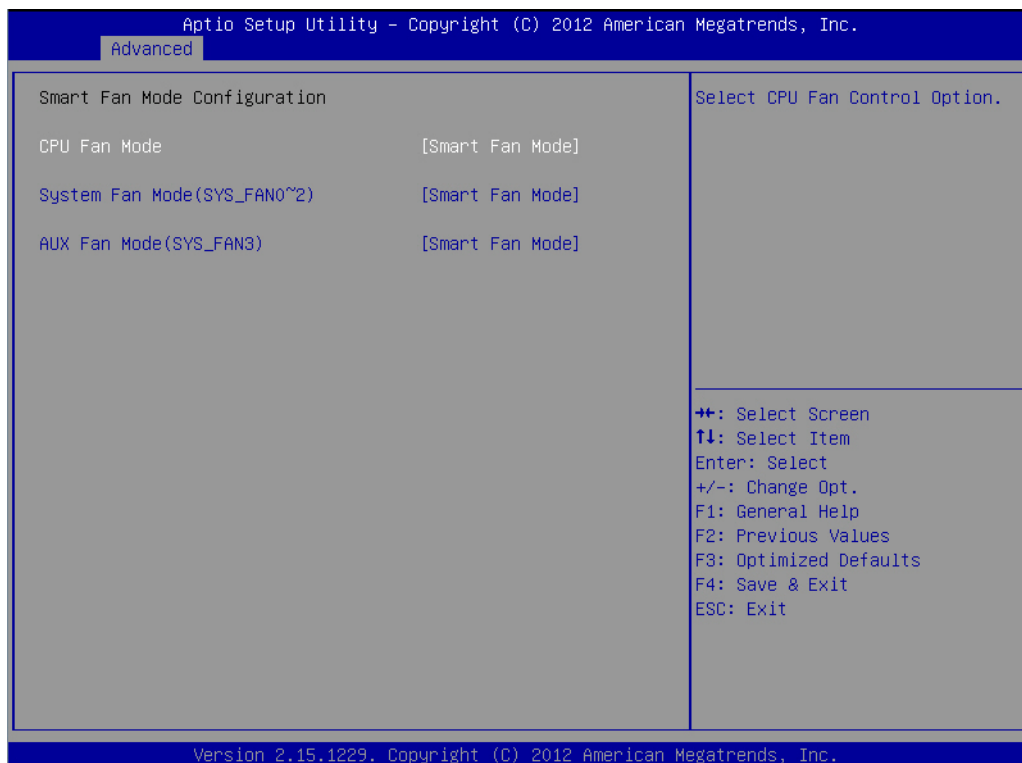

3.2.2.11 Serial Port Console Redirection

- **Console Redirection**

To “Enable or disable” console redirection feature.

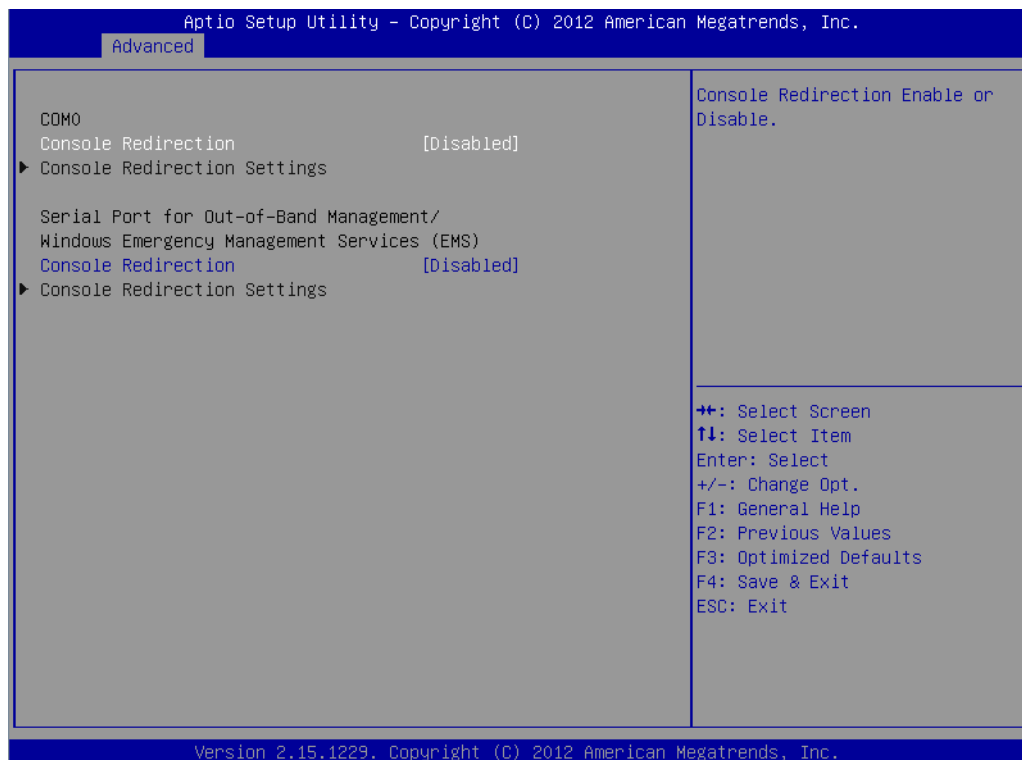

■ Console Redirection Settings

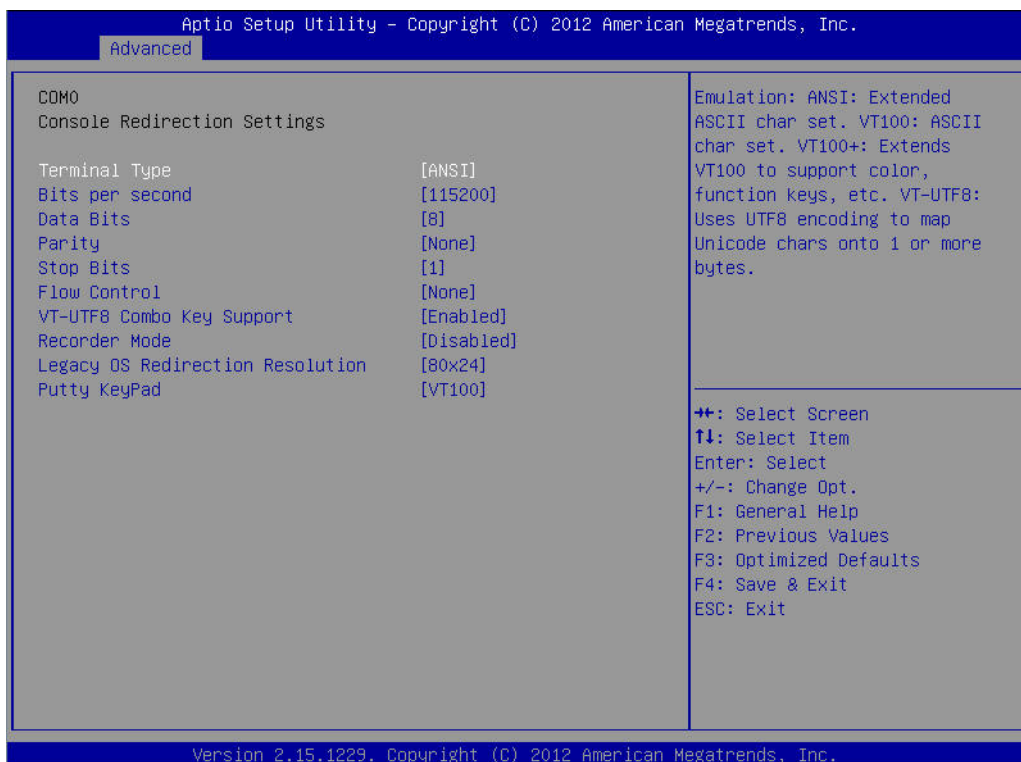

■ Terminal Type

Select a terminal type to be used for console redirection.
Options available: VT100/VT100+/ANSI /VT-UTF8.

■ Bits Per Second

Select the baud rate for console redirection.
Options available: 9600/19200/57600/115200.

■ Parity

A parity bit can be sent with the data bits to detect some transmission errors.
Even: parity bit is 0 if the num of 1's in the data bits is even.
Odd: parity bit is 0 if num of 1's the data bits is odd.
Mark: parity bit is always 1. Space: Parity bit is always 0.
Mark and Space Parity do not allow for error detection.
Options available: None/Even/Odd/Mark/Space.

■ Stop Bits

Stop bits indicate the end of a serial data packet. (A start bit indicates the beginning).
The standard setting is 1 stop bit. Communication with slow devices may require more than 1 stop bit.
Options available: 1/2.

■ Flow Control

Flow control can prevent data loss from buffer overflow. When sending data, if the receiving buffers are full, a 'stop' signal can be sent to stop the data flow. Once the buffers are empty, a 'start' signal can be sent to re-start the flow. Hardware flow control uses two wires to send start/stop signals.
Options available: None/Hardware RTS/CTS.

- **Recorder Mode**
When this mode enabled, only text will be send. This is to capture Terminal data.
Options available: Enabled/Disabled.
- **Legacy OS Redirection Resolution**
On Legacy OS, the number of Rows and Columns supported redirection.
Options available: 80x24/80X25.
- **Putty Keypad**
Select function key and keypad on putty.
- **Console Redirection Setting**

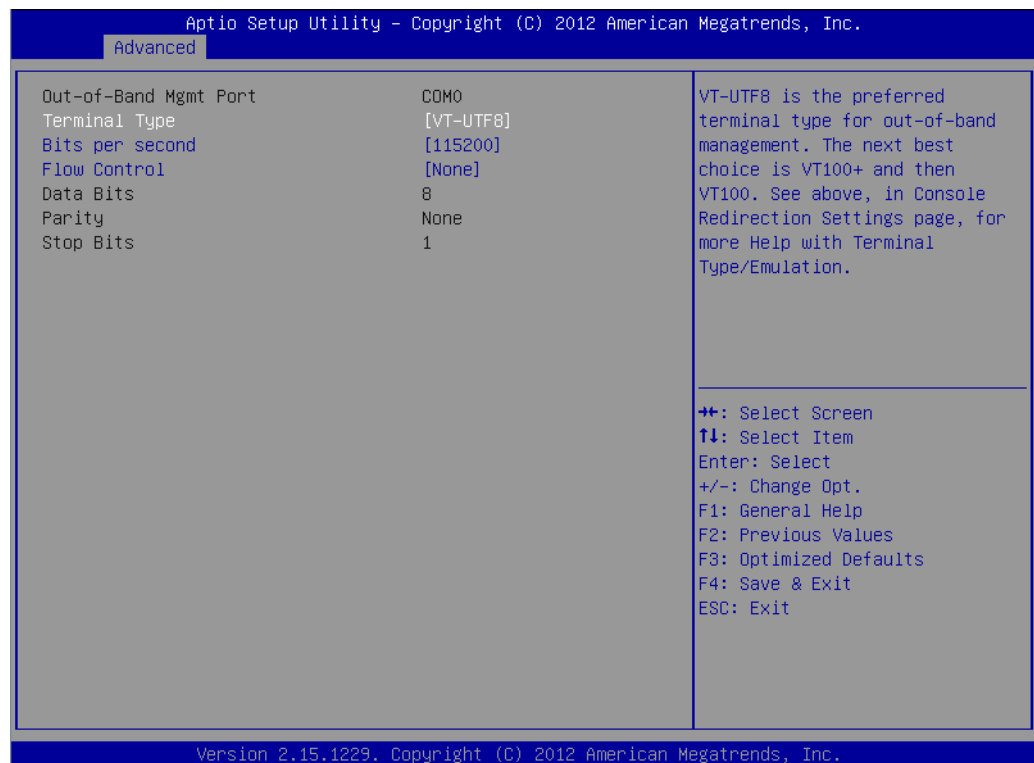

Out-of-Band Mgmt Port

To select the com port user would like to set for having console redirection feature.

Terminal Type

Set as "VT100", "VT100+", "VT-UTF8", or "ANSI". "VT-UTF8" is the default setting.

Bits Per Second

To select serial port transmission. Speed must be matched on the other side. It can be set as "9600", "19200", "57600", or "115200". "115200" is the default setting.

Flow Control

Flow control can prevent data loss from buffer overflow. It can be set as "None", "Hardware RTS/CTS", or "Software Xon/Xoff". "None" is the default setting.

3.2.3 Chipset



3.2.3.1 North Bridge

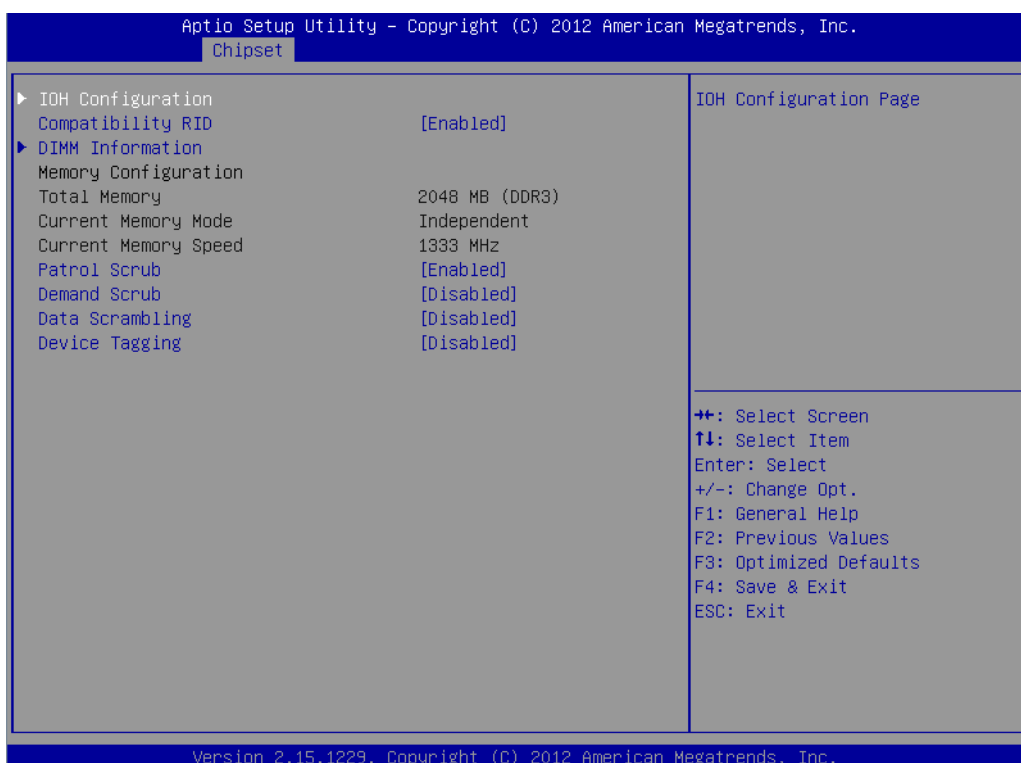

- **Patrol Scrub**
Enable/Disable patrol scrub feature.
- **Demand Scrub**
Enable/Disable demand scrub feature.

- **Data Scrambling**
Enable/Disable data scrambling.
- **Device Tagging**
Enable/Disable device tagging.

IOH Configuration



- **Intel I/OAT**
Enable/Disable Intel I/O Acceleration Technology function.
- **DCA Support**
Enable/Disable Direct Cache Access Support
- **VGA Priority**
Determines priority between onboard and 1st off-board video device found.
- **MMCFG Base**
Memory reservation for PCI/PCI-X/PCIe device of 32-bit operating system.
- **IOU 0 PCIe port Bifurcation control**
 - IOU 1- PCIe Port(PCIEX16_SLOT2)**
PORT 1A Link Speed
Select target link speed as Gen1, Gen2, Gen3
 - IOU2 - PCIe Port(PCIEX16_SLOT3 and SLOT4)**
 - 1.If plug only one expansion card in SLOT4, the PCIe link of SLOT4 will be x16.
 - 2.If plug expansion cards both in SLOT3 & SLOT4, the PCIe link will switch to two x8 for SLOT3 and SLOT4.
 - 3.If plug only one expansion card in SLOT3, the PCIe link of SLOT3 will be x8.
 - PORT 2A Link Speed**
Select target link speed as Gen1, Gen2, Gen3.

IOU3 - PCIe Port(PCIEX16_SLOT5 & SLOT6)

- 1.If plug only one expansion card in SLOT6, the PCIe link of SLOT6 will be x16.
- 2.If plug expansion cards both in SLOT5 and SLOT6, the PCIe link will switch to two x8 for SLOT5 and SLOT6.
- 3.If plug only one expansion card in SLOT5, the PCIe link of SLOT5 will be x8.
- 4.To set as x4x4x8 is for riser card "ASMB-RF348".
- 5.To set as x8x4x4 is for riser card "ASMB-RF3X8".

PORT 3A Link Speed

Select Target Link Speed as Gen1, Gen2, Gen3.

Intel® VT for Directed I/O Configuration

- **Intel VT-d**
Enable/Disable Intel Virtualization Technology for Directed I/O.

Compatibility RID

Support for Compatibility Revision ID (CRID). Functionality mentioned in BIOS spec.

DIMM Information

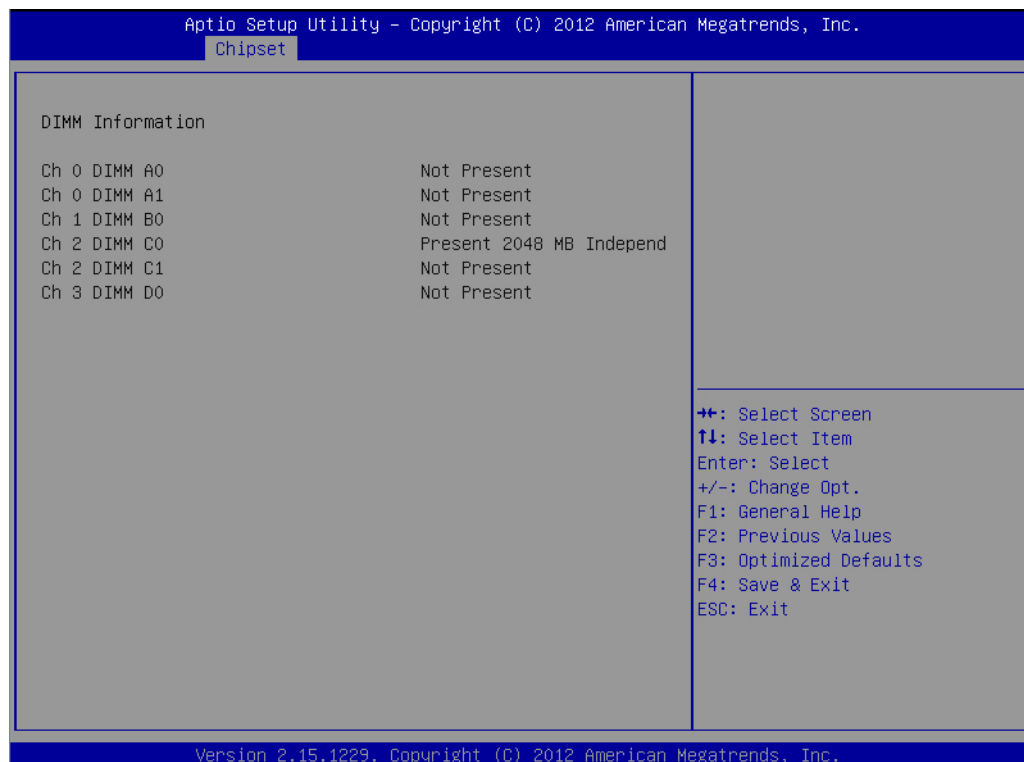

3.2.3.2 South Bridge

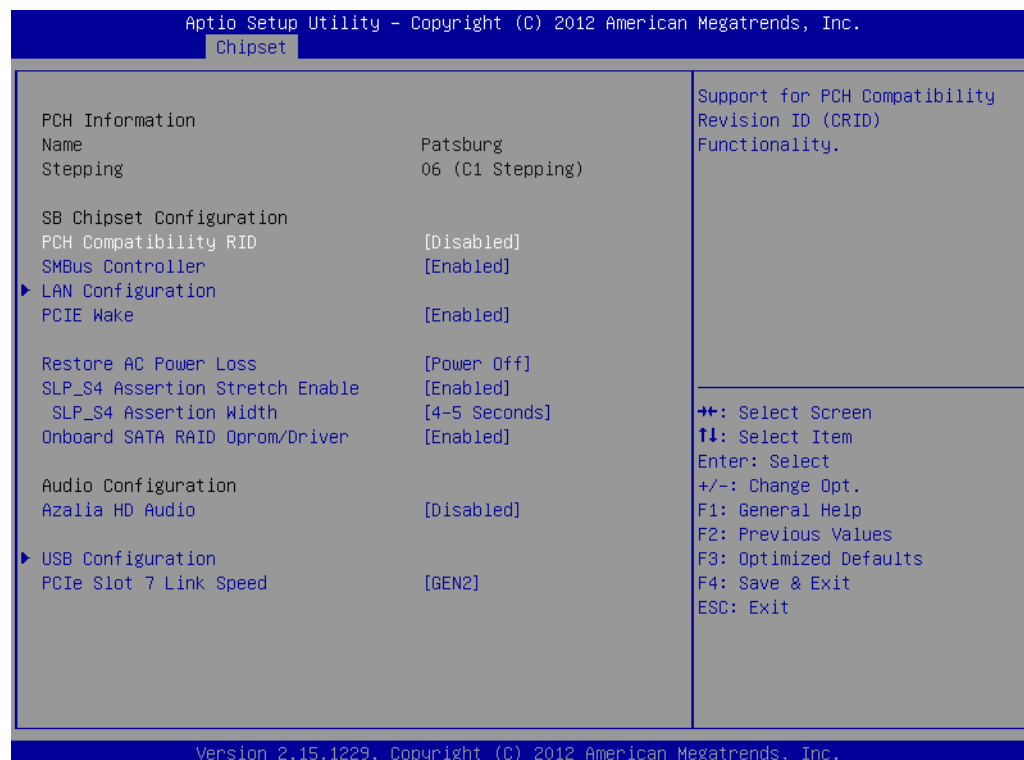

- **PCH Compatibility RID**
Enable/Disable PCH Compatibility Revision ID (CRID) Functionality.
- **SMBus Controller**
Enable/Disable SMBus controller.
- **PCIE Wake**
Enable or disable PCIE to wake the system from S5.
- **Restore AC Power Loss**
Specify what state to go to when power is re-applied after a power failure (G3 state).
- **SLP_S4 Assertion Stretch Enable**
Enable/Disable SLP_S4 Assertion Stretch function.
- **Onboard SATA RAID Oprom**
Enable/Disable onboard SATA RAID option rom if Launch Storage Oprom is enabled.
- **Azalia HD Audio**
Enable/Disable Azalia HD audio function.
- **PCIe Slot 7 Link Speed**
Select target link speed as Gen1, Gen2.

LAN Configuration

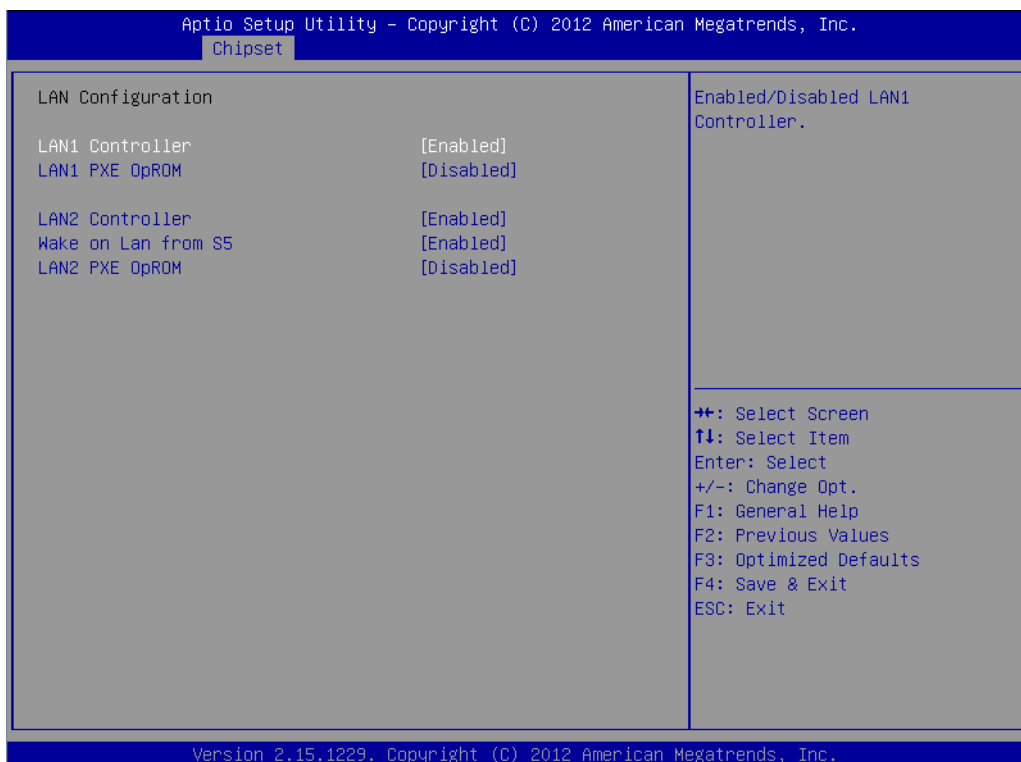

- **LAN1 Controller**
Enable/Disable Intel I210 Controller support.
- **LAN1 PXE OproM**
Enable/Disable Boot option for Intel I210 controller.
- **LAN2 Controller**
Enable/Disable Intel 82579LM Controller support.
- **LAN2 PXE OproM**
Enable/Disable Boot option for Intel 82579LM controller.

- **Wake on LAN From S5**

Enable/Disable Intel 82579LM controller wake up from S5 support.

USB Configuration

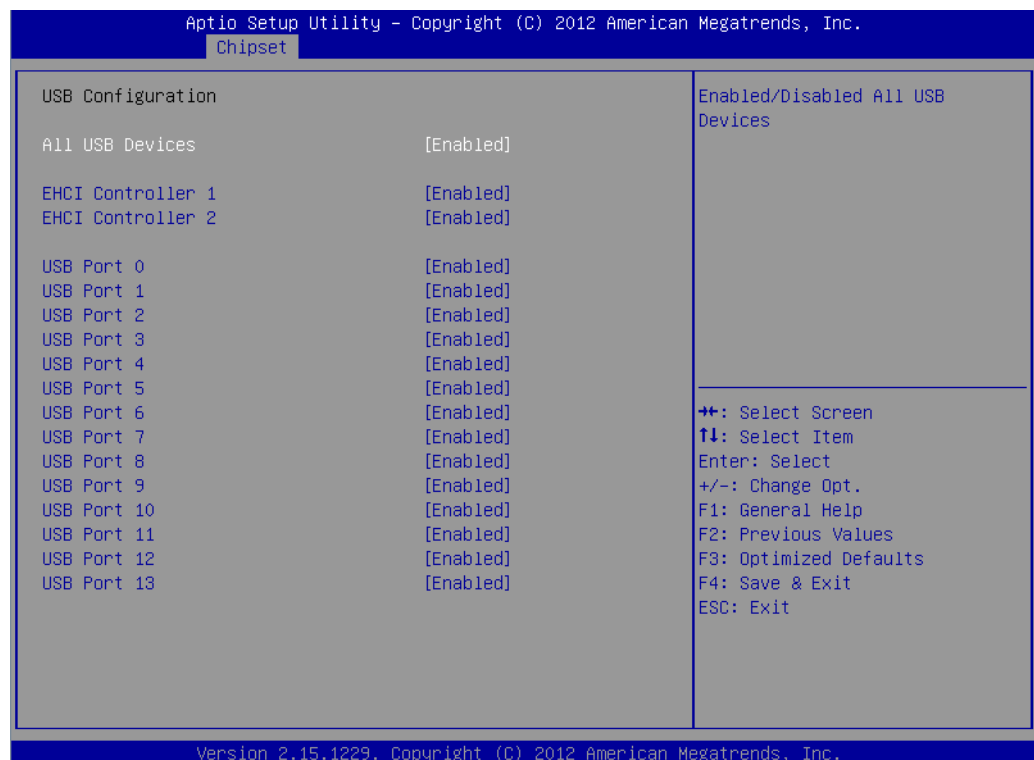

- **All USB Devices**

Enable/Disable all USB devices.

- **EHCI Controller 1**

Enable/Disable USB 2.0 (EHCI) support.

- **EHCI Controller 2**

Enable/Disable USB 2.0 (EHCI) support.

- **USB Port 0 ~ 13**

Enable/Disable USB 0 ~ 13 port.

3.2.3.3 ME Subsystem

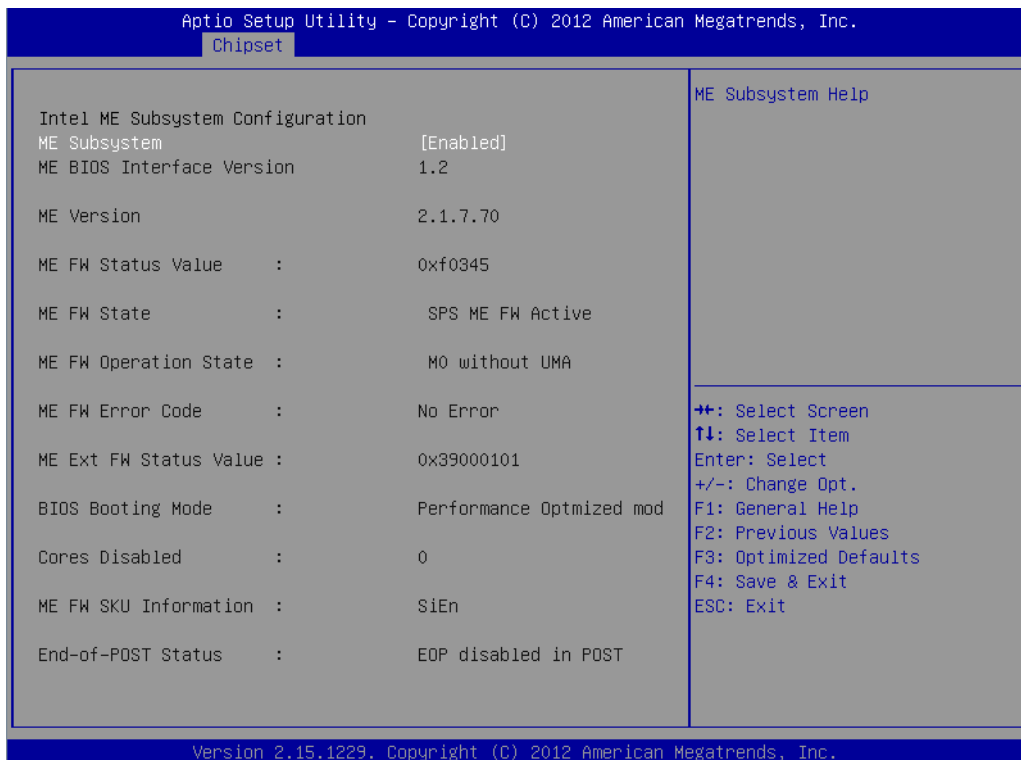

3.2.4 Server Management

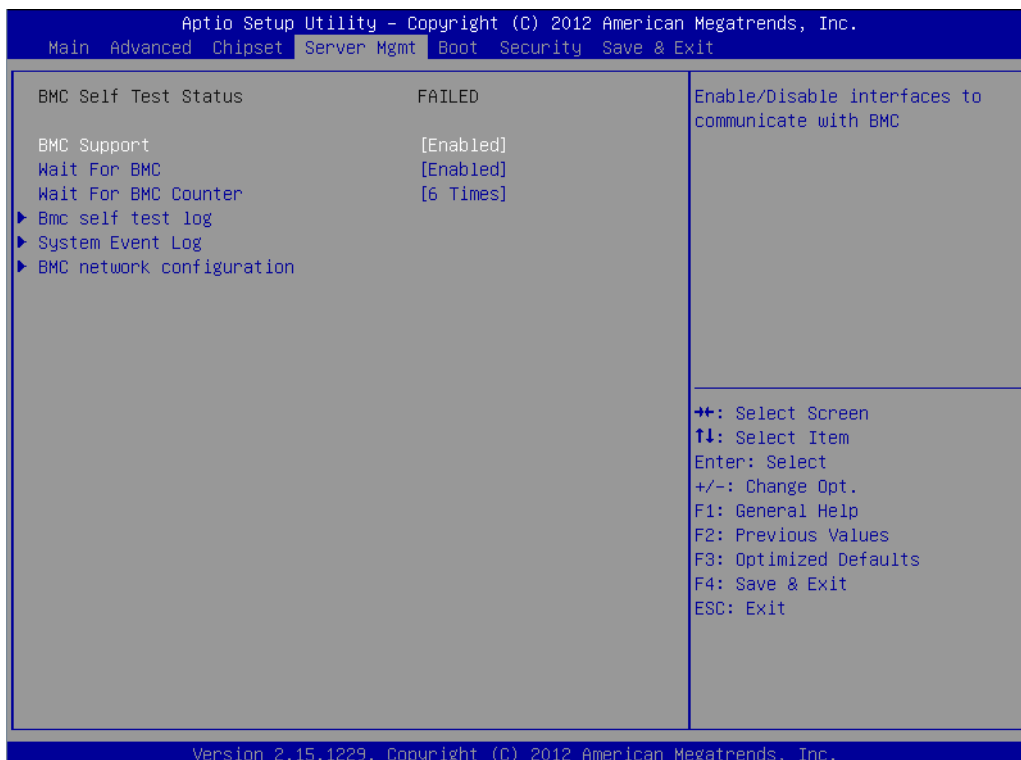

-
- **BMC Support**
Enable/Disable interfaces to communicate with BMC
 - **Wait for BMC**
If enabled, motherboard will wait 30 ~ 60 seconds until BMC module boots up completely. After that, the normal BIOS post screen will be displayed.
If disabled, motherboard will not wait for BMC module's response.
 - **Wait for BMC counter**
Wait for BMC counter for initialize host to BMC interfaces.
The MB beep per 5 seconds to check it.

3.2.4.1 **BMC Self Test Log**

- **Erase Log**
Erase log options.
- **When Log is Full**
Select the action to be taken when log is full.

3.2.4.2 **System Event Log**

- **SEL Components**
Enable/Disable all features of system event logging during boot.
- **Erase SEL**
Choose options for erasing SEL.
- **When SEL is Full**
Choose options for reactions to a full SEL.
- **Log EFI Status Codes**
Disable the logging of EFI status codes or log only error code or only progress code or both.

3.2.4.3 **BMC Network Configuration**

- **Configuration Address Source**
Select to configure LAN channel parameters statically or dynamically (by BMC).
Unspecified option will not modify any BMC network parameters during BIOS phase.

3.2.5 Boot

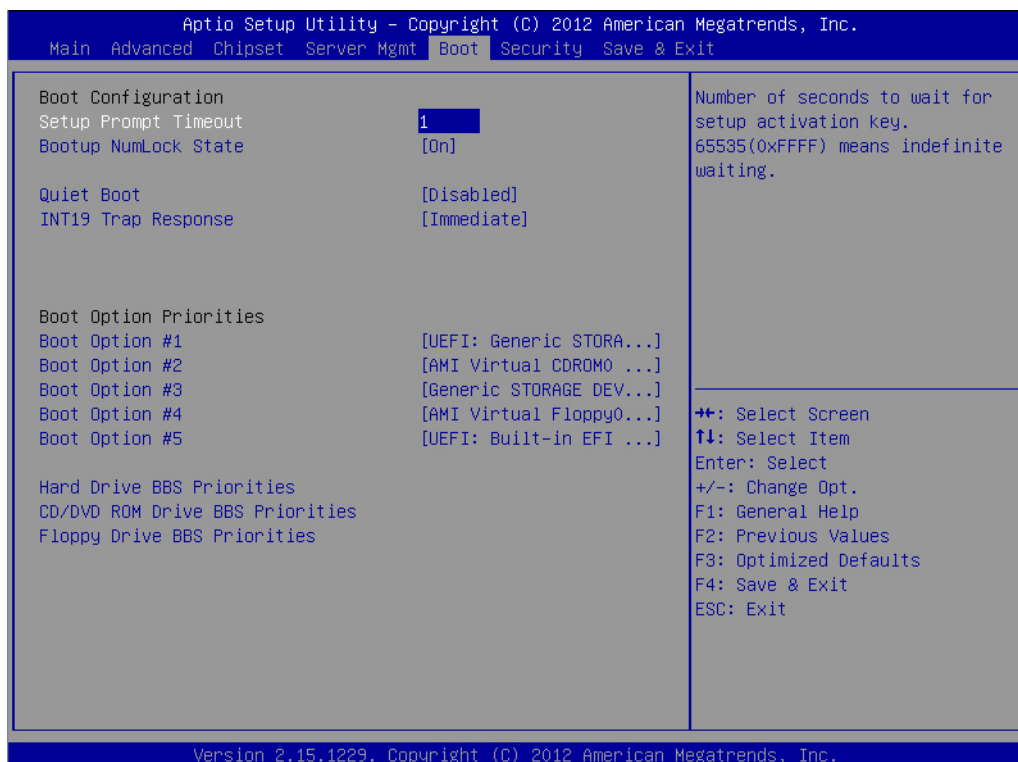

- **Setup Prompt Timeout**
Number of seconds to wait for setup activation key. 16 (0x10) means indefinite waiting.
- **Bootup NumLock State**
Select the keyboard NumLock state.
- **Quiet Boot**
Enable/Disable quiet boot option.
- **INT19 Trap Response**
BIOS reaction on INT19 trapping by option ROM:
 - Immediate - execute the trap right away.
 - Postponed - execute the trap during legacy boot.
- **Boot Option**
Sets the system boot priorities.

3.2.6 Security



3.2.7 Save & Exit

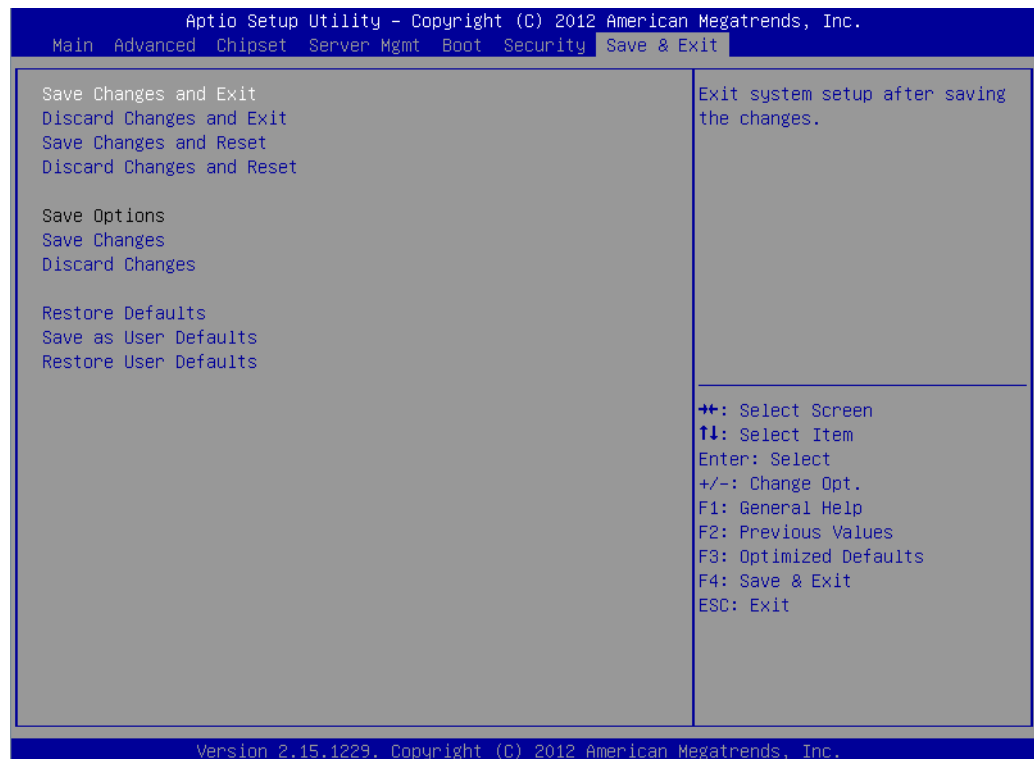

- **Save Changes and Exit**
Exit system setup after saving the changes
- **Discard Changes and Exit**
Exit system setup without saving any changes
- **Save Changes and Reset**
Reset the system after saving changes
- **Discard Changes and Reset**
Reset system setup without saving any changes
- **Save Changes**
Save changes done so far to any of the setup options
- **Discard Changes**
Discard changes done so far to any of the setup options
- **Restore Defaults**
Restore/Load default values for all the setup options
- **Save as User Defaults**
Save the changes done so far as user defaults
- **Restore User Defaults**
Restore the user default to all the setup options

Chapter 4

Chipset Software
Installation Utility

4.1 Before Beginning

To facilitate the installation of the enhanced display drivers and utility software, read the instructions in this chapter carefully. The drivers for the ASMB-822I are located on the software installation CD.

Before beginning, it is important to note that most display drivers need to have the relevant software application already installed on the system prior to installing the enhanced display drivers. In addition, many of the installation procedures assume that you are familiar with both the relevant software applications and operating system commands. Review the relevant operating system commands and the pertinent sections of your application software's user manual before performing the installation.

4.2 Introduction

4.2.1 Main Menu

The Intel Chipset Software Installation (CSI) utility installs the Windows INF files that outline to the operating system how the chipset components will be configured. This is needed for the proper functioning of the following features:

- Core PCI PnP services
- Serial ATA interface support
- USB 1.1/2.0 support (USB 2.0 driver needs to be installed separately for Windows 98)
- Identification of Intel chipset components in the Device Manager

Note! *The files on the software installation CD are compressed. Do not attempt to install the drivers by copying the files manually. You must use the supplied SETUP program to install the drivers.*



Note! *The chipset driver is used for the following versions of Windows, and it has to be installed before installing all the other drivers:*



Windows 8(RTM revision)	x86 & x64
Windows Server 2008 Enterprise Edition R2	x64
Windows Server 2008 Enterprise Edition	x86 & x64
Windows Server 2003 Enterprise Edition SP2	x86 & x64
Windows 7(Ultimate SP1)	x86 & x64
Windows Vista SP2	x86 & x64
Windows XP SP3 Professional*	x86 & x64
Windows XP Embedded SP3 (WES2009)	x86

Note! *It is necessary to update all the latest Microsoft hot fix files when using this OS.*



4.3 Windows XP / Windows 2003 / Windows 2008 / Windows 7 Driver Setup

1. Insert the driver CD into your system's CD-ROM drive. When the folder is displayed, move the mouse cursor over the folder "01_Intel INF". Find the executable in this folder, click to install the driver.

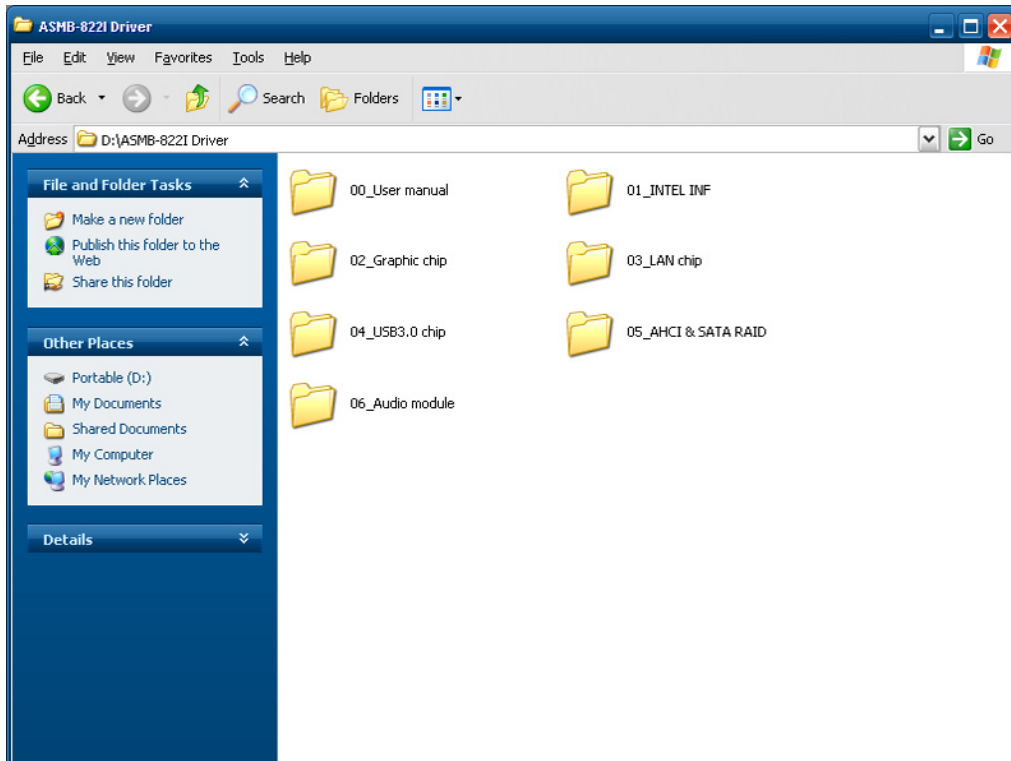

2. Click setup to execute program.

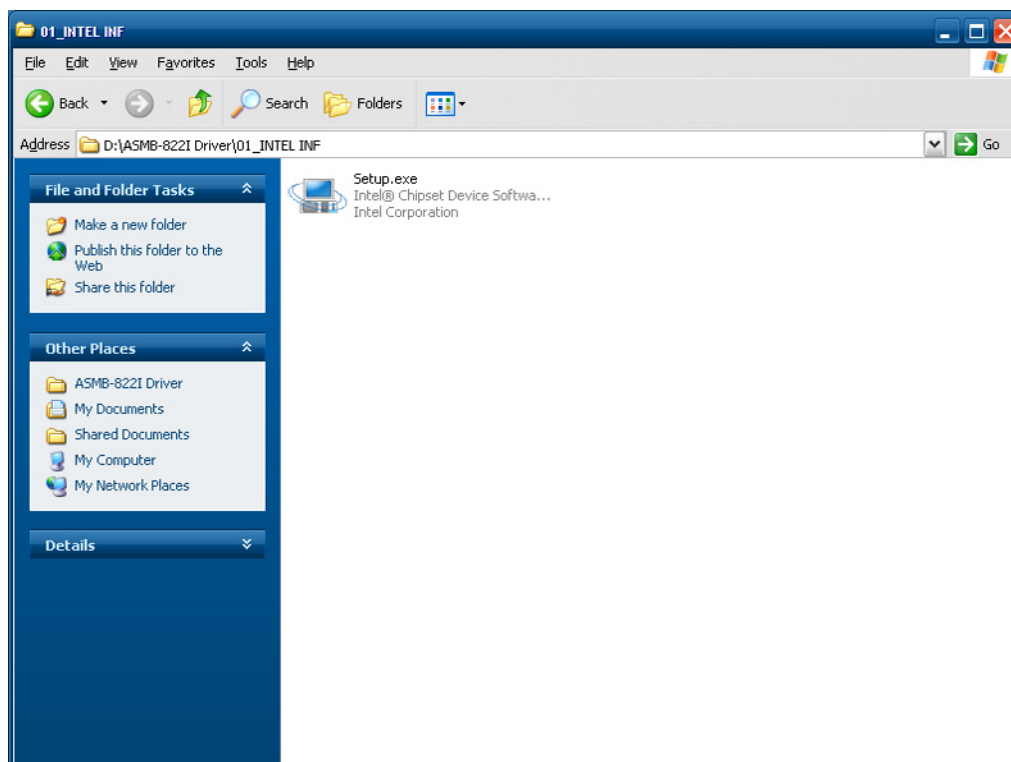

Chapter 5

VGA Setup

5.1 Introduction

Install the ASPEED VGA driver to enable this function, which includes the following features:

- 32-bit 2D graphics engine on board for normal use.
- 64-MB Ram for this chip, the highest resolution is 1920x1200.

5.2 Windows Series Driver Setup

Insert the driver CD into your system's CD-ROM drive. When the folder is displayed, navigate to the "02_Graphic chip" folder and click the executable file to complete the installation of the drivers for OS that you need.

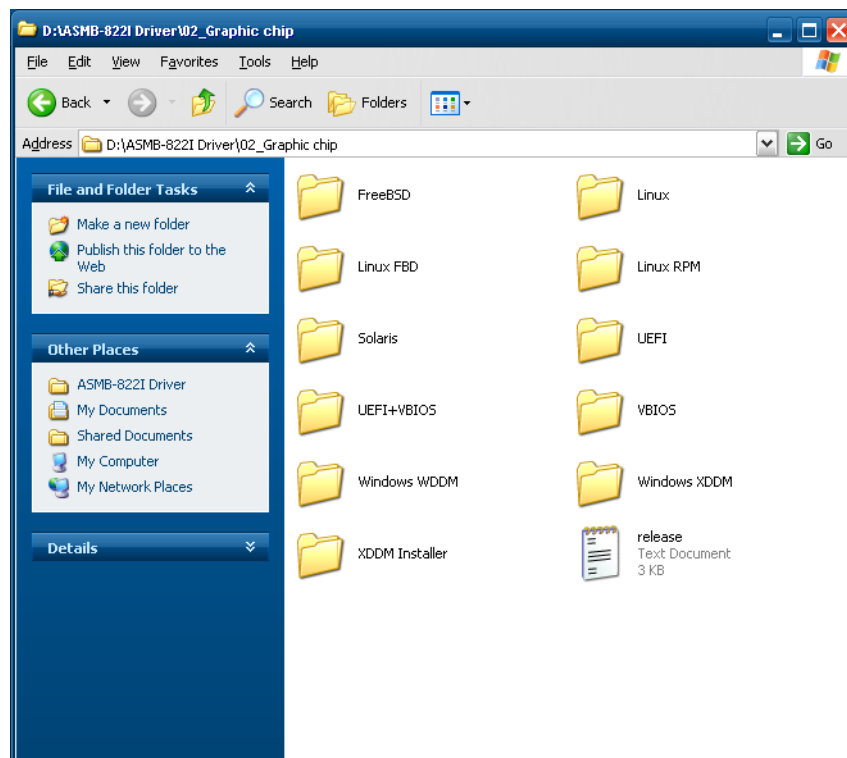

- Note!**
1. If ASMB-822I plug a additional graphic card for VGA output, please set this additional graphic card as "major output" under the "Display properties" of OS.
 2. Please use the driver file from "Windows WDDM" folder as first choice.

Chapter 6

LAN Configuration &
USB 3.0

6.1 LAN Configuration

6.1.1 Introduction

The ASMB-822I has two Gigabit Ethernet LAN connections via dedicated PCI Express x1 lanes: GbE LAN1 - Intel I210; GbE LAN2 - Intel 82579LM. They offer bandwidth of up to 500 MB/sec, eliminating the bottleneck of network data flow and incorporating Gigabit Ethernet at 1000 Mbps.

6.1.2 Features

- 10/100/1000Base-T Ethernet controller
- 10/100/1000Base-T triple-speed MAC
- Full duplex at 10, 100, or 1000 Mbps and half duplex at 10 or 100 Mbps
- Wake-on-LAN (WOL) support
- PCIe x1 host interface

6.1.3 Installation

The integrated Intel gigabit Ethernet controller supports all major network operating systems. However, the installation procedure varies with different operating systems. In the following sections, refer to the one that provides the driver setup procedure for the operating system you are using.

6.1.4 Windows Series Driver Setup (LAN)

1. Insert the driver CD into your system's CD-ROM drive. Select folder "03_Lan chip" then click the proper Lan driver for the OS.

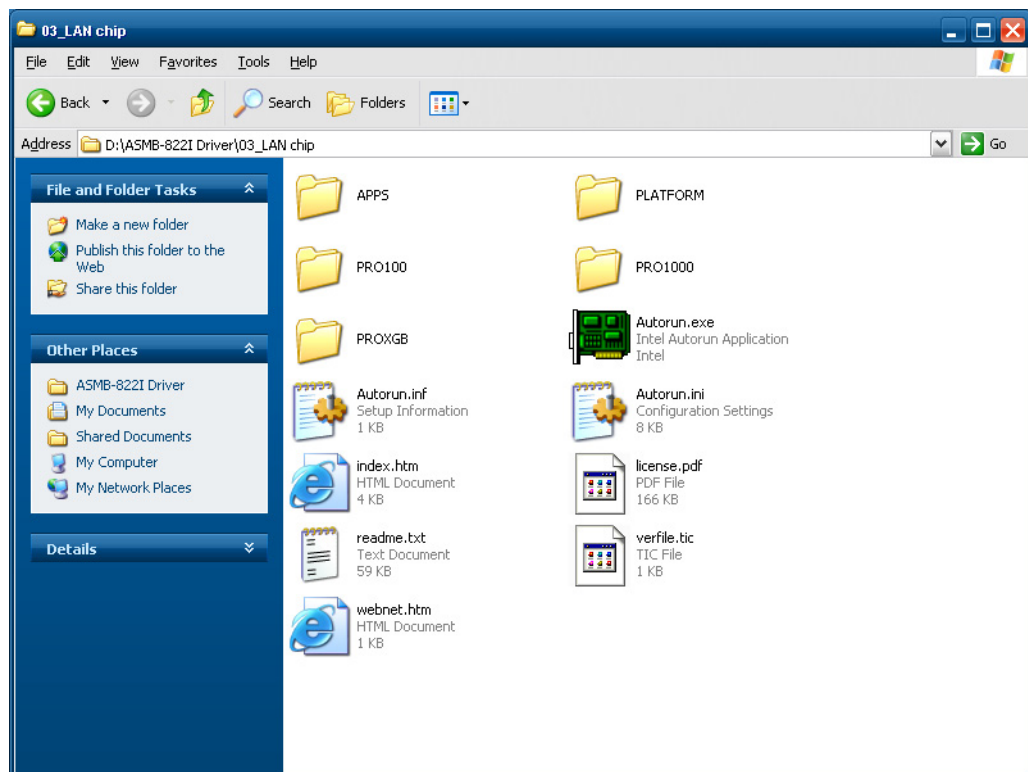

6.2 USB 3.0

6.2.1 Introduction

ASMB-822I offers two USB 3.0 ports in rear side. The USB 3.0 could provide the bandwidth up to 500MB/s to shorter the time for data transmission.

6.2.2 Windows series driver setup

Insert the driver CD into your system's CD-ROM drive. Select folder "04_USB3.0 chip" then click the proper ".exe" driver file for the installation.

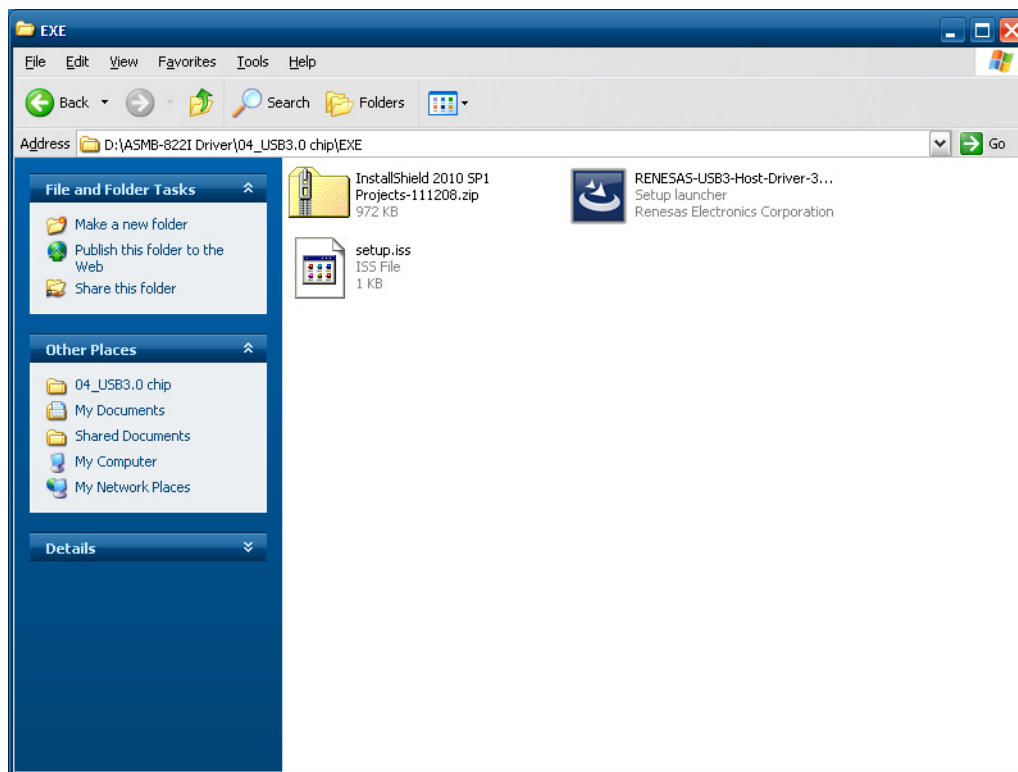

Appendix **A**

Programming the
Watchdog Timer

The ASMB-822I's watchdog timer can be used to monitor system software operation and take corrective action if the software fails to function within the programmed period. This section describes the operation of the watchdog timer and how to program it.

A.1 Watchdog Timer Overview

The watchdog timer is built in to the super I/O controller NCT6776F. It provides the following functions for user programming:

- Can be enabled and disabled by user program
- Timer can be set from 1 to 255 seconds or 1 to 255 minutes
- Generates an interrupt or resets signal if the software fails to reset the timer before time-out

A.2 Programming the Watchdog Timer

The I/O port address of the watchdog timer is 2E (hex) and 2F (hex). 2E (hex) is the address port. 2F (hex) is the data port. You must first write an address value into address port 2E (hex), and then write/read data to/from the assigned register through data port 2F (hex).

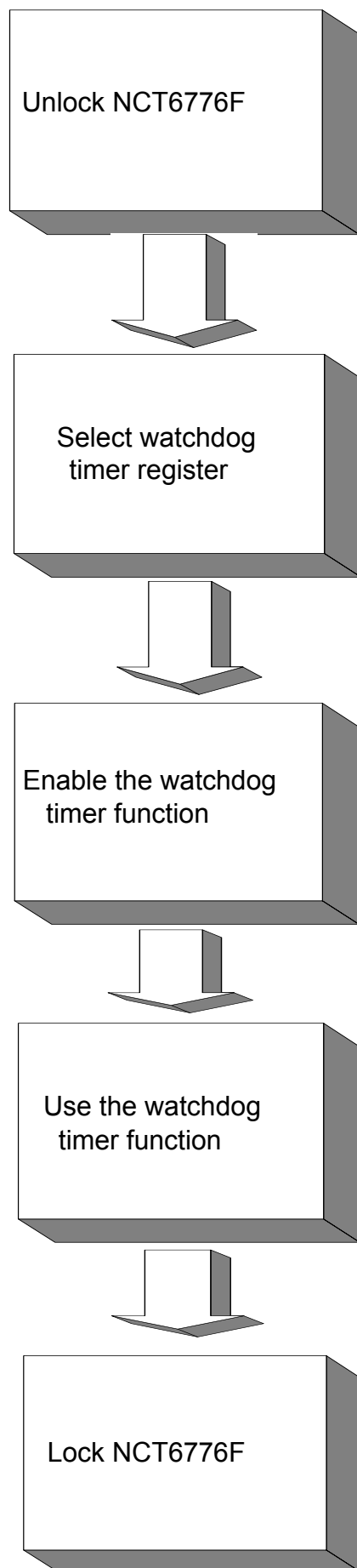

Table A.1: Watchdog Timer Registers

Address of register (2E)	Read/Write	Value (2F) & description
87 (hex)	-	Write this address to I/O address port 2E (hex) twice to unlock the NCT6776F
07 (hex)	write	Write 08 (hex) to select register of watchdog timer.
30 (hex)	write	Write 01 (hex) to enable the function of the watchdog timer. Disabled is set as default.
F5 (hex)	write	Set seconds or minutes as units for the timer. Write 0 to bit 3: set seconds as counting unit. [default]. Write 1 to bit 3: set minutes as counting unit. Write 1 to bit 4: Watchdog timer count mode is 1000 times faster. If bit 3 is 0, the count mode is 1/1000 seconds mode. If bit 3 is 1, the count mode is 1/1000 minutes mode.
F6 (hex)	write	0: stop timer [default] 01 ~ FF (hex): The amount of the count, in seconds or minutes, depends on the value set in register F5 (hex). This number decides how long the watchdog timer waits for strobe before generating an interrupt or reset signal. Writing a new value to this register can reset the timer to count with the new value.
F7 (hex)	read/write	Bit 6: Write 1 to enable keyboard to reset the timer, 0 to disable. [default] Bit 5: Write 1 to generate a timeout signal immediately and automatically return to 0. [default=0] Bit 4: Read status of watchdog timer, 1 means timer is "timeout".
AA (hex)	-	Write this address to I/O port 2E (hex) to lock NCT6776F.

A.2.1 Example Programs

Enable watchdog timer and set 10 seconds as the timeout interval

```

;-----
Mov dx,2eh ; Unlock NCT6776F
Mov al,87h
Out dx,al
Out dx,al
;-----
Mov al,07h ; Select registers of watchdog timer
Out dx,al
Inc dx
in al,dx
Or al,08h
Out dx,al
;-----
Dec dx; Enable the function of watchdog timer
Mov al,30h
Out dx,al
Inc dx
Mov al,01h
Out dx,al
;-----

```

```

Dec dx ; Set second as counting unit
Mov al,0f5h
Out dx,al
Inc dx
In al,dx
And al,not 08h
Out dx,al
;-----
Dec dx ; Set timeout interval as 10 seconds and start counting
Mov al,0f6h
Out dx,al
Inc dx
Mov al,10; 10 minutes
Out dx,al
;-----
Dec dx ; lock NCT6776F
Mov al,0aah
Out dx,al
Enable watchdog timer and set 5 minutes as the timeout interval
;-----
Mov dx,2eh ; unlock NCT6776F
Mov al,87h
Out dx,al
Out dx,al
;-----
Mov al,07h ; Select registers of watchdog timer
Out dx,al
Inc dx
In al,dx
Or al,08h
Out dx,al
;-----
Dec dx ; Enable the function of watchdog timer
Mov al,30h
Out dx,al
Inc dx
Mov al,01h
Out dx,al
;-----
Dec dx ; Set minute as counting unit
Mov al,0f5h
Out dx, al
Inc dx
In al,dx
Or al, 08h

```

```

Out dx,al
;-----
Dec dx ; Set timeout interval as 5 minutes and start counting
Mov al,0f6h
Out dx,al
Inc dx
Mov al,5; 5 minutes
Out dx,al
;-----
Dec dx ; lock NCT6776F
Mov al,0aah
Out dx,al
Enable watchdog timer to be reset by mouse
;-----
Mov dx,2eh ; unlock NCT6776F
Mov al,87h
Out dx,al
Out dx,al
;-----
Mov al,07h ; Select registers of watchdog timer
Out dx,al
Inc dx
Mov al,08h
Out dx,al
;-----
Dec dx ; Enable the function of watchdog timer
Mov al,30h
Out dx,al
Inc dx
In al,dx
Or al,01h
Out dx,al
;-----
Dec dx ; Enable watchdog timer to be reset by mouse
Mov al,0f7h
Out dx,al
Inc dx
In al,dx
Or al,80h
Out dx,al
;-----
Dec dx ; lock NCT6776F
Mov al,0aah
Out dx,al
Enable watchdog timer to be reset by keyboard

```



```

;-----
Mov dx,2eh ; unlock NCT6776F
Mov al,87h
Out dx,al
Out dx,al
;-----
Mov al,07h ; Select registers of watchdog timer
Out dx,al
Inc dx
Mov al,08h
Out dx,al
;-----
Dec dx ; Enable the function of watchdog timer
Mov al,30h
Out dx,al
Inc dx
Mov al,01h
Out dx,al
;-----
Dec dx ; Enable watchdog timer to be strobed reset by keyboard
Mov al,0f7h
Out dx,al
Inc dx
In al,dx
Or al,40h
Out dx,al
;-----
Dec dx ; lock NCT6776F
Mov al,0aah
Out dx,al
Generate a time-out signal without timer counting
;-----
Mov dx,2eh ; unlock NCT6776F
Mov al,87h
Out dx,al
Out dx,al
;-----
Mov al,07h ; Select registers of watchdog timer
Out dx,al
Inc dx
Mov al,08h
Out dx,al
;-----
Dec dx ; Enable the function of watchdog timer
Mov al,30h

```

```
Out dx,al
Inc dx
In al,dx
Or al,01h
Out dx,al
;-----
Dec dx ; Generate a time-out signal
Mov al,0f7h
Out dx,al ;Write 1 to bit 5 of F7 register
Inc dx
In al,dx
Or al,20h
Out dx,al
;-----
Dec dx ; lock NCT6776F
Mov al,0aah
Out dx,al
```

Appendix **B**

I/O Pin Assignments

B.1 USB Header (USB45, USB67, USB89)

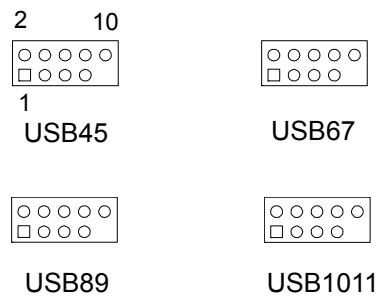

Table B.1: USB Header (USB45,USB67,USB89,USB1011)

Pin	Signal	Pin	Signal
1	USB_VCC5	2	USB_VCC5
3	USB_D-	4	USB_D-
5	USB_D+	6	USB_D+
7	GND	8	GND
9	Key	10	N/C

B.2 VGA Connector (VGA1)

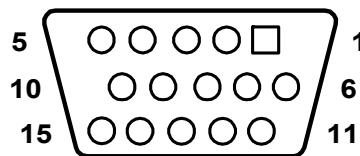

Table B.2: VGA Connector (VGA1)

Pin	Signal	Pin	Signal
1	RED	9	VCC
2	GREEN	10	GND
3	BLUE	11	N/C
4	N/C	12	SDT
5	GND	13	H-SYNC
6	GND	14	V-SYNC
7	GND	15	SCK
8	GND		

B.3 RS-232 Interface (COM2)

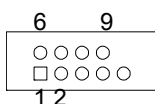

Table B.3: RS-232 Interface (COM2)

Pin	Signal
1	DCD
2	RXD
3	TXD
4	DTR
5	GND
6	DSR
7	RTS
8	CTS
9	RI

B.4 PS/2 Keyboard and Mouse Connector (KBMS1)



Table B.4: Keyboard and Mouse Connector (KBMS1)

Pin	Signal
1	KB DATA
2	N/C
3	GND
4	KB VCC
5	KB CLK
6	N/C
7	M_DATA
8	N/C
9	GND
10	M_VCC
11	M_CLK
12	N/C

B.5 External Keyboard Connector (KBMS2)

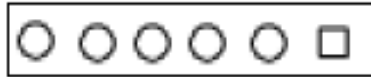

Table B.5: External Keyboard Connector (KBMS2)

Pin	Signal
1	KB CLK
2	KB DATA
3	MS DATA
4	GND
5	VCC
6	MS CLK

B.6 System Fan Power Connector (SYSFAN0~2)

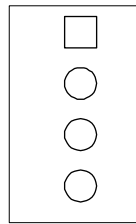

Table B.6: Fan Power Connector (SYSFAN0/SYSFAN1/SYSFAN2)

Pin	Signal
1	GND
2	+12 V
3	DETECT
4	PWM

B.7 Power LED (JFP1)

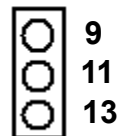

Table B.7: Power LED (JFP1)

Pin	Function
9	LED power (3.3 V)
11	NC
13	Ground

B.8 External Speaker Connector (JFP1)

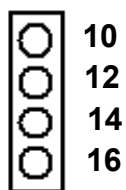

Table B.8: External Speaker Connector (JFP1)

Pin	Function
10	SPK_VCC
12	SPK_OBS
14	SPK_BUZ
16	SPK_OUT

B.9 Reset Connector (JFP1)

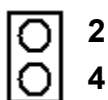

Table B.9: Reset Connector (JFP1)

Pin	Signal
2	RESET
4	GND

B.10 HDD LED Connector (JFP1)

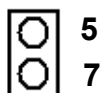

Table B.10: HDD LED Connector (JFP1)

Pin	Signal
5	HDD_LED+
7	HDD_LED-

B.11 ATX Soft Power Switch (JFP1)

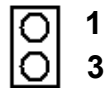
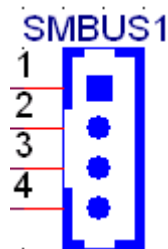

Table B.11: ATX Soft Power Switch (JFP1)

Pin	Signal
1	PWR-BTN
3	GND

B.12 Front panel SMBus Connector (SMBUS1)



1	+3.3V_AUX
2	SMB_SCL_FRU
3	SMB_SDA_FRU
4	GND

B.13 USB/LAN Ports (LAN1_USB01 and LAN2_USB23)

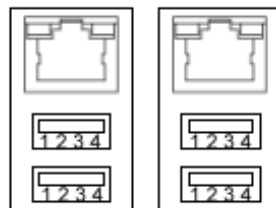

LAN1_USB01 LAN2_USB23

Table B.12: USB Port

Pin	Signal	Pin	Signal
1	VCC_DUAL	3	Data0+
2	Data0-	4	GND

Table B.13: Giga LAN 10/100/1000 Base-T RJ-45 Port

Pin	Signal	Pin	Signal
1	MID0+	5	MID2+
2	MID0-	6	MID2+
3	MID1+	7	MID3+
4	MID1-	8	MID3+

B.14 Audio Connector (AUDIO1)

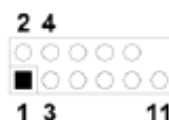
**Table B.14: Front Panel Audio Connector (FPAUD1)**

Pin	Signal	Pin	Signal
1	ACZ_VCC	2	GND
3	ACZ_SYNC	4	ACZ_BITCLK
5	ACZ_SDOUT	6	ACZ_SDIN0
7	ACZ_SDIN1	8	ACZ_RST
9	ACZ_12V	10	GND
11	GND	12	N/C

B.15 8-pin Alarm Board Connector (VOLT1)

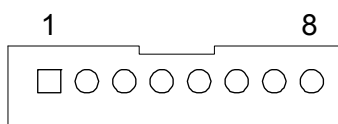
**Table B.15: 8-pin Alarm Board Connector (VOLT1)**

Pin	Signal	Pin	Signal
1	5VSB	5	+5V
2	GND	6	+3.3V
3	GND	7	-12V
4	-5V	8	+12V

B.16 Case Open Connector (JFP1)

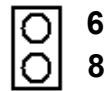

Table B.16: Case Open Connector (JFP1)

Pin	Signal
6	CASEOP
8	GND

B.17 Front Panel LAN LED Connector (LANLED1)

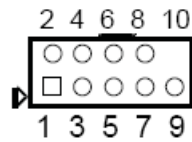

Table B.17: LAN LED Connector (LANLED1)

Pin	Signal	Pin	Signal
1	LAN1/3_LED0_ACT	2	LAN2/4_LED1_ACT
3	VCC3_LAN1LED	4	VCC3_LAN2LED
5	LAN1/3_LED1_1000M	6	LAN2/4_LED2_1000
7	LAN1/3_LED2_100M	8	LAN2/4_LED0_100
9	VCC3	10	N/C

ADVANTECH

Enabling an Intelligent Planet

www.advantech.com

Please verify specifications before quoting. This guide is intended for reference purpOS only.

All product specifications are subject to change without notice.

No part of this publication may be reproduced in any form or by any means, electronic, photocopying, recording or otherwise, without prior written permission of the publisher.

All brand and product names are trademarks or registered trademarks of their respective companies.

© Advantech Co., Ltd. 2012