

Cree® PLCC4 1 in 1 SMD LED CLM4B-BKW/GKW



PRODUCT DESCRIPTION

SMD LEDs is packaged in the industry standard package. These LEDs have high reliability performance and are designed to work under a wide range of environmental conditions.

This high reliability feature makes them ideally suited to be used under architectural lighting application conditions.

Its wide viewing angle makes these LEDs ideally suited for channel letter, or architectural lighting applications. The flat top emitting surface makes it easy for these LEDs to mate with light pipes.

FEATURES

- Size (mm): 3.2 x 2.7
- Color and Typical Dominant Wavelength:
Blue (470nm)
Green (527nm)
- Luminous Intensity (mcd)
CLM4B-BKW: (450 - 900)
CLM4B-GKW: (2240 - 4500)
- Lead-Free
- RoHS Compliant

APPLICATIONS

- Channel Letter
- Architectural Lighting

ABSOLUTE MAXIMUM RATINGS ($T_A = 25^\circ\text{C}$)

Items	Color	Symbol	Absolute Maximum Rating	Unit
Forward Current	Blue/Green	I_F	35	mA
Peak Forward Current ^{Note}	Blue/Green	I_{FP}	100	mA
Reverse Voltage	Blue/Green	V_R	5	V
Power Dissipation	Blue	P_D	133	mW
	Green	P_D	129.5	mW
Operation Temperature	Blue/Green	T_{opr}	-40 ~ +100	$^\circ\text{C}$
Storage Temperature	Blue/Green	T_{stg}	-40 ~ +100	$^\circ\text{C}$
Junction Temperature	Blue/Green	T_J	110	$^\circ\text{C}$
Junction/Ambient	Blue	R_{THJA}	350	$^\circ\text{C}/\text{W}$
	Green	R_{THJA}	450	$^\circ\text{C}/\text{W}$
Junction/Solder Point	Blue	R_{THJS}	200	$^\circ\text{C}/\text{W}$
	Green	R_{THJS}	300	$^\circ\text{C}/\text{W}$

Note: Pulse width ≤ 0.1 msec, duty $\leq 1/10$.

TYPICAL ELECTRICAL & OPTICAL CHARACTERISTICS ($T_A = 25^\circ\text{C}$)

Characteristics	Color	Symbol	Condition	Unit	Minimum	Typical	Maximum
Forward Voltage	Blue	V_F	$I_F = 30$ mA	V		3.1	3.8
	Green	V_F	$I_F = 30$ mA	V		3.0	3.7
Reverse Current	Blue/Green	I_R	$V_R = 5$ V	μA			10
Dominant Wavelength	Blue	λ_D	$I_F = 30$ mA	nm	460	470	475
	Green	λ_D	$I_F = 30$ mA	nm	520	527	535
Luminous Intensity	Blue	I_V	$I_F = 30$ mA	mcd	450	650	
	Green	I_V	$I_F = 30$ mA	mcd	2240	3200	

INTENSITY BIN LIMIT ($I_F = 30 \text{ mA}$)

Blue (CLM4B-BKW)

Bin Code	Min.(mcd)	Max.(mcd)
Ua	450	560
Ub	560	710
Va	710	900

Green (CLM4B-GKW)

Bin Code	Min.(mcd)	Max.(mcd)
Xb	2240	2800
Ya	2800	3550
Yb	3550	4500

Tolerance of measurement of luminous intensity is $\pm 10\%$.

COLOR BIN LIMIT ($I_F = 30 \text{ mA}$)

Blue (CLM4B-BKW)

Bin Code	Min.(nm)	Max.(nm)
B3	460	465
B23	462.5	467.5
B4	465	470
B45	467.5	472.5
B5	470	475

Green (CLM4B-GKW)

Bin Code	Min.(nm)	Max.(nm)
G7	520	525
G23	522.5	527.5
G8	525	530
G45	527.5	532.5
G9	530	535

Tolerance of measurement of dominant wavelength is $\pm 1 \text{ nm}$.

ORDER CODE TABLE*

Color	Kit Number	Luminous Intensity (mcd)		Dominant Wavelength			
		Min.	Max.	Color Bin	Min.(nm)	Color Bin	Max.(nm)
Blue	CLM4B-BKW-CUaVa353	450	900	B3	460	B5	475
Blue	CLM4B-BKW-CUbVa453	560	900	B4	465	B5	475

Color	Kit Number	Luminous Intensity (mcd)		Dominant Wavelength			
		Min.	Max.	Color Bin	Min.(nm)	Color Bin	Max.(nm)
Green	CLM4B-GKW-CXbYb793	2240	4500	G7	520	G9	535
Green	CLM4B-GKW-CYaYb793	2800	4500	G7	520	G9	535

Notes:

1. The above kit numbers represent order codes that include multiple intensity-bin and color-bin codes. Only one intensity-bin code and one color-bin code will be shipped on each bulk. Single intensity-bin code and single color-bin codes will not be orderable.
2. Please refer to the "Cree LED Lamp Reliability Test Standards" document for reliability test conditions.
3. Please refer to the "Cree LED Lamp Soldering & Handling" document for information about how to use this LED product safely.

GRAPHS

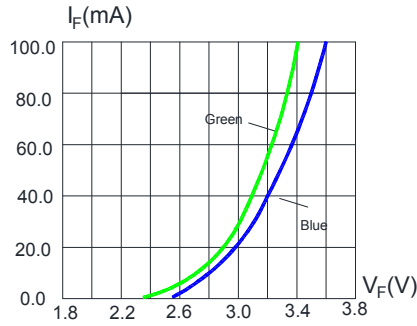

FIG.1 FORWARD CURRENT VS. FORWARD VOLTAGE.

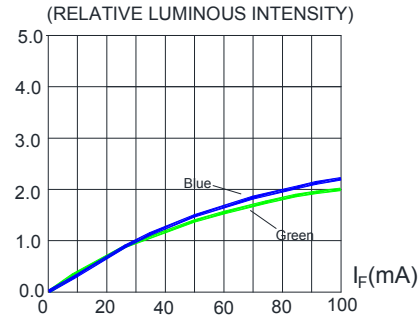

FIG.2 RELATIVE LUMINOUS INTENSITY VS. FORWARD CURRENT

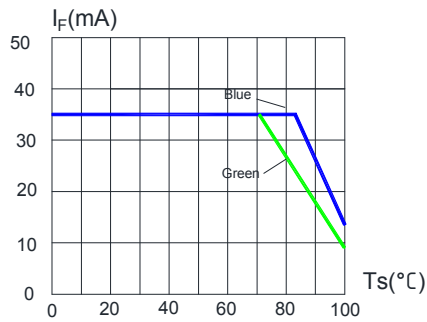

FIG.3 BLUE&GREEN MAXIMUM FORWARD DC CURRENT VS SOLDER TEMPERATURE ($T_{jmax}=110^{\circ}C$)

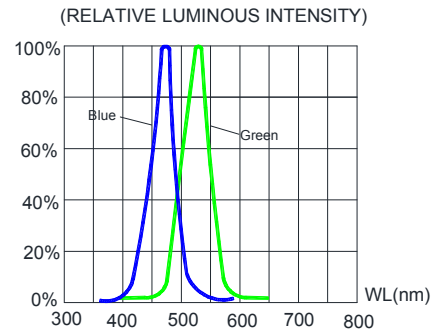

FIG.4 RELATIVE LUMINOUS INTENSITY VS. WAVELENGTH.

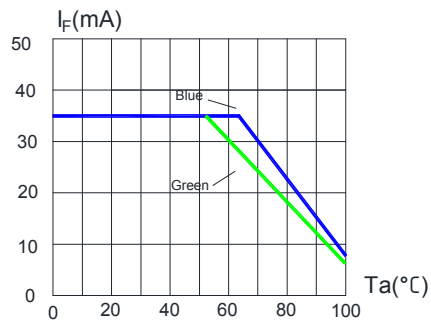

FIG.5 BLUE&GREEN MAXIMUM FORWARD DC CURRENT VS AMBIENT TEMPERATURE ($T_{jmax}=110^{\circ}C$)

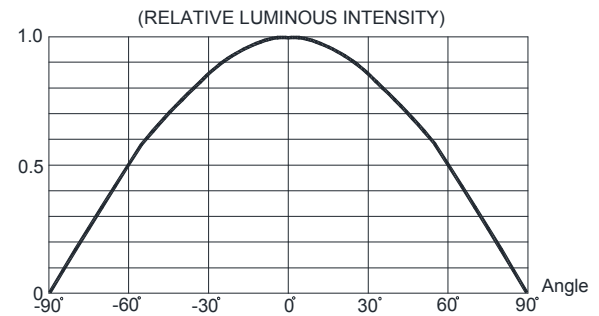
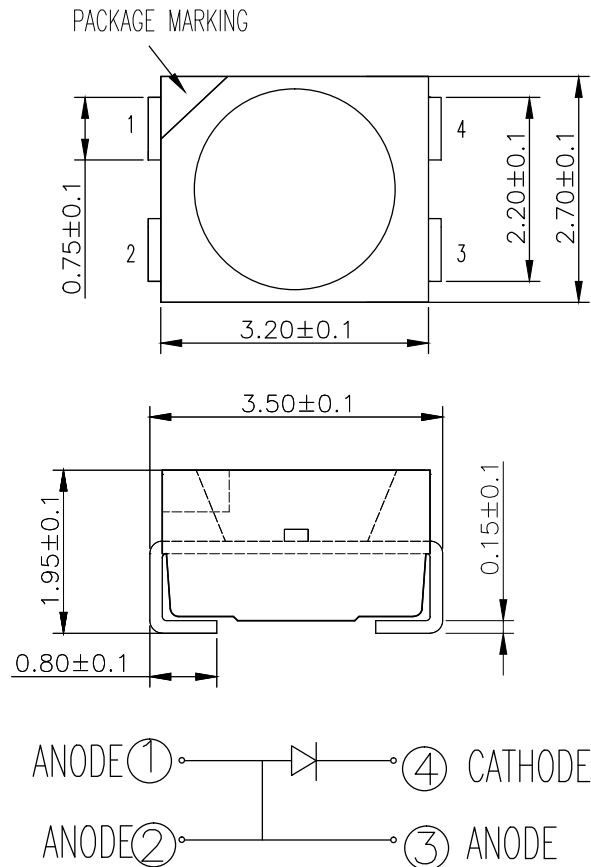

FIG.6 FAR FIELD PATTERN

The above data are collected from statistical figures that do not necessarily correspond to the actual parameters of each single LED. Hence, these data will be changed without further notice.

MECHANICAL DIMENSIONS

All dimensions are in mm.



NOTES

RoHS Compliance

The levels of environmentally sensitive, persistent biologically toxic (PBT), persistent organic pollutants (POP), or otherwise restricted materials in this product are below the maximum concentration values (also referred to as the threshold limits) permitted for such substances, or are used in an exempted application, in accordance with EU Directive 2002/95/EC on the restriction of the use of certain hazardous substances in electrical and electronic equipment (RoHS), as amended through April 21, 2006.

Vision Advisory Claim

Users should be cautioned not to stare at the light of this LED product. The bright light can damage the eye.

KIT NUMBER SYSTEM

Cree LED lamps are tested and sorted into performance bins. A bin is specified by ranges of color, forward voltage, and brightness. Sorted LEDs are packaged for shipping in various convenient options. Please refer to the "Cree LED Lamp Packaging Standard" document for more information about shipping and packaging options.

Cree LEDs are sold by order codes in combinations of bins called kits. Order codes are configured in the following manner:



PACKAGING

- The boxes are not water resistant and they must be kept away from water and moisture.
- The LEDs are packed in cardboard boxes after packaging in normal or anti-electrostatic bags.
- Cardboard boxes will be used to protect the LEDs from mechanical shocks during transportation.
- The reel pack is applied in SMD LED.
- Max 2000 pcs per reel.

