

User Guide for
FEBFL7733A_L51U030A

High PF, Low THD, Wide Input Voltage
Range Flyback LED Driver with Analog
Dimming Function for 30 W LED Lamp

Featured Fairchild Product:
FL7733A

***Direct questions or comments
about this evaluation board to:
“Worldwide Direct Support”***

Fairchild Semiconductor.com



Table of Contents

1. Introduction	3
1.1. General Description of FL7733A	3
1.2. Controller Features.....	3
1.3. Controller Internal Block Diagram	4
2. Evaluation Board Specifications	5
3. Evaluation Board Photographs	6
4. Evaluation Board Printed Circuit Board (PCB)	7
5. Evaluation Board Schematic	8
6. Evaluation Board Bill of Materials	9
7. Transformer Design.....	11
8. Evaluation Board Performance	12
8.1. Startup.....	13
8.2. Operation Waveforms.....	14
8.3. Constant-Current Regulation	16
8.4. Short- / Open-LED Protections.....	17
8.5. Analog Dimming	19
8.6. Efficiency.....	21
8.7. Power Factor (PF) & Total Harmonic Distortion (THD)	23
8.8. Harmonics	24
8.9. Operating Temperature	26
8.10. Electromagnetic Interference (EMI).....	27
9. Revision History.....	28



This user guide supports the evaluation kit for the FL7733A. It should be used in conjunction with the FL7733A datasheet as well as Fairchild's application notes and technical support team. Please visit Fairchild's website at www.fairchildsemi.com.

1. Introduction

This document describes LED driver designed with flyback converter using the FL7733A Primary-Side Regulation (PSR) single-stage controller. The input voltage range is $90 V_{RMS} \sim 300 V_{RMS}$ and there is one DC output with a constant current of 0.58 A at 52 V. This document contains a general description of the FL7733A, the power supply solution specification, schematic, bill of materials, and typical operating characteristics with analog dimming function.

1.1. General Description of FL7733A

The FL7733A is an active Power Factor Correction (PFC) controller for use in single-stage flyback topology or buck-boost topology. Primary-side regulation and single-stage topology minimize cost by reducing external components such as the input bulk capacitor and secondary side feedback circuitry. To improve power factor and Total Harmonic Distortion (THD), constant on-time control is utilized with an internal error amplifier and a low bandwidth compensator. Precise constant-current control provides accurate output current, independent of input voltage and output voltage. Operating frequency is proportionally changed by the output voltage to guarantee Discontinuous Current Mode (DCM) operation, resulting in high efficiency and simple designs. The FL7733A also provides open-LED, short-LED, and over-temperature protection functions.

1.2. Controller Features

High Performance

- $< \pm 3\%$ Total Constant Current Tolerance Over All Conditions
 - $< \pm 1\%$ Over Universal Line Voltage Variation
 - $< \pm 1\%$ from 50% to 100% Load Voltage Variation
 - $< \pm 1\%$ with $\pm 20\%$ Magnetizing Inductance Variation
- Primary-Side Regulation (PSR) Control for Cost-Effective Solution without Requiring Input Bulk Capacitor and Secondary Feedback Circuitry
- Application Input Voltage Range: $80 V_{AC} - 308 V_{AC}$
- High PF and Low THD Over Universal Line Input Range
- Fast < 200 ms Startup (at $90 V_{AC}$) using Internal High-Voltage Startup with VDD Regulation
- Adaptive Feedback Loop Control for Startup without Overshoot

High Reliability

- LED Short / Open Protection
- Output Diode Short Protection
- Sensing Resistor Short / Open Protection
- V_{DD} Over-Voltage Protection (OVP)
- V_{DD} Under-Voltage Lockout (UVLO)
- Over-Temperature Protection (OTP)
- All Protections by Auto Restart
- Cycle-by-Cycle Current Limit
- Application Voltage Range: $80 V_{AC} \sim 308 V_{AC}$

1.3. Controller Internal Block Diagram

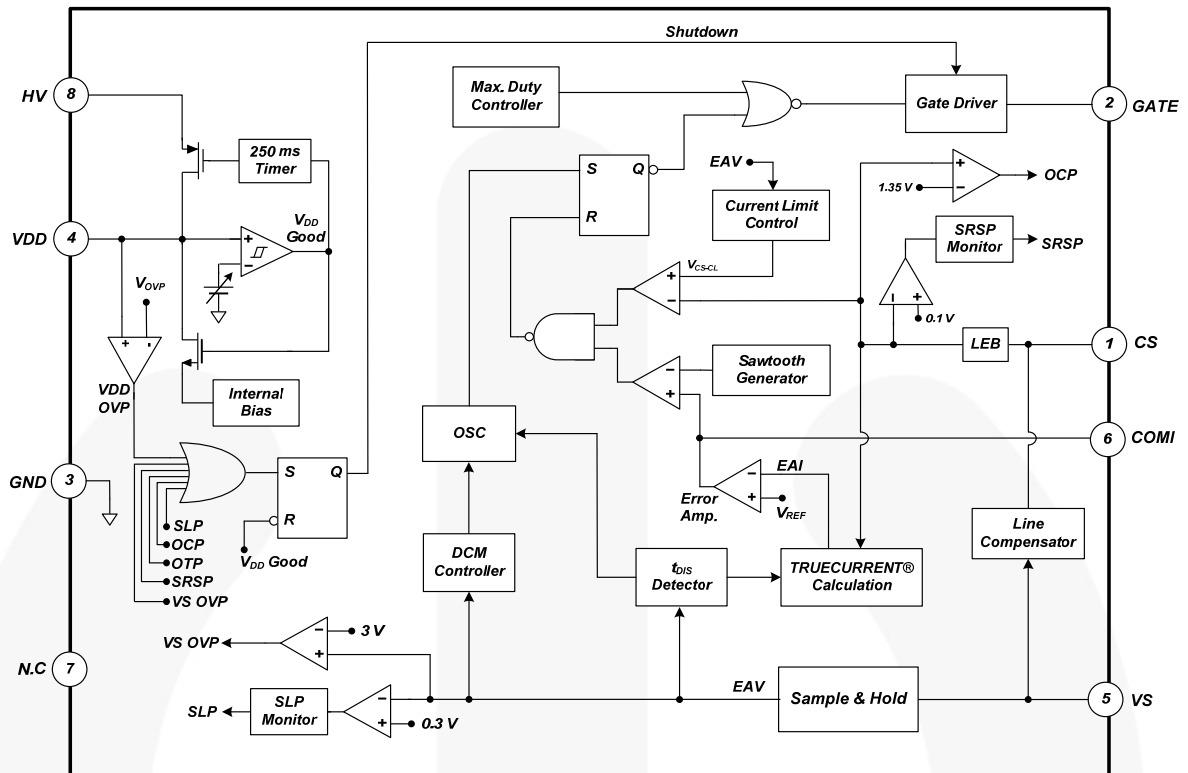

Figure 1. Block Diagram of the FL7733A



2. Evaluation Board Specifications

Table 1. Specifications for LED Lighting Load

Description		Symbol	Value	Comments
Input	Voltage	$V_{IN.MIN}$	90 V _{AC}	Minimum AC Line Input Voltage
		$V_{IN.MAX}$	305 V _{AC}	Maximum AC Line Input Voltage
		$V_{IN.NOMINAL}$	120 V / 230 V	Nominal AC Line Input Voltage
	Frequency	f_{IN}	60 Hz / 50 Hz	AC Line Frequency
Output	Voltage	$V_{OUT.MIN}$	25 V	Minimum Output Voltage
		$V_{OUT.MAX}$	55 V	Maximum Output Voltage
		$V_{OUT.NOMINAL}$	52 V	Nominal Output Voltage
	Current	$I_{OUT.NOMINAL}$	0.58 A	Nominal Output Current
		Max. CC Tolerance	< ±0.43%	Line Input Voltage Change: 90~300 V _{AC}
Efficiency		$Eff_{90 VAC}$	89.46%	Efficiency at 90 V _{AC} Input Voltage
		$Eff_{120 VAC}$	90.44%	Efficiency at 120 V _{AC} Input Voltage
		$Eff_{140 VAC}$	90.75%	Efficiency at 140 V _{AC} Input Voltage
		$Eff_{180 VAC}$	91.01%	Efficiency at 180 V _{AC} Input Voltage
		$Eff_{230 VAC}$	90.88%	Efficiency at 230 V _{AC} Input Voltage
		$Eff_{300 VAC}$	90.27%	Efficiency at 300 V _{AC} Input Voltage
PF / THD		PF / THD _{90VAC}	0.995 / 5.12%	PF/THD at 90 V _{AC} Input Voltage
		PF / THD _{120VAC}	0.992 / 2.32%	PF/THD at 120 V _{AC} Input Voltage
		PF / THD _{140VAC}	0.987 / 2.12%	PF/THD at 140 V _{AC} Input Voltage
		PF / THD _{180VAC}	0.976 / 2.58%	PF/THD at 180 V _{AC} Input Voltage
		PF / THD _{230VAC}	0.946 / 3.41%	PF/THD at 230 V _{AC} Input Voltage
		PF / THD _{300VAC}	0.874 / 5.93%	PF/THD at 300 V _{AC} Input Voltage
Max. Temperature Open-Frame (T _A = 25°C)	FL7733A	T _{FL7733A}	65.0°C	FL7733A Temperature
	MOSFET	T _{MOSFET}	75.4°C	Main MOSFET Temperature
	Rectifier	T _{Rectifier}	76.0°C	Secondary Diode Temperature
	Transformer	T _{TRANS}	67.2°C	Transformer Temperature

All data of the evaluation board measured with the board was enclosed in a case and external temperature around T_A=25°C.

3. Evaluation Board Photographs

Dimensions: 155 mm (L) x 28 mm (W) x 25 mm (H)



Figure 2. Top View

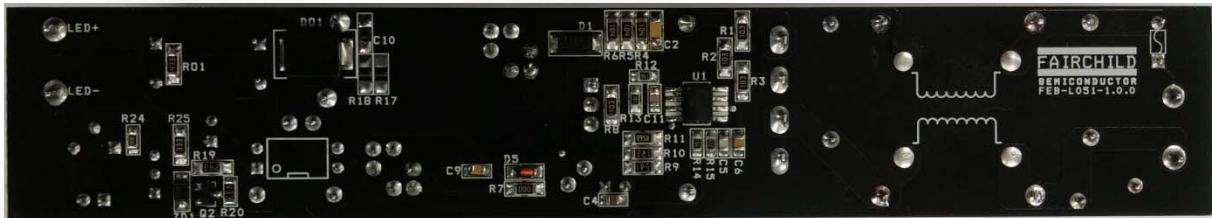

Figure 3. Bottom View



Figure 4. Side View

4. Evaluation Board Printed Circuit Board (PCB)

Unit: mm

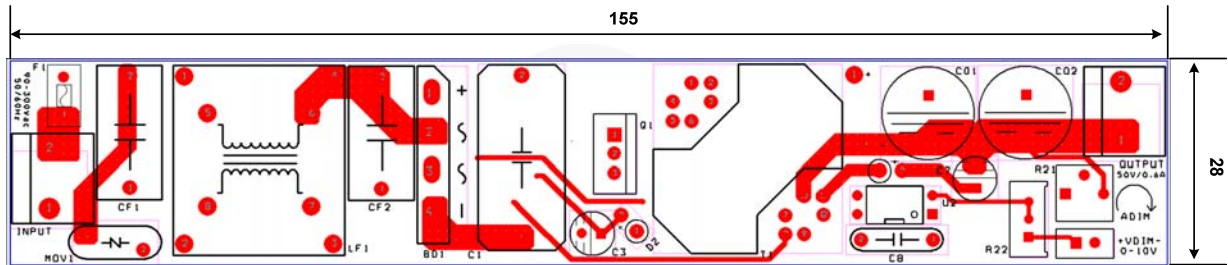

Figure 5. Top Pattern

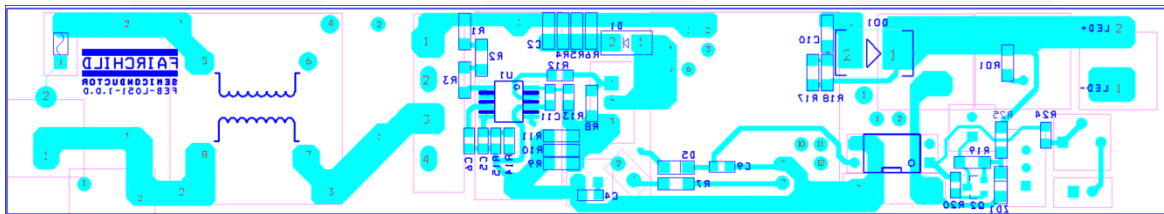

Figure 6. Bottom Pattern

5. Evaluation Board Schematic

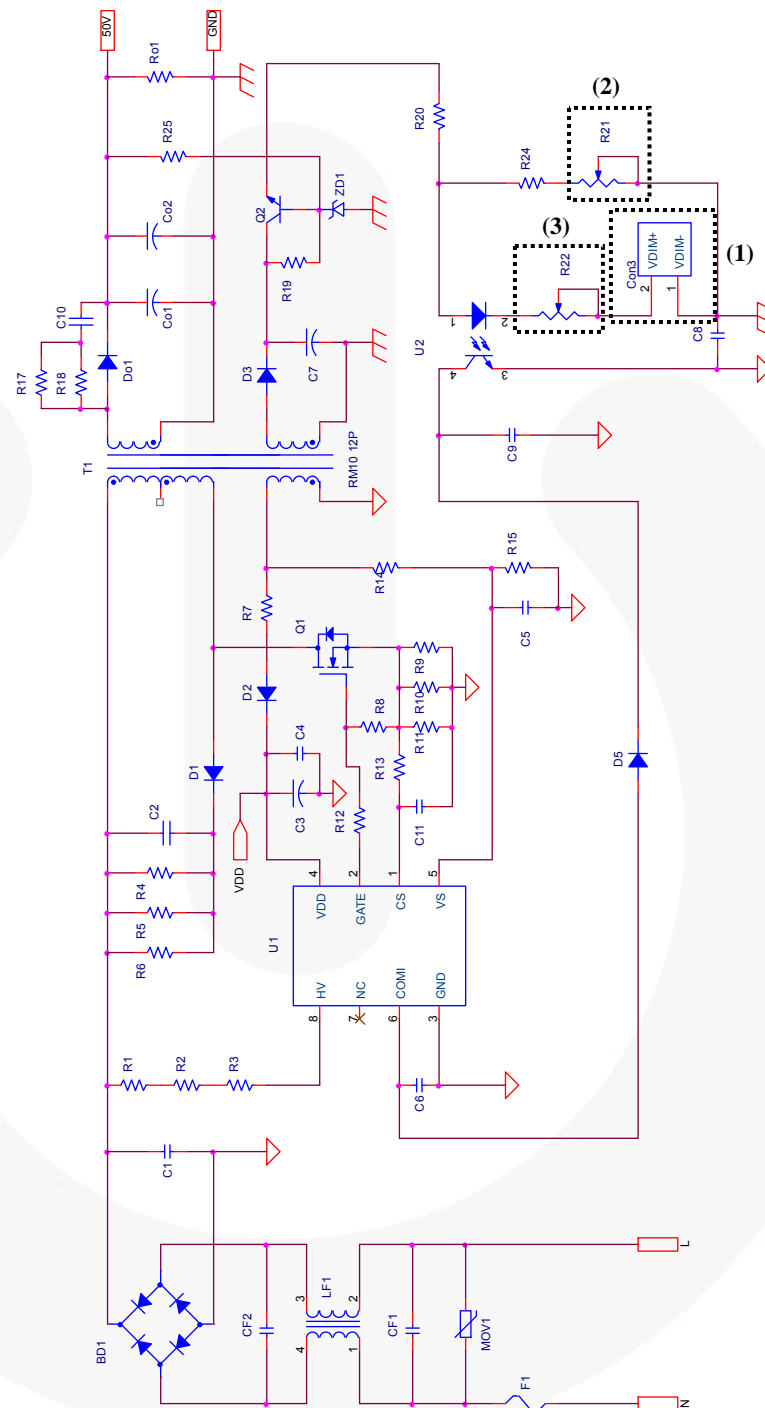

Figure 7. Schematic

Notes:

1. Dimming with A-DIM voltage: 0 to 10 V analog dimming signal should be input to Con 3.
2. Dimming with Variable Resistor [R21]: Please short Con 3's pin 1 to pin 2 with jumper wire.
3. Minimum current set: The current setting must be above 10% of nominal current level of this board to avoid triggering SRSP.



6. Evaluation Board Bill of Materials

Item No.	Part Reference	Part Number	Qty.	Description	Manufacturer
1	BD1	GBJ206	1	2 A / 600 V, Bridge Diode	KD
2	CF1	B32922D3334K	1	330 nF / 310 V _{AC} , X-Capacitor	Carli
3	CF2	B32922C3104K	1	100 nF / 310 V _{AC} , X-Capacitor	Carli
4	Co1, Co2	KMG 470 μ F / 63 V	2	470 μ F / 63 V, Electrolytic Capacitor	Smayoung
5	C1	MPE 630 V 154K	1	150 nF / 630 V, MPE Film Capacitor	Sungho
6	C2	C1206C103KDRACTU	1	10 nF / 630 V, SMD Capacitor 1206	Kemet
7	C3	KMG 10 μ F / 35 V	1	10 μ F / 35 V, Electrolytic Capacitor	Smayoung
8	C4	C0805C104K5RACTU	1	100 nF / 50 V, SMD Capacitor 2012	Kemet
9	C5	C0805C519C3GACTU	1	5.1 pF / 25 V, SMD Capacitor 2012	Kemet
10	C6	C0805C225K4RACTU	1	2.2 μ F / 16 V, SMD Capacitor 2012	Kemet
11	C7	KMG 10 μ F / 50 V	1	10 μ F / 50 V, Electrolytic Capacitor	Smayoung
12	C8	SCFz2E472M10BW	1	4.7 nF / 250 V, Y-Capacitor	Samwha
13	C9	C0805C102K5RACTU	1	1.0 nF / 25 V, SMD Capacitor 2012	Kemet
14	C10	NC			
15	C11	C0805C101K5GALTU	1	100 pF / 50 V, SMD Capacitor 2012	Kemet
16	Do1	ES3J	1	600 V/3 A, Fast Rectifier	Fairchild Semiconductor
17	D1	RS1M	1	1000 V/1 A, Ultra-Fast Recovery Diode	Fairchild Semiconductor
18	D2, D3	1N4003	2	200 V/1 A, General Purpose Rectifier	Fairchild Semiconductor
19	D5	LL4148	1	Small Signal Diode	Fairchild Semiconductor
20	U2	FOD817A	1	OPTOCOUPLER 4-Pin	Fairchild Semiconductor
21	F1	SS-5-2A	1	250 V / 2 A, Fuse	Bussmann
22	LF1	B82733F	1	40 mH Common Inductor	EPCOS
23	MOV1	SVC561D-10A	1	Metal Oxide Varistor	Samwha
24	Q1	FCPF850N80Z	1	800 V / 850 m Ω , N-Channel MOSFET	Fairchild Semiconductor
25	Q2	MMBT2222AT	1	NPN General Purpose Amplifier	Fairchild Semiconductor
26	Ro1	RC1206JR-0747KL	1	47 k Ω , SMD Resistor 1206	Yageo
27	R1, R2, R3, R8	RC1206JR-0710KL	4	10 k Ω , SMD Resistor 1206	Yageo
29	R4, R5, R6	RC1206JR-07100KL	3	100 k Ω , SMD Resistor 1206	Yageo



Item No.	Part Reference	Part Number	Qty.	Description	Manufacturer
30	R7	RC1206JR-0710R0L	1	0 Ω , SMD Resistor 1206	Yageo
31	R9	RC1206JR-071R5L	1	1.5 Ω , SMD Resistor 1206	Yageo
32	R10	RC1206JR-071R2L	1	1.2 Ω , SMD Resistor 1206	Yageo
33	R11	RL1206JR-070R56L	1	0.56 Ω , SMD Resistor 1206	Yageo
34	R12	RC0805JR-0715RL	1	15 Ω , SMD Resistor 0805	Yageo
35	R13	RC0805JR-07390RL	1	390 Ω , SMD Resistor 0805	Yageo
36	R14	RC0805JR-07150KL	1	150 k Ω , SMD Resistor 0805	Yageo
37	R15	RC0805JR-0722KL	1	22 k Ω , SMD Resistor 0805	Yageo
38	R17, R18	NC	2		
39	R19	RC1206JR-0724KL	1	24 k Ω , SMD Resistor 1206	Yageo
40	R20	RC1206JR-0743KL	1	43 k Ω , SMD Resistor 1206	Yageo
41	R21	3299W-1-104LF	1	100 k Ω , 0.5 W, Trimmer Resistor	Bourns Inc.
42	R22	GF063, 50k	1	50 k Ω , 0.5 W, Trimmer Resistor	Tocos
43	R24	RC0805JR-0710R0L	1	0 Ω , SMD Resistor 0805	Yageo
44	R25	RC1206JR-0733KL	1	33 k Ω , SMD Resistor 1206	Yageo
45	T1	RM10	1	RM10 Core, 12-Pin Transformer	TDK
46	U1	FL7733A	1	Main PSR Controller	Fairchild Semiconductor
47	CN1, CN2	Connector	2	I / O Connector	
48	CN3	Connector	1	2.54 mm Pin Header 2-Pin	
49	Jumper	Jumper	1	2.54 mm Pitch Jumper Connector	
50	ZD1	MM5Z10V	1	10 V Zener Diode	Fairchild Semiconductor

7. Transformer Design

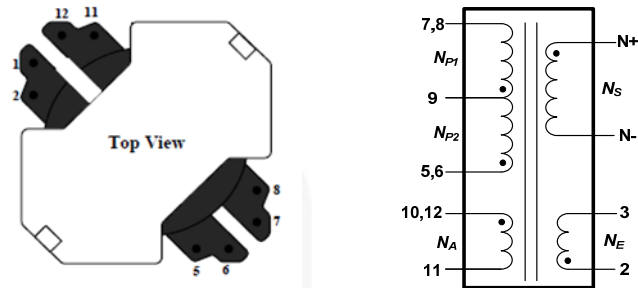

Figure 8. Transformer RM10's Bobbin Structure and Pin Configuration

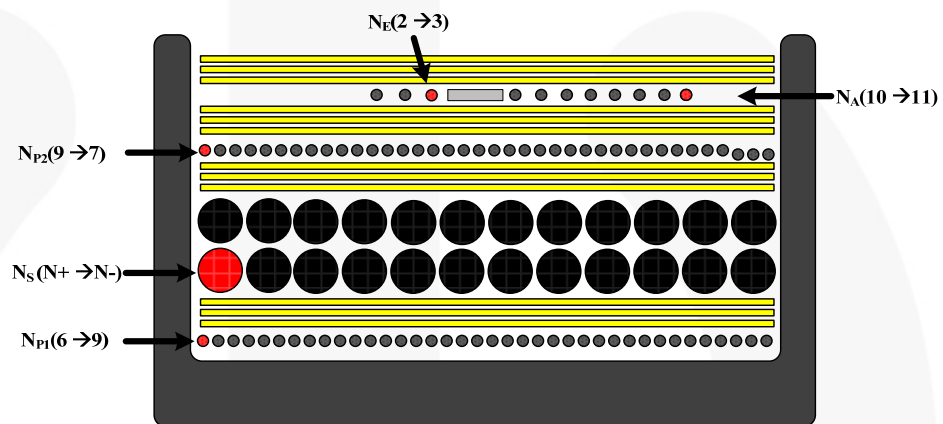

Figure 9. Transformer Winding Structure

Table 2. Winding Specifications

No	Winding	Pin(S → F)	Wire	Turns	Winding Method
1	NP1	6 → 9	0.45φ	18 Ts	Solenoid Winding
2	Insulation : Polyester Tape t = 0.025mm, 3Layers				
3	NS	N+ → N-	0.65φ [TIW]	22 Ts	Solenoid Winding
4	Insulation : Polyester Tape t = 0.025 mm, 3Layers				
5	NP2	9 → 7	0.45φ	15 Ts	Solenoid Winding
6	Insulation : Polyester Tape t = 0.025 mm, 3Layers				
7	NA	10 → 11	0.25φ	9 Ts	Solenoid Winding
	NE	2 → 3	0.20φ [TIW]	3 Ts	Solenoid Winding
8	Insulation: Polyester Tape t = 0.025 mm, 3-Layer				

Table 3. Electrical Characteristics

	Pin	Specifications	Remark
Inductance	6 – 7	280 μH ±10%	60 kHz, 1 V
Leakage	6 – 7	5 μH	60 kHz, 1 V, Short All Output Pins

8. Evaluation Board Performance

Table 4. Test Condition & Equipment List

Ambient Temperature	$T_A = 25\text{ }^\circ\text{C}$
Test Equipment	AC Power Source: PCR500L by Kikusui Power Analyzer: PZ4000000 by Yokogawa Electronic Load: PLZ303WH by KIKUSUI Multi Meter: 2002 by KEITHLEY, 45 by FLUKE Oscilloscope: 104Xi by LeCroy Thermometer: Thermal CAM SC640 by FLIR SYSTEMS LED: EHP-AX08EL/GT01H-P03 (3W) by Everlight

8.1. Startup

Figure 10 and Figure 11 show the overall startup performance at rated output load. The output load current starts flowing after about 0.2 s for input voltage 90 V_{AC} and 0.12 s for 300 V_{AC} condition upon AC input power switch turns on; CH1: V_{DD} (10 V / div), CH2: V_{IN} (200 V / div), CH3: V_{LED} (20 V / div), CH4: I_{LED} (500 mA / div), Time Scale: (200 ms / div), Load: 16 series-LEDs.

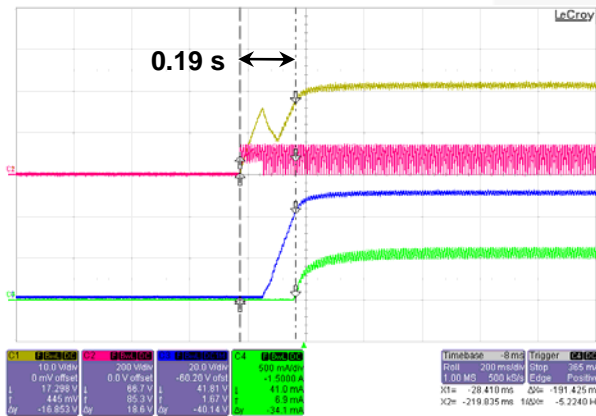

Figure 10. V_{IN} = 90 V_{AC} / 60 Hz

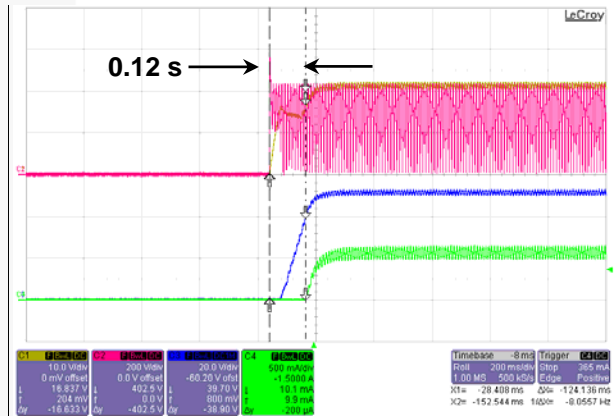

Figure 11. V_{IN} = 300 V_{AC} / 50 Hz

8.2. Operation Waveforms

Figure 12 to Figure 15 show AC input and output waveforms at rated output load.
 CH1: I_{IN} (500 mA / div), CH2: V_{IN} (200 V / div), CH3: V_{LED} (20 V / div), CH4: I_{LED} (500 mA / div), Time Scale: (5 ms / div), Load: 16 series-LEDs.

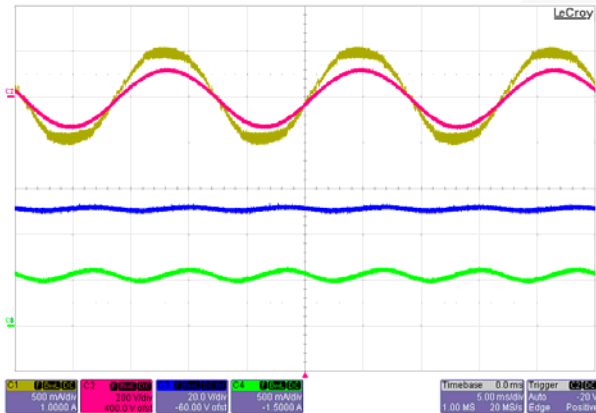

Figure 12. $V_{IN} = 90 V_{AC} / 60 Hz$

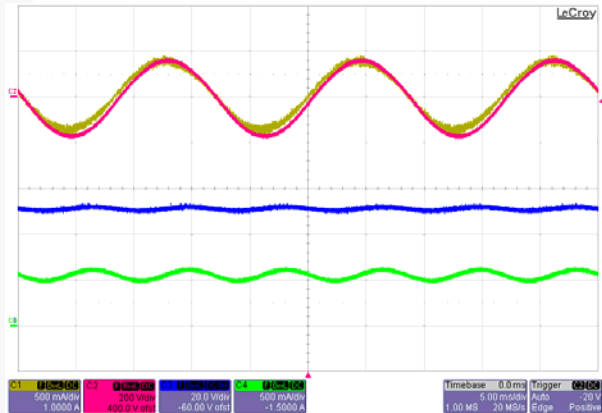

Figure 13. $V_{IN} = 120 V_{AC} / 60 Hz$

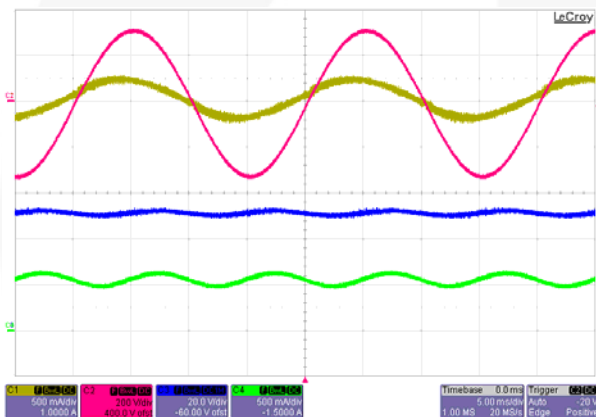

Figure 14. $V_{IN} = 230 V_{AC} / 50 Hz$

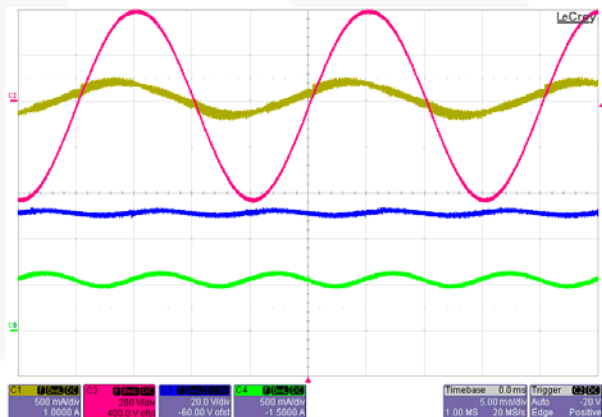

Figure 15. $V_{IN} = 300 V_{AC} / 50 Hz$

Figure 16 to Figure 19 show key waveforms of single-stage flyback converter operation for line voltage at rated output load. CH1: I_{DS} (1.00 A / div), CH2: V_{DS} (200 V / div), CH3: $V_{SEC-Diode}$ (200 V / div), CH4: $I_{SEC-Diode}$ (2.00 A / div), Load: 16 series-LEDs.

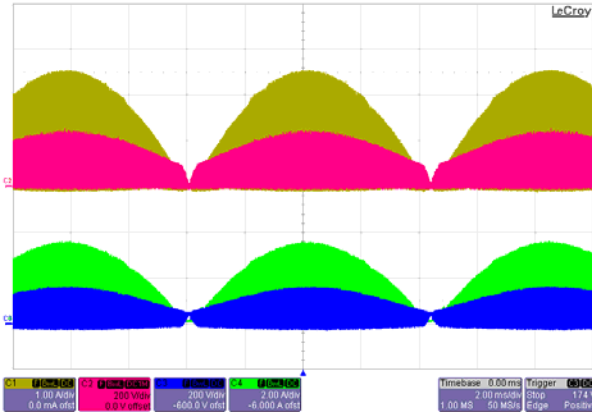

Figure 16. $V_{IN} = 90 V_{AC} / 60 \text{ Hz}$, [2.0 ms / div]

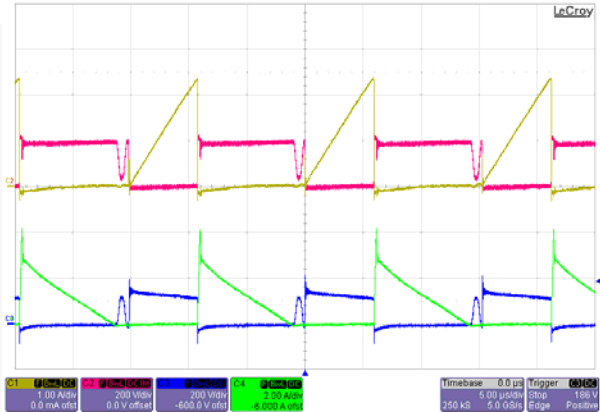

Figure 17. $V_{IN} = 90 V_{AC} / 60 \text{ Hz}$, [5.0 μs / div]

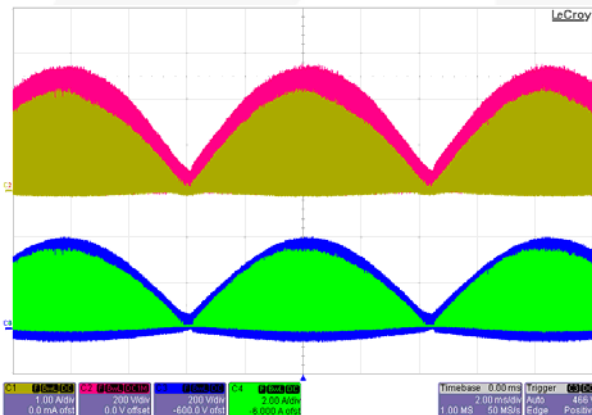

Figure 18. $V_{IN} = 300 V_{AC} / 60 \text{ Hz}$, [2.0 ms / div]

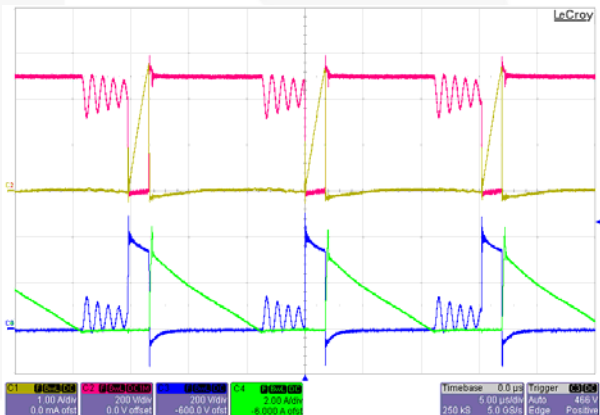

Figure 19. $V_{IN} = 300 V_{AC} / 60 \text{ Hz}$, [5.0 μs / div]

8.3. Constant-Current Regulation

The maximum output current deviation for wide output voltage ranges from 25 V to 55 V is less than $\pm 0.61\%$ at each line voltage. Line regulation at the output voltage (52 V) is also less than $\pm 0.43\%$ as shown Figure 20. The results were measured with E-load [CR Mode].

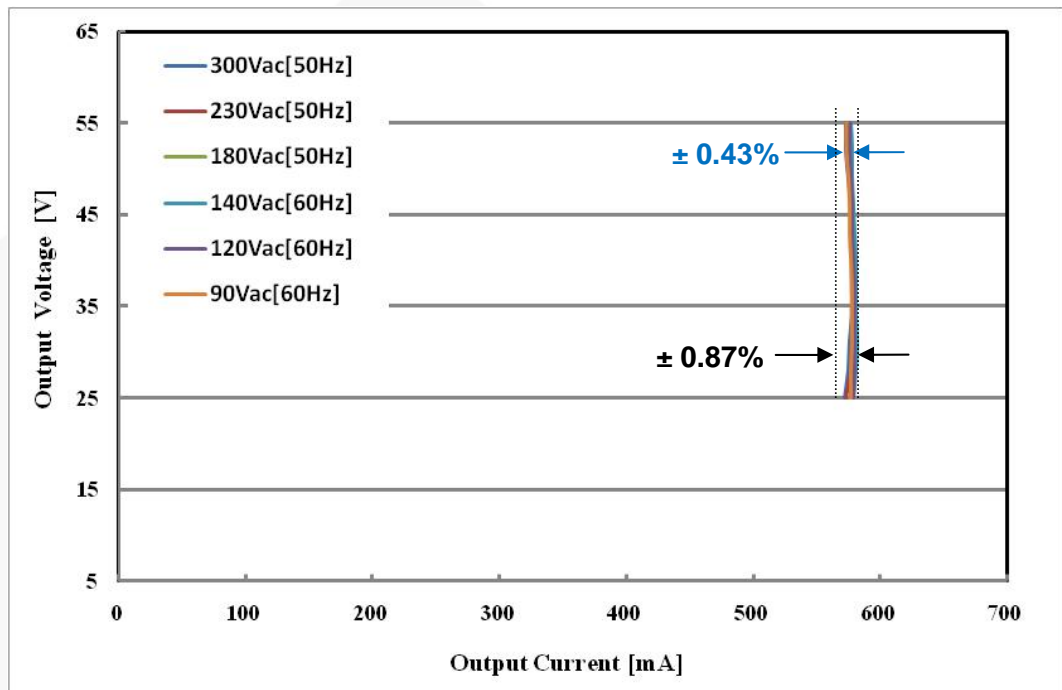

Figure 20. Constant-Current Regulation

Table 5. Constant-Current Regulation by Output Voltage Change (25 ~ 55 V)

Input Voltage	Min. Current [mA]	Max. Current [mA]	Tolerance
90 V _{AC} [60 Hz]	573	578	$\pm 0.43\%$
120 V _{AC} [60 Hz]	576	580	$\pm 0.35\%$
140 V _{AC} [60 Hz]	577	582	$\pm 0.43\%$
180 V _{AC} [50 Hz]	575	581	$\pm 0.52\%$
230 V _{AC} [50 Hz]	573	580	$\pm 0.61\%$
300 V _{AC} [50 Hz]	572	578	$\pm 0.52\%$

Table 6. Constant-Current Regulation by Line Voltage Change (90 ~ 300 V_{AC})

Output Voltage	90 V _{AC} [60 Hz]	120 V _{AC} [60 Hz]	140 V _{AC} [60 Hz]	180 V _{AC} [50 Hz]	230 V _{AC} [50 Hz]	300 V _{AC} [50 Hz]	Tolerance
55 V	573 mA	575 mA	575 mA	577 mA	576 mA	573 mA	$\pm 0.35\%$
52 V	573 mA	575 mA	575 mA	578 mA	576 mA	573 mA	$\pm 0.43\%$
49 V	575 mA	576 mA	576 mA	578 mA	577 mA	575 mA	$\pm 0.26\%$
46 V	577 mA	578 mA	578 mA	579 mA	578 mA	576 mA	$\pm 0.26\%$

8.4. Short- / Open-LED Protections

Figure 21 to Figure 24 shows the operating waveforms when the LED short protection is triggered and recovered. Once the LED short occurs, SLP is triggered and V_{DD} starts “Hiccup” Mode with JFET regulation times [250 ms]. This lasts until the fault condition is removed. Systems can restart automatically when the output load returns to normal condition. CH1: V_{GATE} (5 V / div), CH2: V_{DD} (10 V / div), CH3: V_{IN} (200 V / div), I_{OUT} (500 mA / div), Time Scale: (1.00 s / div).

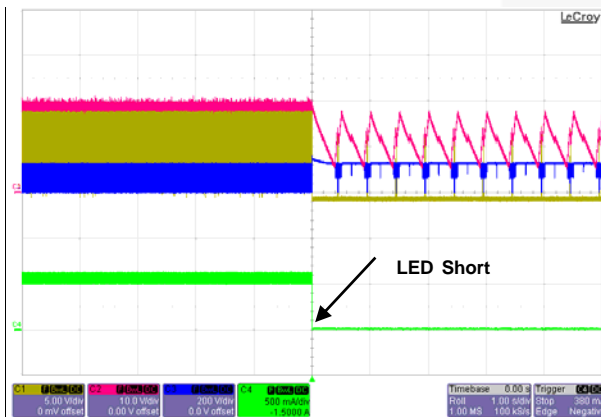

Figure 21. $V_{IN} = 90 V_{AC} / 60 \text{ Hz}$, [LED Short]

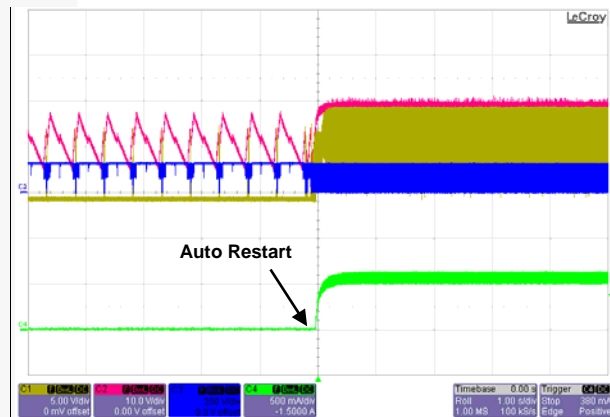

Figure 22. $V_{IN} = 90 V_{AC} / 60 \text{ Hz}$, [LED Restore]

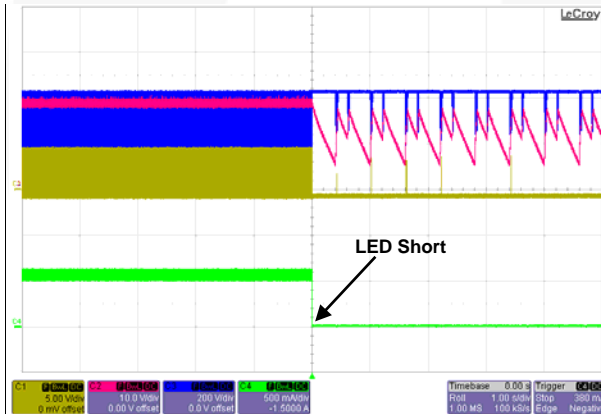

Figure 23. $V_{IN} = 300 V_{AC} / 50 \text{ Hz}$, [LED Short]

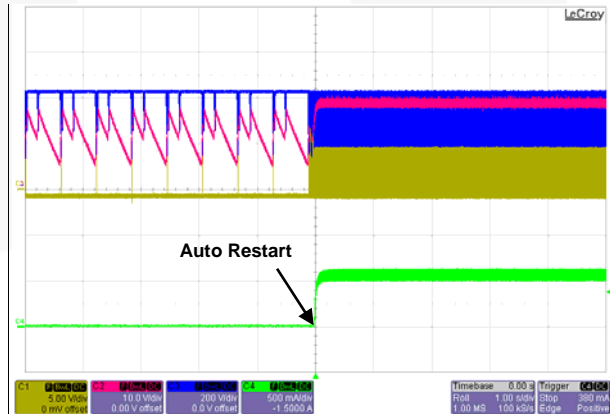

Figure 24. $V_{IN} = 300 V_{AC} / 50 \text{ Hz}$, [LED Restore]



Figure 25 to Figure 28 shows the operating waveforms when the LED open condition is triggered and recovered. Once the output goes open circuit, V_S OVP or V_{DD} OVP are triggered and V_{DD} starts Hiccup Mode with JFET regulation times [250 ms]. This lasts until the fault condition is eliminated. Systems can restart automatically when returned to normal condition. CH1: V_{GATE} (5 V / div), CH2: V_{DD} (10 V / div), CH3: V_{IN} (200 V / div), I_{OUT} (500 mA / div), Time Scale: (1.00 s / div).

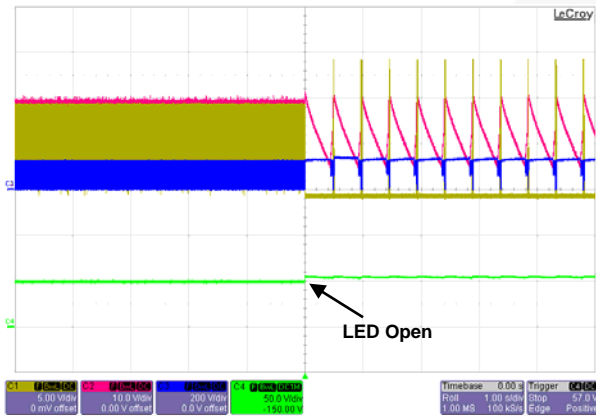

Figure 25. $V_{IN} = 90 V_{AC} / 60 Hz$, [LED Open]

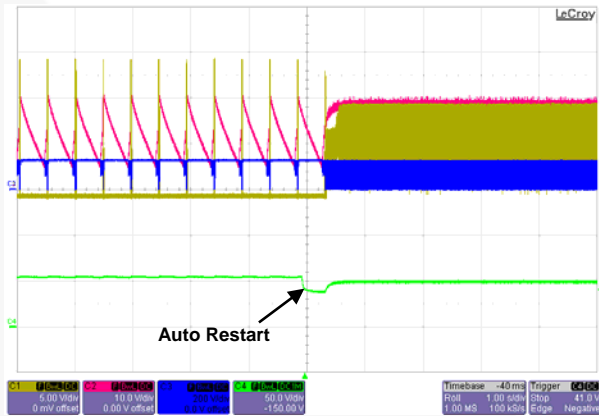

Figure 26. $V_{IN} = 90 V_{AC} / 60 Hz$, [LED Restore]

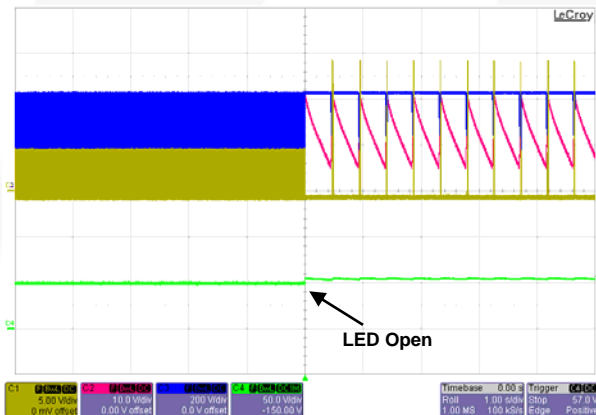

Figure 27. $V_{IN} = 300 V_{AC} / 50 Hz$, [LED Open]

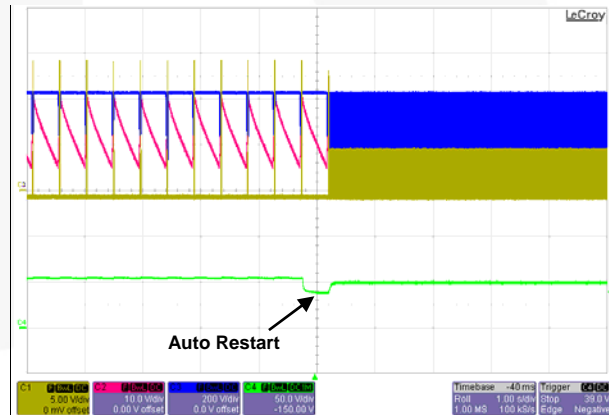

Figure 28. $V_{IN} = 300 V_{AC} / 50 Hz$, [LED Restore]

Note:

- When the LED load is re-connected after open-LED condition, the output capacitor is quickly discharged through the LED load and the inrush current by the discharge could destroy the LED load.



8.5. Analog Dimming

The FL7733A's evaluation board features analog dimming function, which is implemented with only a few external components. The converter output current at the rated line voltage can be adjusted within the range of 10% to 100% of the nominal current value through 0 to 10 V A-DIM signal as shown in Figure 29.

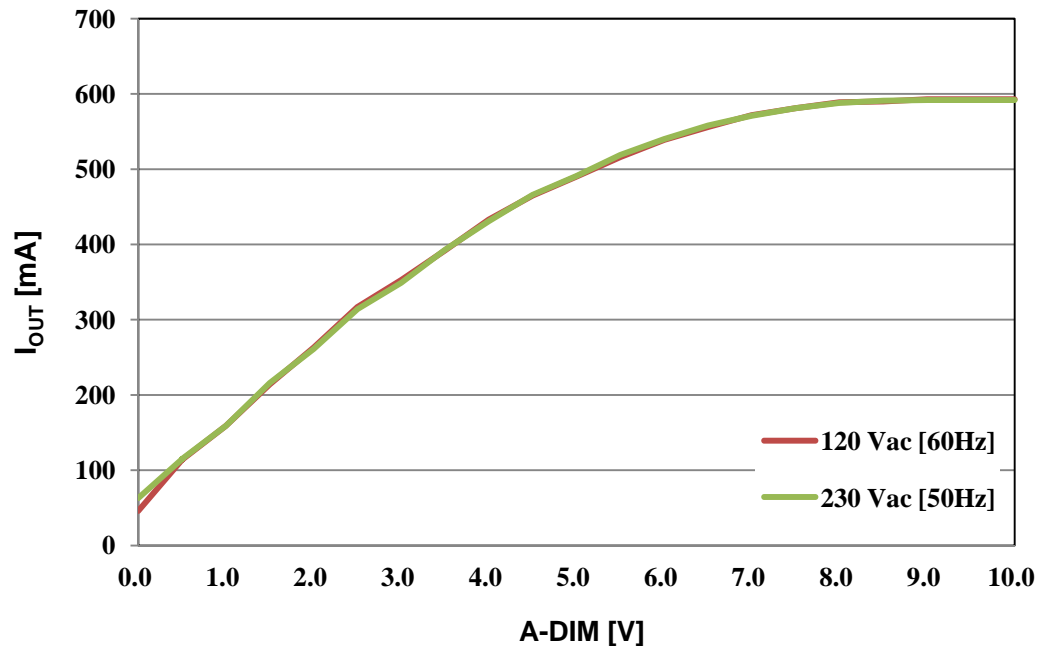

Figure 29. Analog Dimming

External Circuits for Analog Dimming

Analog dimming function can be implemented by controlling COMI voltage which determines the turn-on time of main power MOSFET. Figure 30 shows an example analog dimming circuit for the FL7733A which uses a photo-coupler so the LED current can be controlled by the dimming signal, A-Dim, at the secondary side of the isolation transformer. To control A-Dim signal with voltage range from 0 to 10 V in secondary side, the certain DC voltage regulated may be used and it can be used to control LED brightness with variable resistor as shown in Figure 31. When A-dim voltage is zero, diode current (I_D) of a photo-coupler is increased by R2 value and COMI voltage (V_{COMI}) charged at COMI capacitor (C_{COMI}) is discharged by transistor of the photo-coupler and then LED current is reduced because V_{COMI} level determines turn on time of main power MOSFET. In addition, I_D can be controlled by variable resistor that rotates user friendly and closed A-Dim terminal.

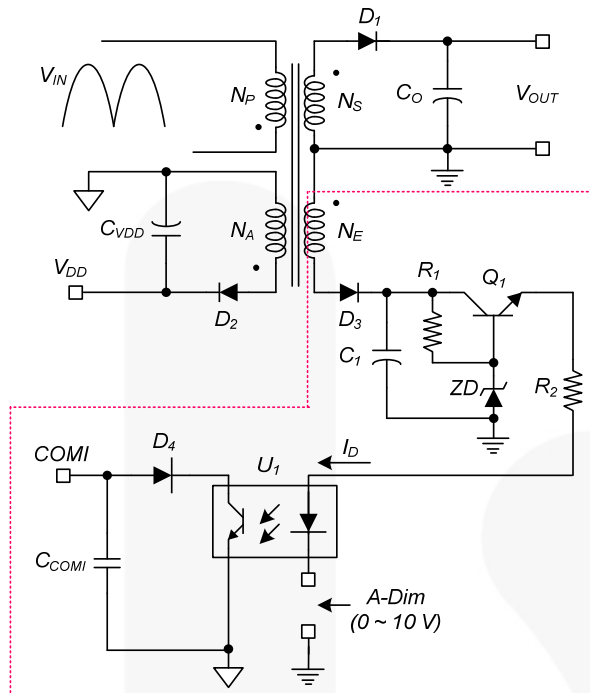

Figure 30. Analog Dimming by A-DIM Voltage

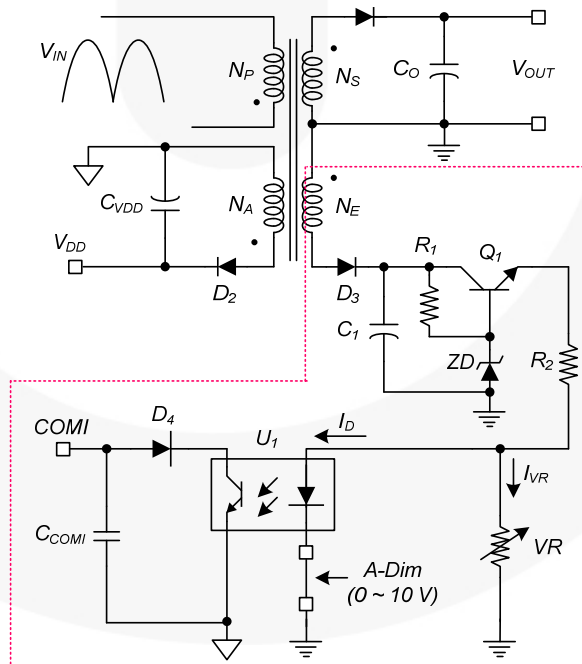

Figure 31. Analog Dimming by Variable Resistor

8.6. Efficiency

System efficiency is 89.46% ~ 91.01% over input voltages 90 ~ 300 V_{AC}. The results were measured using actual rated LED loads 30 minutes after startup.

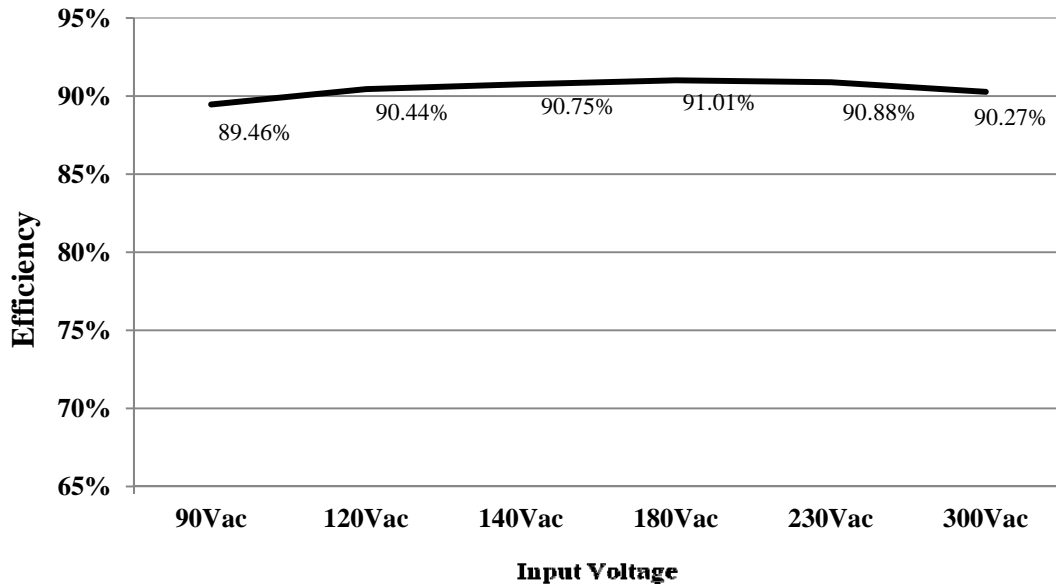

Figure 32. System Efficiency

Table 7. System Efficiency

Input Voltage	Input Power (W)	Output Current (A)	Output Voltage (V)	Output Power (W)	Efficiency (%)
90 V _{AC} [60 Hz]	33.03	0.576	51.31	29.55	89.46
120 V _{AC} [60 Hz]	32.70	0.577	51.30	29.57	90.44
140 V _{AC} [60 Hz]	32.63	0.577	51.30	29.61	90.75
180 V _{AC} [50 Hz]	32.63	0.579	51.29	29.70	91.01
230 V _{AC} [50 Hz]	32.65	0.579	51.25	29.67	90.88
300 V _{AC} [50 Hz]	32.86	0.579	51.23	29.66	90.27

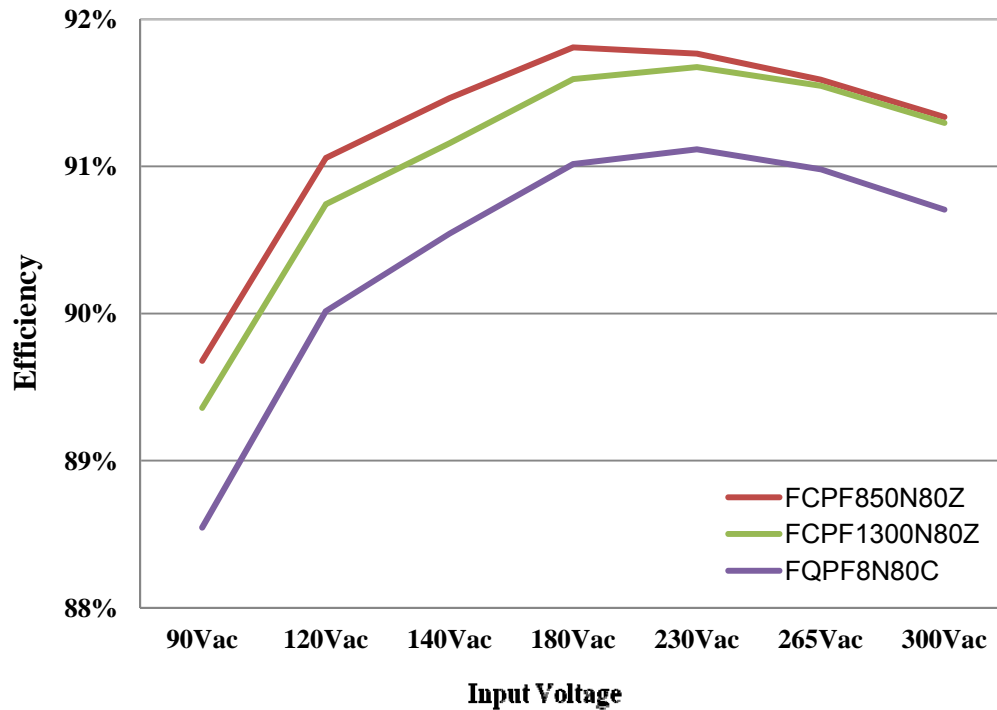

Figure 33. System Efficiency

Fairchild’s super-junction devices utilizing the charge balance theory can reduce the on-resistance of high voltage MOSFETs. Since conduction losses are directly proportional to on-resistance, it can provide a great advantage for conduction losses in low line input conditions especially. In addition, faster switching transients of super junction MOSFET can reduce switching losses occurred by parasitic capacitances during switching transients. System efficiency can vary according to MOSFET types over input voltages 90 ~ 300 V_{AC}.



8.7. Power Factor (PF) & Total Harmonic Distortion (THD)

The FL7733A's evaluation board shows excellent PF and THD performance. The results were measured using actual rated LED loads 30 minutes after startup.

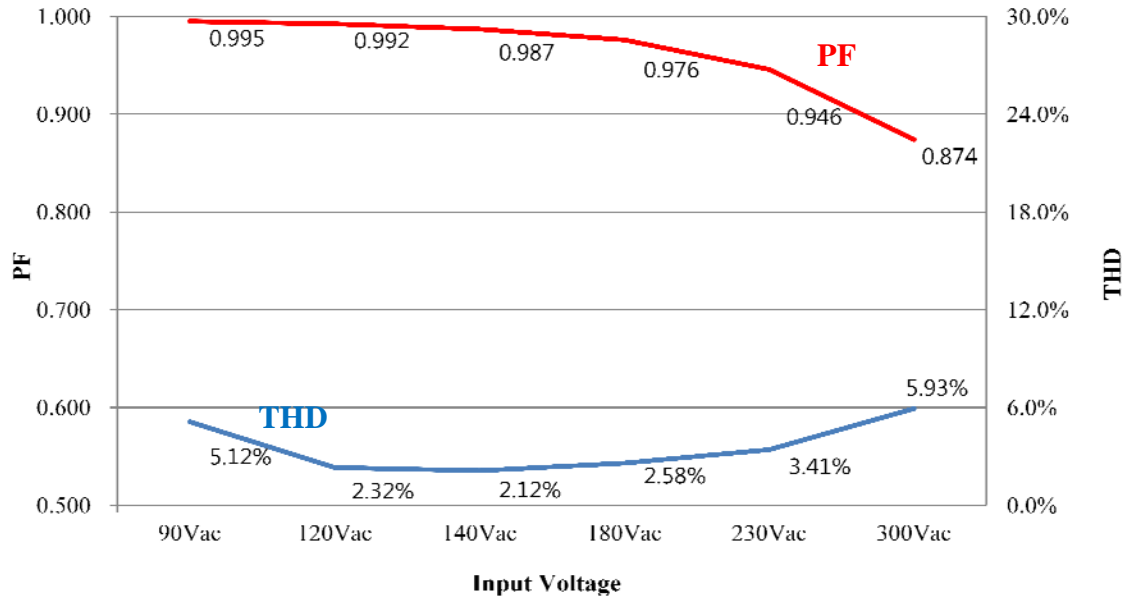

Figure 34. Power Factor & Total Harmonic Distortion

Table 8. Power Factor & Total Harmonic Distortion

Input Voltage	Output Current (A)	Output Voltage (V)	Power Factor	THD (%)
90 V _{AC} [60 Hz]	0.576	51.31	0.995	5.12
120 V _{AC} [60 Hz]	0.577	51.30	0.992	2.32
140 V _{AC} [60 Hz]	0.577	51.30	0.987	2.12
180 V _{AC} [50 Hz]	0.579	51.29	0.976	2.58
230 V _{AC} [50 Hz]	0.579	51.25	0.946	3.41
300 V _{AC} [50 Hz]	0.579	51.23	0.874	5.93

8.8. Harmonics

Figure 35 to Figure 38 show current harmonics measured using actual rated LED loads.

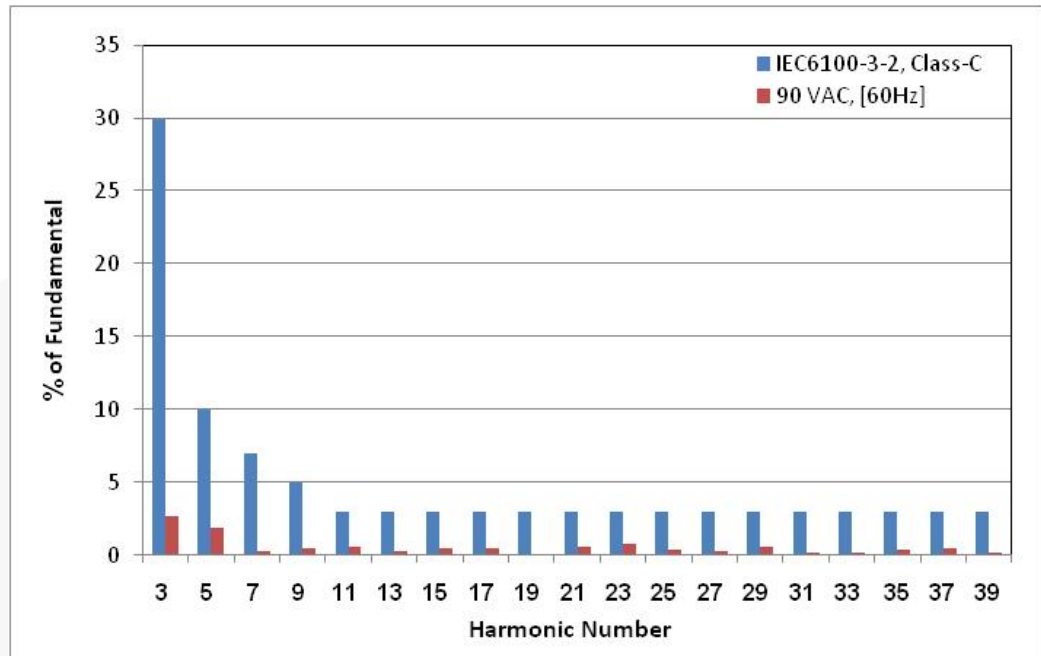

Figure 35. $V_{IN} = 90 V_{AC} / 60 Hz$

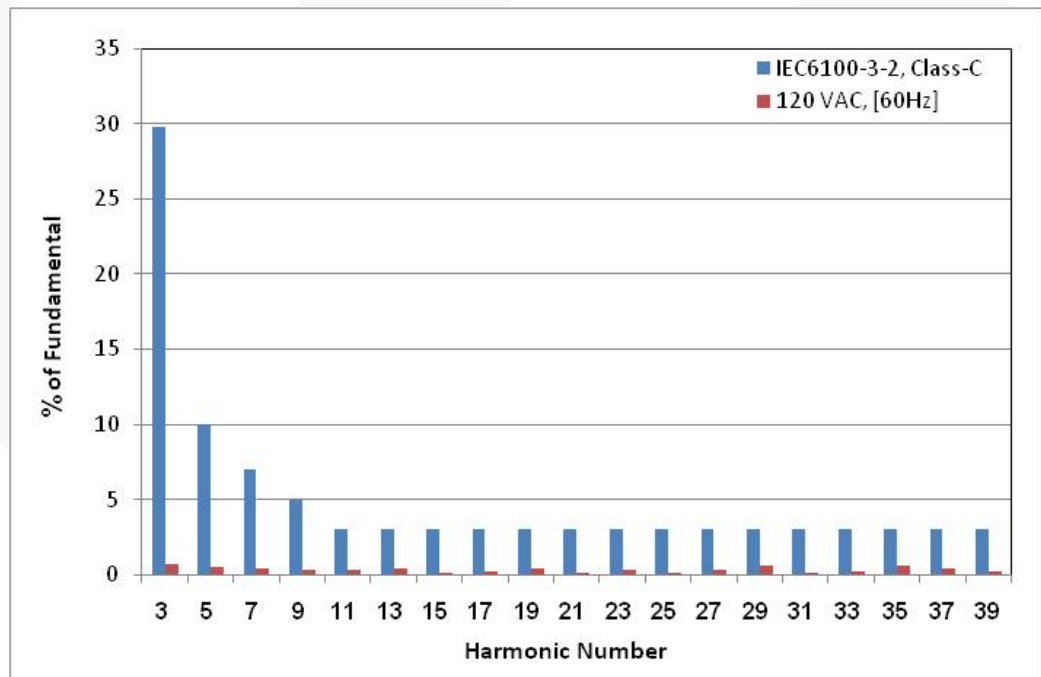

Figure 36. $V_{IN} = 120 V_{AC} / 60 Hz$

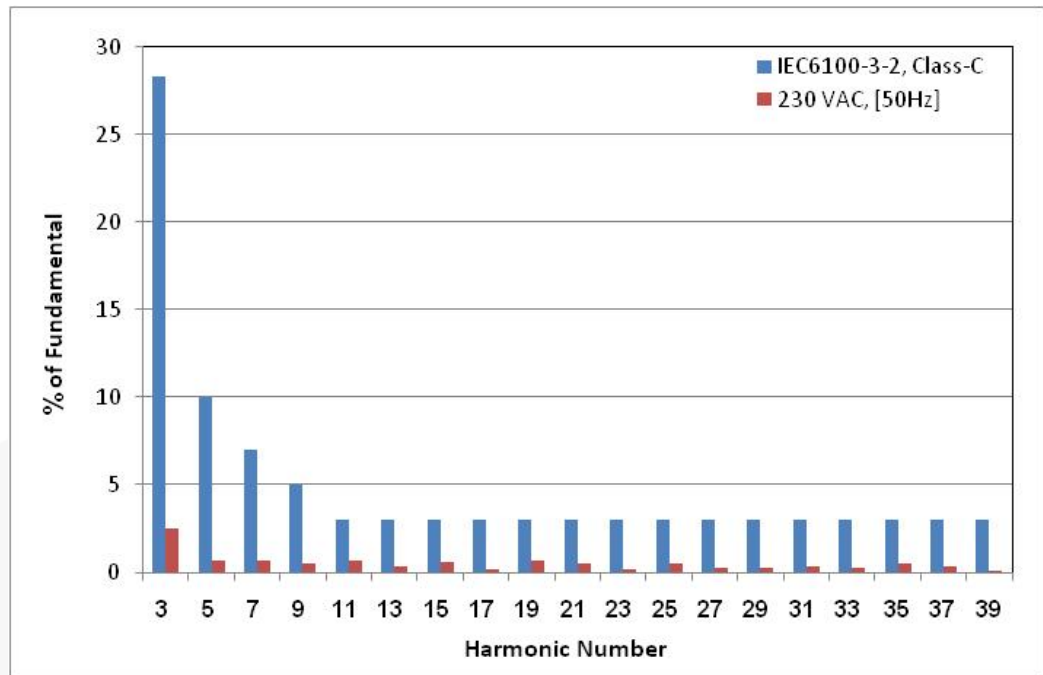

Figure 37. $V_{IN} = 230 V_{AC} / 50 Hz$

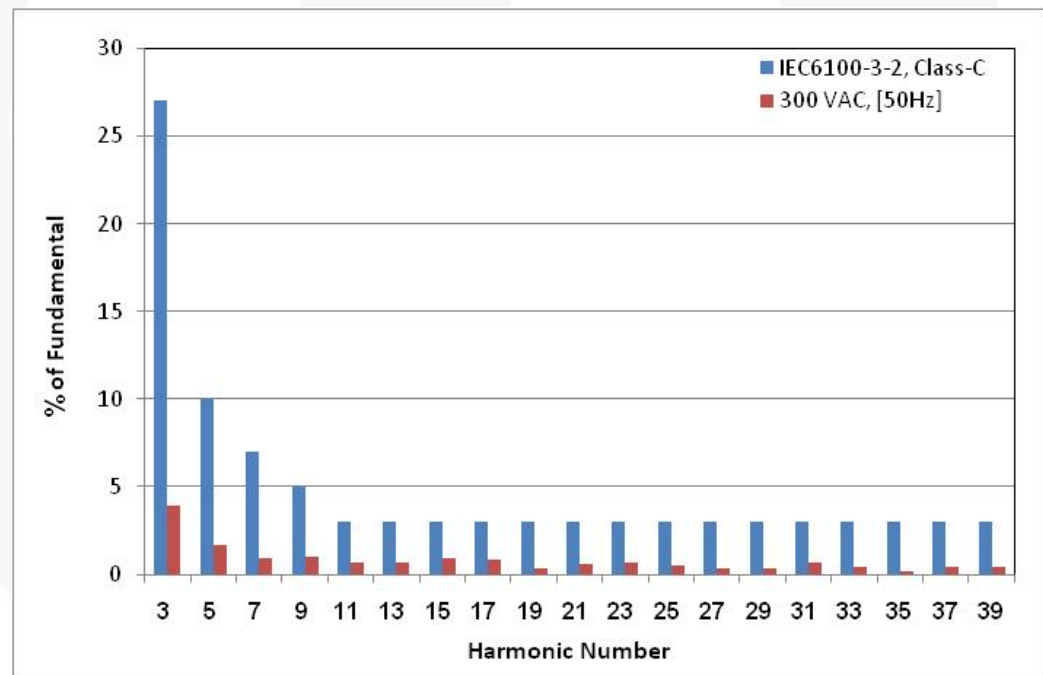

Figure 38. $V_{IN} = 300 V_{AC} / 50 Hz$

8.9. Operating Temperature

The results were measured using actual rated LED loads 60 minutes after startup.

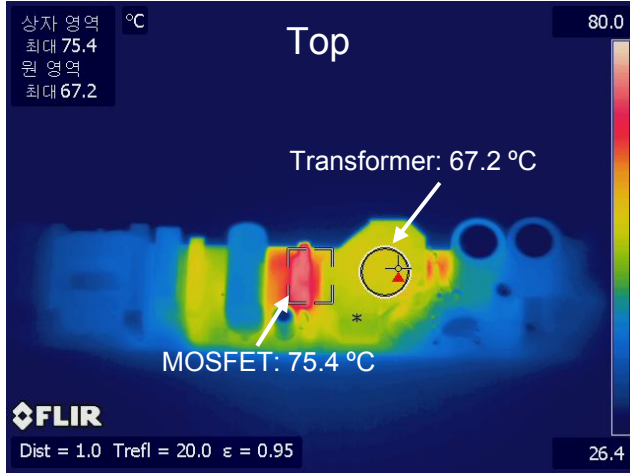

Figure 39. $V_{IN} = 90 V_{AC} / 60 Hz$

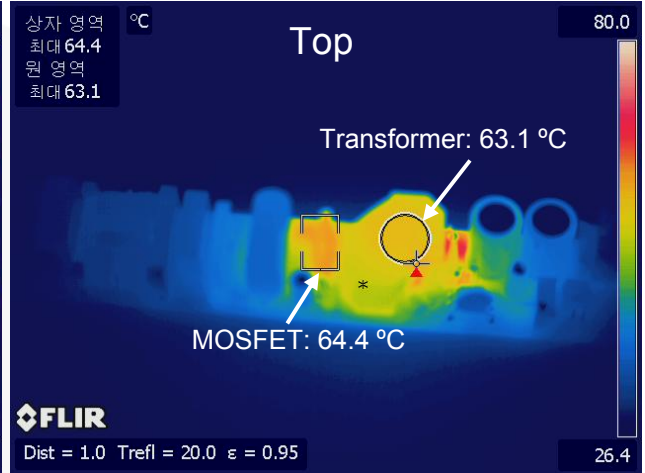

Figure 40. $V_{IN} = 300 V_{AC} / 50 Hz$

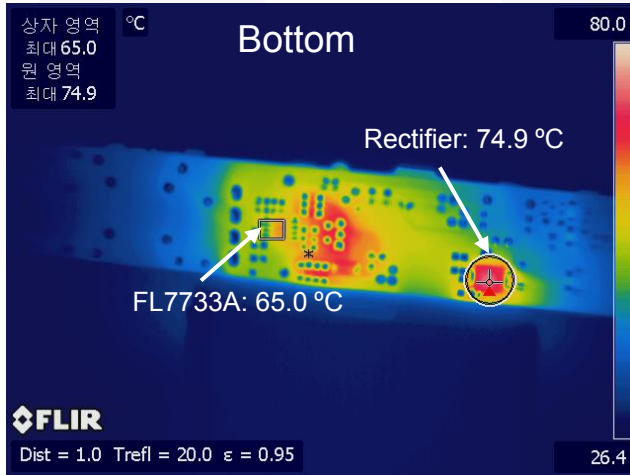

Figure 41. $V_{IN} = 90 V_{AC} / 60 Hz$

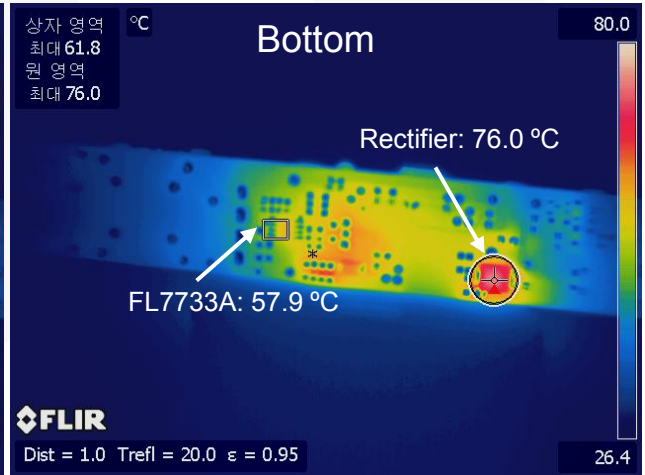

Figure 42. $V_{IN} = 300 V_{AC} / 50 Hz$

Note:

- The IC temperature can be improved by the PCB layout.

8.10. Electromagnetic Interference (EMI)

All measurements were conducted in observance of EN55022 criteria.

The results were measured using actual rated LED loads 30 minutes after startup.

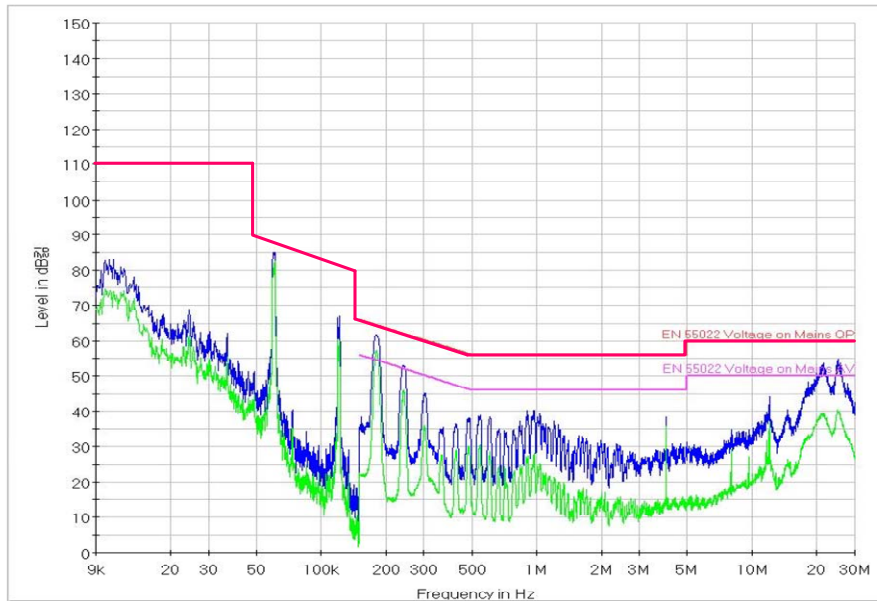

Figure 43. V_{IN} [110 V_{AC}, Neutral]

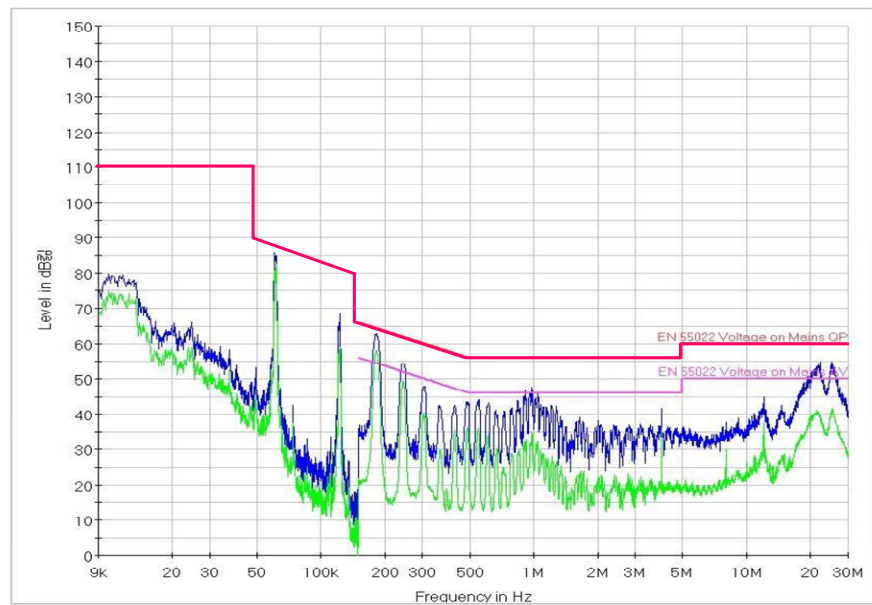

Figure 44. V_{IN} [220 V_{AC}, Live]



9. Revision History

Rev.	Date	Description
1.0	Oct. 2014	Initial Release

WARNING AND DISCLAIMER

Replace components on the Evaluation Board only with those parts shown on the parts list (or Bill of Materials) in the Users' Guide. Contact an authorized Fairchild representative with any questions.

The Evaluation board (or kit) is for demonstration purposes only and neither the Board nor this User's Guide constitute a sales contract or create any kind of warranty, whether express or implied, as to the applications or products involved. Fairchild warrants that its products meet Fairchild's published specifications, but does not guarantee that its products work in any specific application. Fairchild reserves the right to make changes without notice to any products described herein to improve reliability, function, or design. Either the applicable sales contract signed by Fairchild and Buyer or, if no contract exists, Fairchild's standard Terms and Conditions on the back of Fairchild invoices, govern the terms of sale of the products described herein.

DISCLAIMER

FAIRCHILD SEMICONDUCTOR RESERVES THE RIGHT TO MAKE CHANGES WITHOUT FURTHER NOTICE TO ANY PRODUCTS HEREIN TO IMPROVE RELIABILITY, FUNCTION, OR DESIGN. FAIRCHILD DOES NOT ASSUME ANY LIABILITY ARISING OUT OF THE APPLICATION OR USE OF ANY PRODUCT OR CIRCUIT DESCRIBED HEREIN; NEITHER DOES IT CONVEY ANY LICENSE UNDER ITS PATENT RIGHTS, NOR THE RIGHTS OF OTHERS.

LIFE SUPPORT POLICY

FAIRCHILD'S PRODUCTS ARE NOT AUTHORIZED FOR USE AS CRITICAL COMPONENTS IN LIFE SUPPORT DEVICES OR SYSTEMS WITHOUT THE EXPRESS WRITTEN APPROVAL OF THE PRESIDENT OF FAIRCHILD SEMICONDUCTOR CORPORATION.

As used herein:

1. Life support devices or systems are devices or systems which, (a) are intended for surgical implant into the body, or (b) support or sustain life, or (c) whose failure to perform when properly used in accordance with instructions for use provided in the labeling, can be reasonably expected to result in significant injury to the user.
2. A critical component is any component of a life support device or system whose failure to perform can be reasonably expected to cause the failure of the life support device or system, or to affect its safety or effectiveness.

ANTI-COUNTERFEITING POLICY

Fairchild Semiconductor Corporation's Anti-Counterfeiting Policy. Fairchild's Anti-Counterfeiting Policy is also stated on our external website, www.fairchildsemi.com, under Sales Support.

Counterfeiting of semiconductor parts is a growing problem in the industry. All manufacturers of semiconductor products are experiencing counterfeiting of their parts. Customers who inadvertently purchase counterfeit parts experience many problems such as loss of brand reputation, substandard performance, failed applications, and increased cost of production and manufacturing delays. Fairchild is taking strong measures to protect ourselves and our customers from the proliferation of counterfeit parts. Fairchild strongly encourages customers to purchase Fairchild parts either directly from Fairchild or from Authorized Fairchild Distributors who are listed by country on our web page cited above. Products customers buy either from Fairchild directly or from Authorized Fairchild Distributors are genuine parts, have full traceability, meet Fairchild's quality standards for handling and storage and provide access to Fairchild's full range of up-to-date technical and product information. Fairchild and our Authorized Distributors will stand behind all warranties and will appropriately address any warranty issues that may arise. Fairchild will not provide any warranty coverage or other assistance for parts bought from Unauthorized Sources. Fairchild is committed to combat this global problem and encourage our customers to do their part in stopping this practice by buying direct or from authorized distributors.